

Frequency Inverter

Convertidor de Frecuencia

Inversor de Frequência

Frequenzumrichter

Variateur de Vitesse

Преобразователь частоты

Frequentie regelaar

Convertitore di Frequenza

CFW-11

Installation Guide
Guía de Instalación
Guia de Instalação
Installationsanleitung
Guide Rapide D'Installation
Руководство по установке
Installatiehandleiding
Guida di Installazione

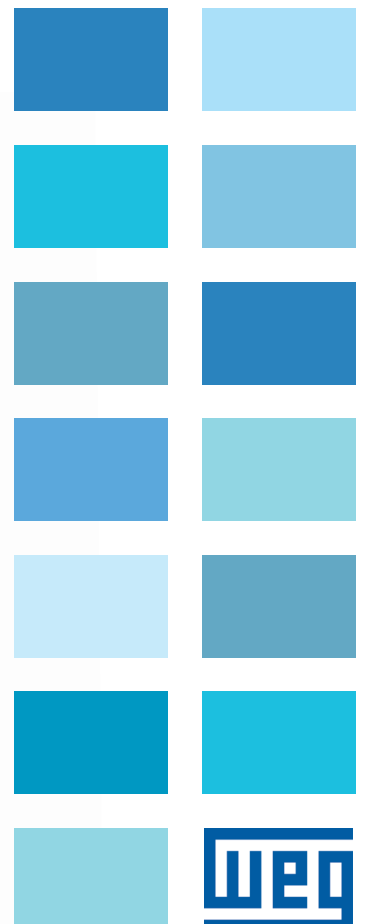



Frequency Inverter

Installation Guide

Series: CFW-11

Language: English

Document: 10001803811 / 00

Publication Date: 01/2013

ENGLISH

ESPAÑOL

PORTUGUÊS

DEUTSCH

FRANÇAIS

РУССКИЙ

NEDERLANDS

ITALIANO

CONTENTS

ABOUT THIS GUIDE.....	7
SAFETY INSTRUCTIONS.....	7
CFW-11 MAIN DESCRIPTION.....	7
RECEIVING AND STORAGE	7
MECHANICAL INSTALLATION	7
GENERAL MOUNTING CONSIDERATIONS.....	7
CABINET MOUNTING	7
ELECTRICAL INSTALLATION	10
CONNECTION DIAGRAMS.....	10
NOTES ON CIRCUITS AND DEVICES	11
IT NETWORKS.....	12
GROUNDING CONNECTIONS.....	12
CONTROL CONNECTIONS.....	13
INSTALLATION ACCORDING TO THE EUROPEAN DIRECTIVE OF ELECTROMAGNETIC COMPATIBILITY	15
INTEGRAL KEYPAD - HMI-CFW11	16
PARAMETER STRUCTURE	17
START-UP	17
BEFORE ENERGIZING.....	17
STARTING UP IN V/F MODE.....	17
DATE AND TIME SETTING.....	18
PARAMETER CHANGE PREVENTION.....	18
FLASH MEMORY MODULE FUNCTIONS	18
APPENDIX 1 – TECHNICAL SPECIFICATIONS.....	19

ABOUT THIS GUIDE

This guide shows how to install and how to start-up in V/f mode the CFW-11 inverter models from frame size A to G.

For detailed information please refer to the CFW-11 user's manual and programming manual.

It is also possible to operate the CFW-11 in the following control modes: VVW, Sensorless Vector Control and Vector Control with Encoder, for induction motors and Sensorless and Encoder Vector Control for Permanent Magnet (PM) machines. Please see the programming manual.

For information on other functions, accessories and communication, please see the WEG website www.weg.net for manual downloads.

SAFETY INSTRUCTIONS

Fully read this guide before installing or operating the inverter.

Only trained and qualified personnel should attempt to install, start-up, and troubleshoot this type of equipment. The personnel must follow all the safety instructions described in this guide and/or defined by the local regulations.



⚠ DANGER!
Failure to comply with the safety instructions may result in death, serious injury, and equipment damage. Always disconnect the main power supply before touching any electrical device associated to the inverter.
Several components can remain charged with high voltage and/or in movement (fans), even after the AC power supply has been disconnected or switched off. Wait at least 10 minutes to assure the total discharge of the capacitors.
Always connect the equipment frame to the protection earth (PE).



✔ NOTE!
For the purpose of this guide, qualified personnel are those trained and able to:

1. Install, ground, power-up, and operate the CFW-11 according to this guide and to the current legal safety procedures.
2. Use the protection equipment according to the established regulations.
3. Provide first aid.



✔ NOTE!
Frequency inverter may interference with other electronic equipment. Follow the installation instructions for minimizing these effects.

CFW-11 MAIN DESCRIPTION

The CFW-11 frequency inverter is a high performance product with models covering the range from 1 to 600 HP (0.75 to 450 kW) in seven different mechanical sizes and line voltages from 200 V to 480 V. It is designed for speed and torque control of three-phase induction motors and PM motors. The main characteristic of this product is the “Vectrue” technology, with the following control modes: Scalar control (V/f), VVW, “Sensorless vector control” and “Vector control with encoder”. Additional highlight functions and features: “Optimal Braking”, “Self-Tuning” and “Optimal Flux”.

For more detailed information refer to the CFW-11 user's manual and the programming manual.

RECEIVING AND STORAGE

When receiving the product verify if:

The CFW-11 nameplate data matches the purchase order. See models and technical characteristic in [tables A.1](#) and [A.2](#).

Any damage occurred during transportation. If any problem is detected, contact the carrier immediately.

If the CFW-11 is not to be installed immediately, store it within its original cardboard box in a clean and dry room (storage temperatures between -25 °C (-13 °F) and 60 °C (140 °F)).

MECHANICAL INSTALLATION

ENVIRONMENT

Avoid:

- Direct exposure to sunlight, rain, high humidity, or sea-air.
- Inflammable or corrosive gases or liquids.
- Excessive vibration.
- Dust, metallic particles, and oil mist.
- Environment conditions according to [tables A.1](#) and [A.2](#).

GENERAL MOUNTING CONSIDERATIONS

Consult the inverter weight in [tables A.1](#) and [A.2](#).

Mount the inverter in the upright position on a flat and vertical surface.

External dimensions and fixing holes position according to the [figure 1](#).

Minimum mounting clearances requirements for proper cooling air circulation are specified in [figure 2](#).

Note:

- For sizes A, B, and C: side-by-side mounting - no clearance required between inverters if top cover is removed.

Do not install heat sensitive components right above the inverter.

CABINET MOUNTING

Surface assembly:

Provide adequate exhaustion so that the internal cabinet temperature remains within the allowed range for the inverter operations conditions.

The power dissipated by the inverter at its rated condition is specified in [table A.1](#) and [A.2](#) “Dissipated power in Watts – Surface Mounting”.

The cabinet minimum air cooling flow requirements are as shown in [table 1](#).

The position and diameter of the mounting holes are according to figure 1.

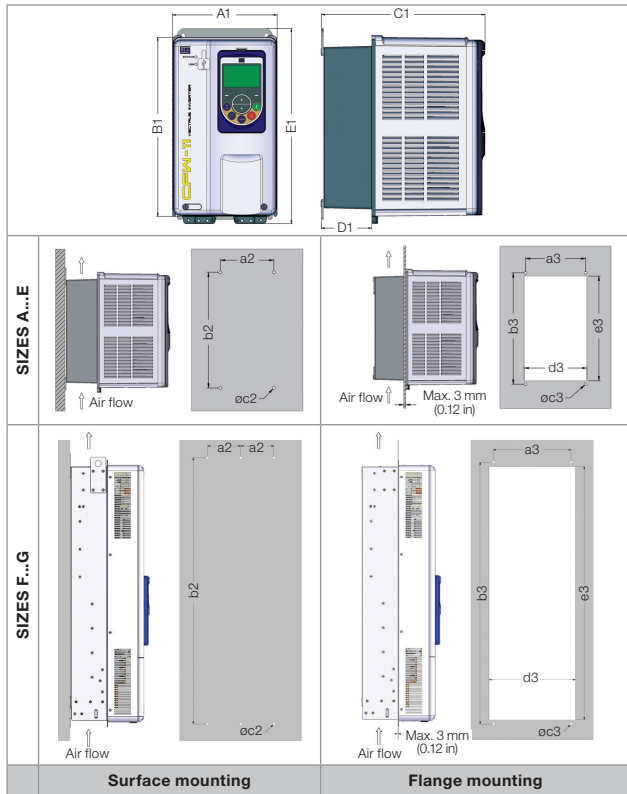

Model	A1	B1	C1	D1	E1	a2	b2	c2	a3	b3	c3	d3	e3
	mm (in)	mm (in)	mm (in)	mm (in)	mm (in)	mm (in)	mm (in)	M	mm (in)	mm (in)	M	mm (in)	mm (in)
Size A	145 (5.71)	247 (9.73)	227 (8.94)	70 (2.75)	270 (10.63)	115 (4.53)	250 (9.85)	M5	130 (5.12)	240 (9.45)	M5	135 (5.32)	225 (8.86)
Size B	190 (7.48)	293 (11.53)	227 (8.94)	71 (2.78)	316 (12.43)	150 (5.91)	300 (11.82)	M5	175 (6.89)	285 (11.23)	M5	179 (7.05)	271 (10.66)
Size C	220 (8.67)	378 (14.88)	293 (11.53)	136 (5.36)	405 (15.95)	150 (5.91)	375 (14.77)	M6	195 (7.68)	365 (14.38)	M6	205 (8.08)	345 (13.59)
Size D	300 (11.81)	504 (19.84)	305 (12.00)	135 (5.32)	550 (21.65)	200 (7.88)	525 (20.67)	M8	275 (10.83)	517 (20.36)	M8	285 (11.23)	485 (19.10)
Size E	335 (13.19)	620 (24.41)	358 (14.09)	168 (6.61)	675 (25.57)	200 (7.88)	650 (25.59)	M8	275 (10.83)	635 (25.00)	M8	315 (12.40)	615 (24.21)
Size F	430 (16.93)	1156 (45.51)	360 (14.17)	169 (6.65)	1234 (48.58)	150 (5.91)	1200 (47.24)	M10	350 (13.78)	1185 (46.65)	M10	391 (15.39)	1146 (45.12)
Size G	535 (21.06)	1190 (46.85)	426 (16.77)	202 (7.95)	1264 (49.76)	200 (7.87)	1225 (48.23)	M10	400 (15.75)	1220 (48.03)	M10	495 (19.49)	1182 (46.53)

Tolerance for d3 and e3: +1.0 mm (+0.039 in)
 General tolerance: ±1.0 mm (±0.039 in)

Figure 1: Mechanical installation details

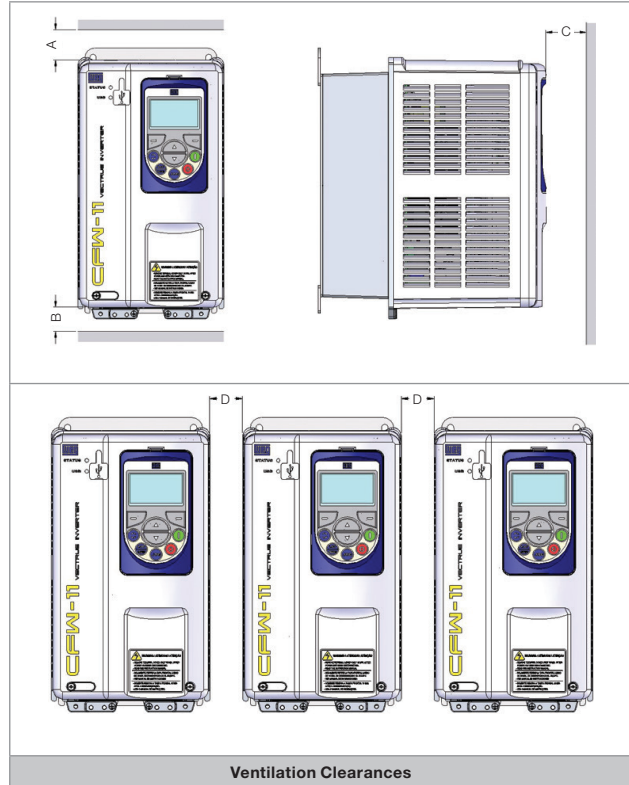

Model	A	B	C	D
	mm (in)	mm (in)	mm (in)	mm (in)
Size A	25 (0.98)	25 (0.98)	10 (0.39)	30 (1.18)
Size B	40 (1.57)	45 (1.77)		
Size C	110 (4.33)	130 (5.12)		
Size D	100 (3.94)	130 (5.12)	20 (0.78)	40 (1.57)
0142 T2				80 (3.15)
0211 T2				40 (1.57)
0105 T4				80 (3.15)
0180 T4				80 (3.15)
0211 T4	150 (5.91)	250 (9.84)		
Size F				
Size G				

Tolerance: ±1.0 mm (±0.039 in)

Figure 2: Minimum clearance for inverter ventilation

Table 1: Minimum required cabinet cooling air flow

Frame	Model	CFM	l/s	m³/min
A	ALL	18	8	0.5
B	ALL	42	20	1.2
C	ALL	96	45	2.7
D	ALL	132	62	3.7
E	CFW11 0142 T 2	138	65	3.9
	CFW11 0180 T 2	265	125	7.5
	CFW11 0211 T 2			
	CFW11 0105 T 4	138	65	3.9
	CFW11 0142 T 4	180	95	5.1
	CFW11 0180 T 4	265	125	7.5
CFW11 0211 T 4				
F	CFW11 0242 T 4	250	118	7.1
	CFW11 0312 T 4	320	151	9.1
	CFW11 0370 T 4	380	180	10.1
	CFW11 0477 T 4	460	217	13
G	CFW11 0515 T 4	680	321	19.3
	CFW11 0601 T 4			
	CFW11 0720 T 4			

Flange mounting:

The losses specified in [table A.1](#) and [A.2](#) “Dissipated power in Watts - Flange mounting” will be dissipated inside the cabinet. The remaining losses will be dissipated through the back side.

The inverter securing supports and the hoisting eyes must be removed and repositioned, in sizes E, F and G. See [figures 3](#) and [4](#).

The part of the inverter that is located outside the cabinet is rated IP54, for frame sizes A to E. For frame sizes F and G it is rated IP20.

Provide an adequate gasket for the cabinet opening to ensure that the enclosure rating is maintained. Example: silicone gasket.

Mounting surface opening dimensions and positions/diameters of the mounting holes, as shown in [figure 1](#).

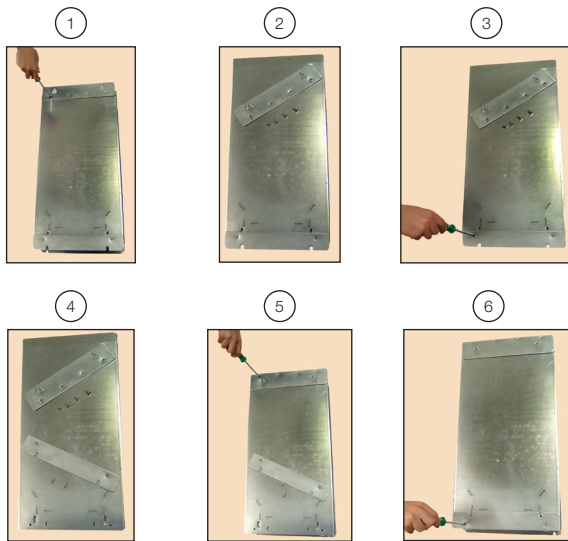

Figure 3: Repositioning of the mounting supports for sizes A to E. In sizes F and G the mounting supports must be removed

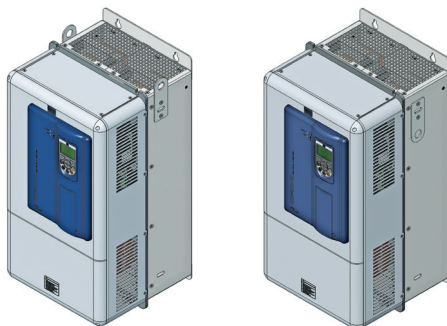

Figure 4: Hoisting Eyes installation – Sizes E, F and G

Access to the Control and Power Terminals

In order to get access to the control and power terminals, it is necessary to remove the HMI and the front cover, in sizes A to C. See [figure 5](#).

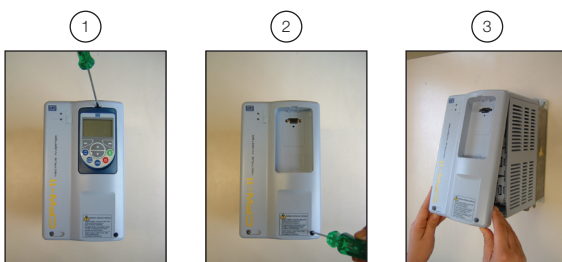

Figure 5: Removal of the HMI and the front cover

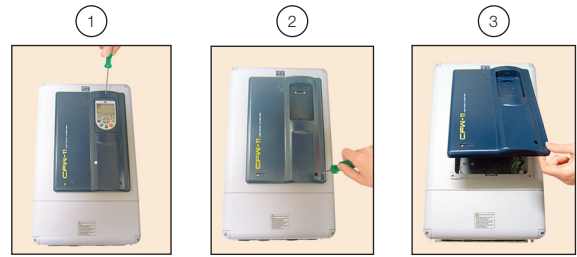

Figure 6: Removal of the HMI and the control rack cover in sizes D, E, F and G to access control terminals

In order to get access to the power terminals, it is necessary to remove the bottom front cover, as showed in [figure 7](#), in sizes D to G.

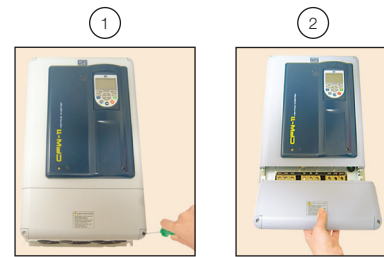

Figure 7: Removal of the bottom front cover, to access to the power terminals in sizes D to G

Where IP20 or Nema1 protection degree is unnecessary the bottom cable passage plate can be removed - sizes D and E.

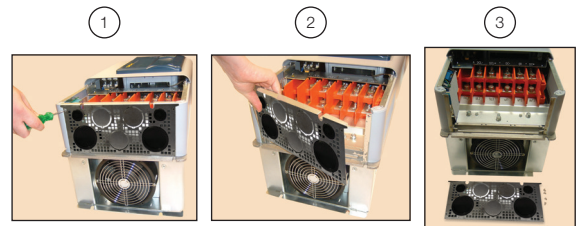

Figure 8: Removal of the cable passage plate

In sizes F and G always remove the bottom plate for connecting power cables (line and motor), as showed in the [figure 9](#).

In this case the protection degree of the inverter bottom part will be reduced.

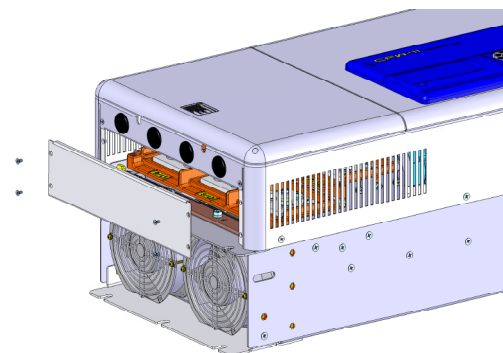

Figure 9: Removal of the cable passage plate on sizes F and G

ELECTRICAL INSTALLATION

DANGER!
Make sure the AC power supply is disconnected before starting the installation.

DANGER!
The following information is merely a guide for proper installation. Comply with applicable local regulations for electrical installations.

DANGER!
The inverter will be damaged in case the input power supply is connected to the output terminals.

CONNECTION DIAGRAMS

Notes:
Technical specifications including line fuses are on [tables A.1](#) and [A.2](#).

Technical specification of braking resistors and braking currents on [table A.3](#).

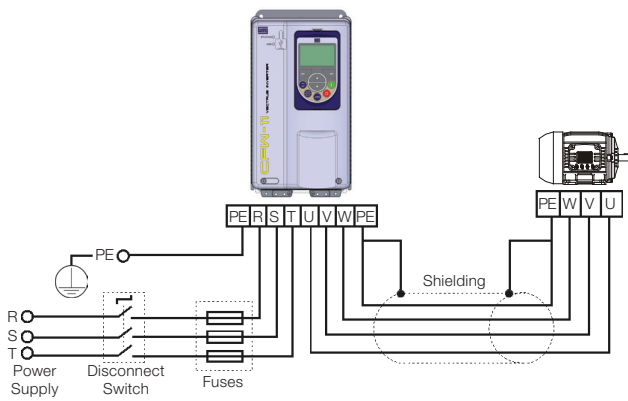

Figure 10: Power connection diagram for sizes A, B, C, D, E, F and G standard frames

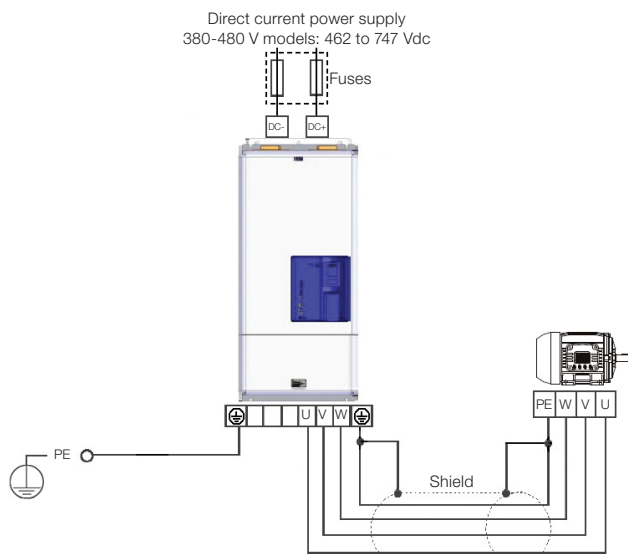

Figure 11: Power connection diagram for sizes F and G with Special DC Hardware

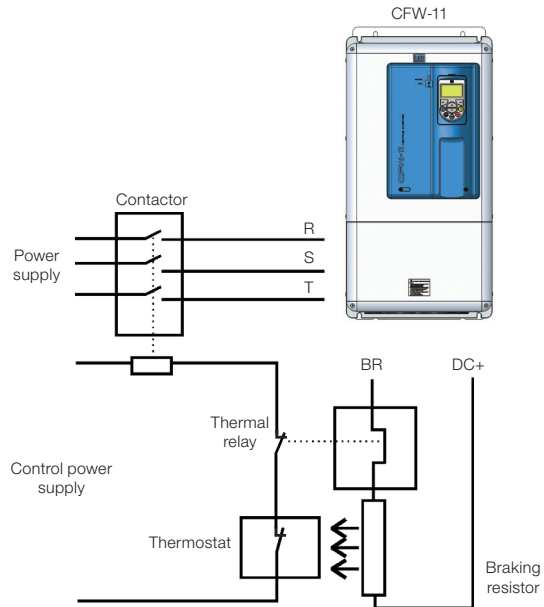

Figure 12: Braking resistor connection diagram for sizes A, B, C, D and E

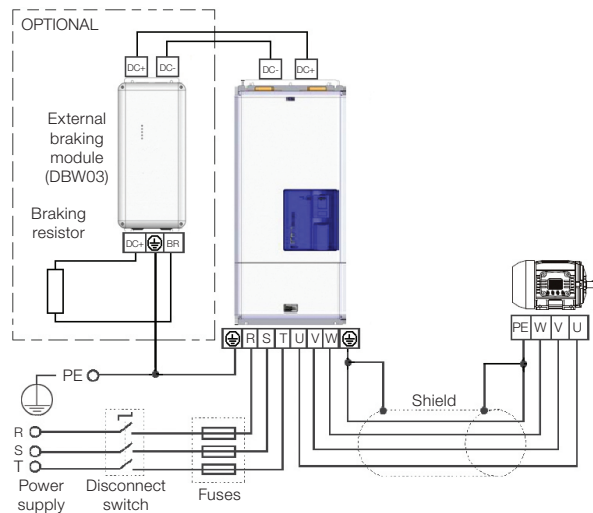

Figure 13: Power connection diagram for sizes F and G standard with braking resistor

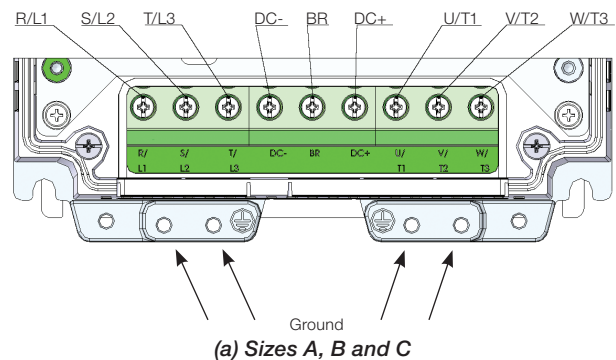

Figure 14 (a): Power and grounding terminals sizes A to C

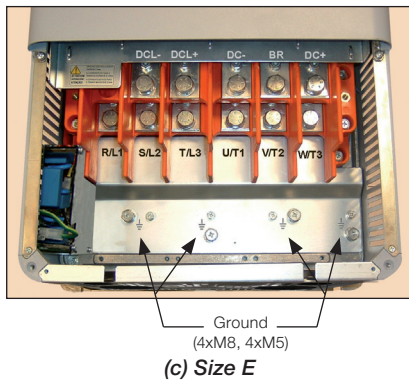
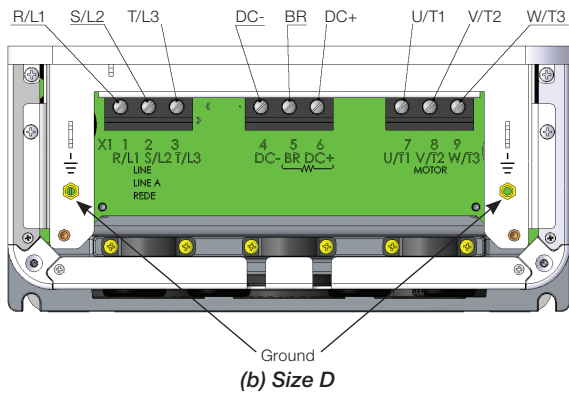

Figure 14 (b) and (c): Power and grounding terminals sizes D and E

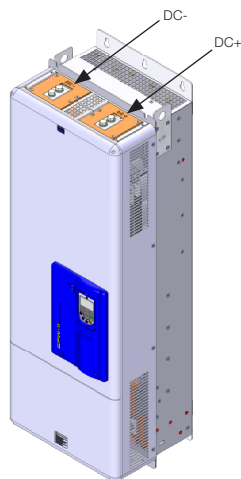
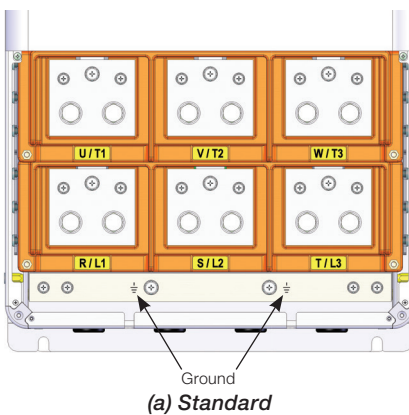

Figure 15 (a) and (b): Power and grounding terminals sizes F and G

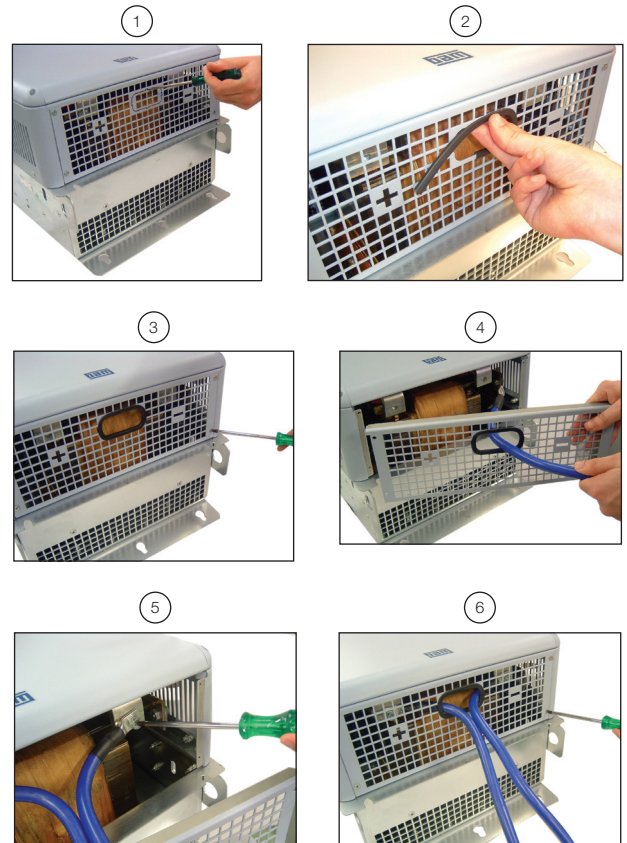

Figure 16: Connection of dynamic braking module in standard models of sizes F and G

NOTES ON CIRCUITS AND DEVICES

- The power supply that feeds the inverter must have a grounded neutral. For IT networks some internal components must be disconnected as shown in figures 17 to 19.
- Provide a disconnect device for the input power supply of the inverter. This device must disconnect the input power supply for the inverter when needed (for instance, during servicing).
- Use high speed fuses at the input for the protection of the inverter rectifier and wiring. Refer to tables A.1 and A.2 for selecting the appropriate fuse rating (I^2t must be equal to or less than indicated in tables, considering the cold (and not the fusion) current extinction value).
- In order to meet UL requirements, use class J fuses at the inverter supply with a current not higher than the values of tables A.1 and A.2.
- Optionally, slow blow fuses can be used at the input. They must be sized for 1.2 x the rated input current of the inverter. In this case, the installation is protected against short-circuit, but not the inverter input rectifier. This may result in higher damage to the inverter in the event of an internal component failure.
- The CFW-11 inverters are suitable for use on a circuit capable of delivering up to a maximum of 100.000 Arms symmetrical (230 V / 480 V).
- Motor shielded cable recommended according to IEC 60034-25.
- Keep motor cables at least 25 cm (9.84 in) distant from other cables as signal cables, sensor cables, control cables, etc.

IT NETWORKS

When the neutral is not grounded, or the grounding is provided by a high ohm value resistor or in grounded delta networks (“delta corner earth”).

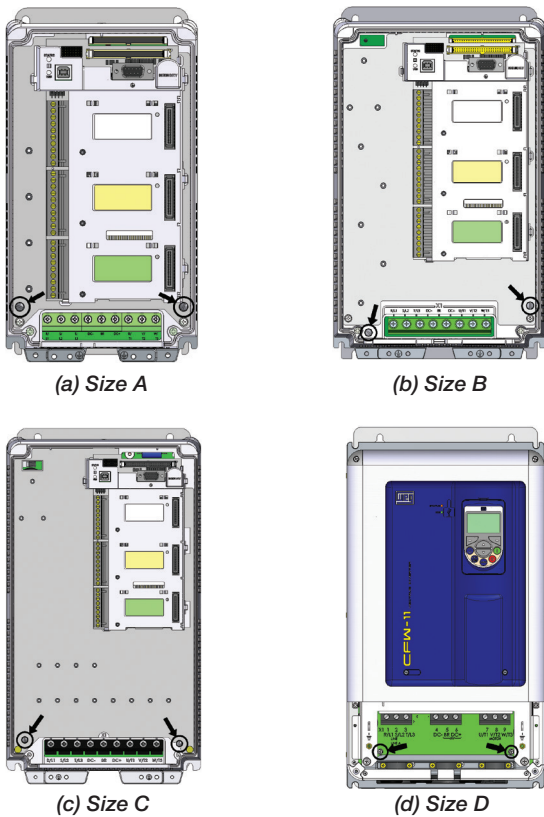
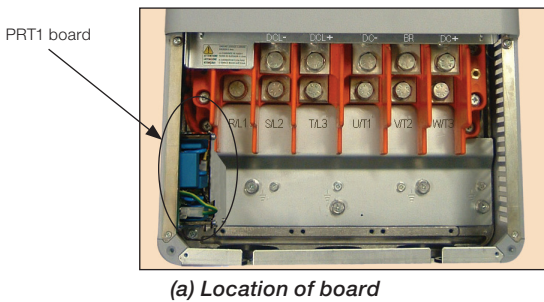
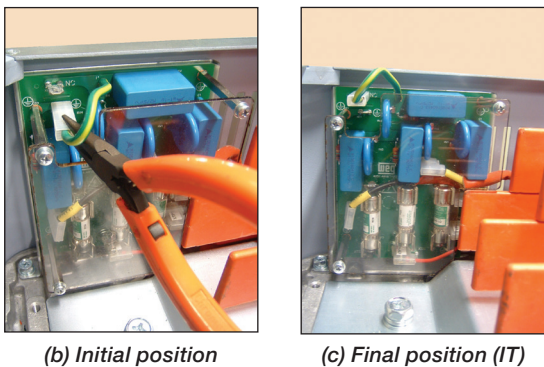

Figure 17 (a) to (d): Sizes A to D - Location of Grounding Screws - Remove for IT networks



(a) Location of board



(b) Initial position

(c) Final position (IT)

Figure 18 (a) to (c): Size E - Location of terminal on PRT1 board - Change position for IT networks

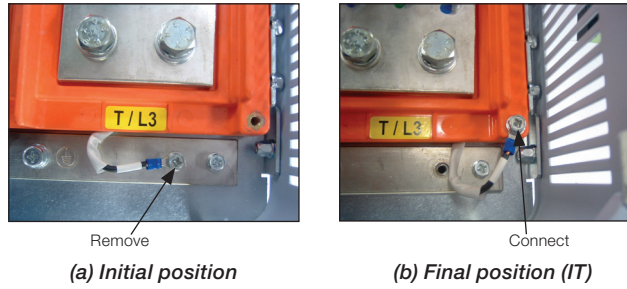

(a) Initial position

(b) Final position (IT)

Figure 19 (a) and (b): Sizes F and G - Location of terminal on PRT1 board - change position for IT networks

GROUNDING CONNECTIONS

DANGER!

The inverter ground must be connected to a protective ground (PE). Refer to local regulations and/or electrical codes for selecting grounding wire gauge. Connect the inverter grounding connections to a ground bus bar, to a single ground point, or to a common grounding point (impedance $\leq 10 \Omega$). To comply with IEC 61800-5-1 standard, connect the inverter to the ground by using a single conductor copper cable with a minimum wire gauge of 10 mm², since the leakage current is greater than 3.5 mAac.

ATTENTION!

The neutral conductor of the mains supply must be solidly grounded. However, this conductor must not be used to ground the inverter.

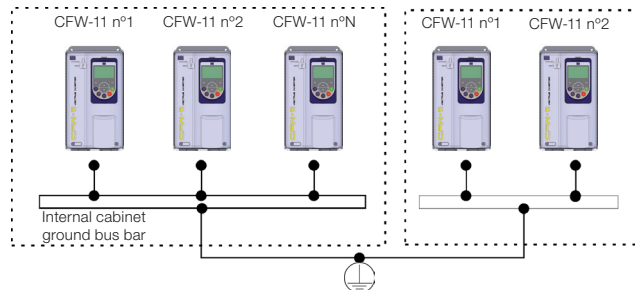

Figure 20: Grounding connections with multiple inverters

CONTROL CONNECTIONS

The control connections (analog inputs/outputs, digital inputs/outputs), must be made at the CC11 control board terminal strip XC1.

	XC1 Terminal Strip	Factory Setting Function
	1	REF+
	2	AI1+
	3	AI1-
	4	REF-
	5	AI2+
	6	AI2-
	7	AO1
	8	AGND (24 V)
	9	AO2
	10	AGND (24 V)
	11	DGND*
	12	COM
	13	24 Vdc
	14	COM
	15	DI1
	16	DI2
	17	DI3
	18	DI4
	19	DI5
	20	DI6
	21	NC1
	22	C1
	23	NO1
	24	NC2
	25	C2
	26	NO2
	27	NC3
	28	C3
	29	NO3

Figure 21: Signals at connector XC1 - digital inputs working as "Active High"



NOTE!

For changing to "Active Low" remove the jumpers between XC1:11 and 12, place this jumper between XC1:12 and 13 and connect common points of the switches on DI1 to DI6 to XC1:11, instead of XC1:13.

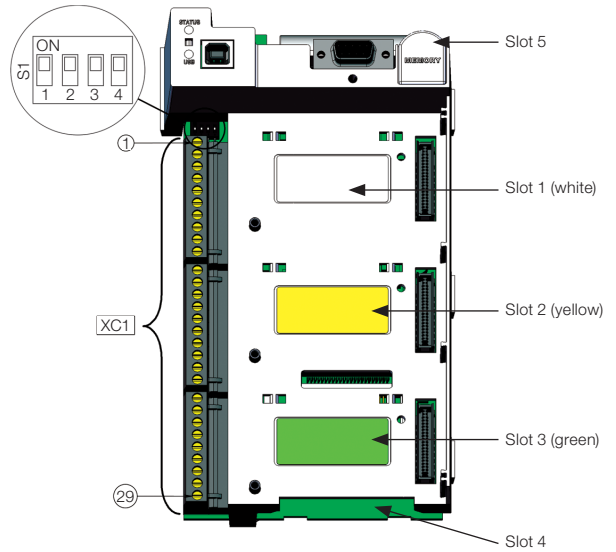

Signal	Factory Default Function	DIP-switch	Selection	Factory Setting
AI1	Speed Reference (remote)	S1.4	OFF: 0 to 10 V (factory setting) ON: 4 to 20 mA / 0 to 20 mA	OFF
AI2	No Function	S1.3	OFF: 0 to ±10 V (factory setting) ON: 4 to 20 mA / 0 to 20 mA	OFF
AO1	Speed	S1.1	OFF: 4 to 20 mA / 0 to 20 mA ON: 0 to 10 V (factory setting)	ON
AO2	Motor Current	S1.2	OFF: 4 to 20 mA / 0 to 20 mA ON: 0 to 10 V (factory setting)	ON

Figure 22: DIP Switches for setting signal type on analog inputs and outputs



NOTE!

For information of Safety Stop (STO) function refer to Installation, Configuration and Operation guide.

Typical Control Connections

Control connection # 1 - Run/Stop function controlled from the keypad (Local Mode).

With this control connection, it is possible to run the inverter in local mode with the factory default settings. This operation mode is recommended for first-time users, since no additional control connections are required.

Control connection # 2 - 2-Wire Run/Stop function (Remote Mode).

This wiring example is valid only for the default factory settings and if the inverter is set to remote mode. With the factory default settings, the selection of the operation mode (local/remote) is performed through the HMI key (local mode is default). Set P0220=3 to change the default setting of HMI key to remote mode.

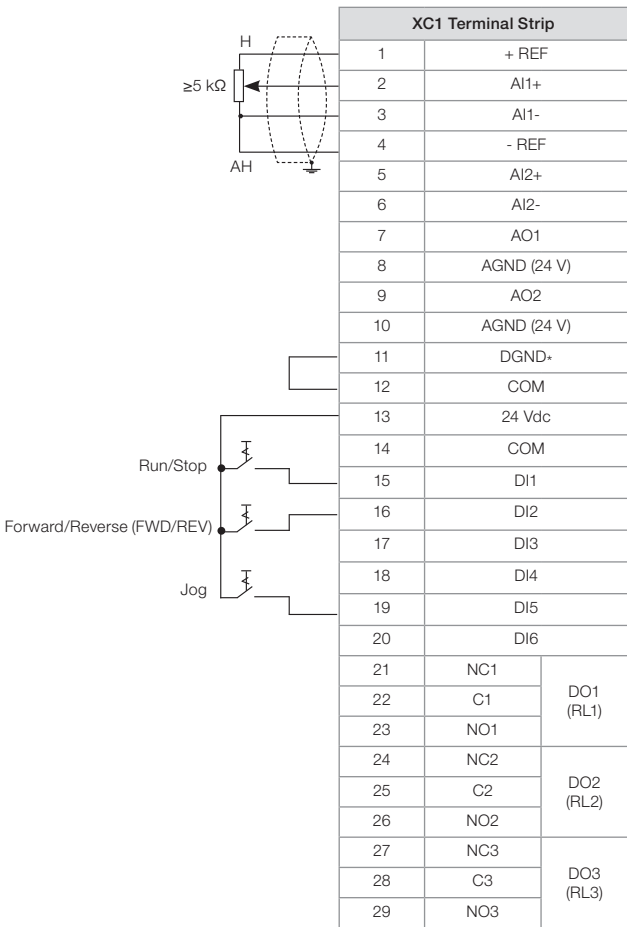

Figure 23: XC1 wiring for control connection # 2

Control connection # 3 - 3-Wire Start/Stop function.

Enabling the Run/Stop function with 3-wire control. Parameters to set: Set DI3 to START: P0265=6 Set DI4 to STOP: P0266=7 Set P0224=1 (DIx) for 3-wire control in Local mode. Set P0227=1 (DIx) for 3-wire control in Remote mode. Set the Forward/Reverse selection by using digital input # 2 (DI2). Set P0223=4 for Local Mode or P0226=4 for Remote Mode. S1 and S2 are Start (NO contact) and Stop (NC contact) pushbuttons respectively. The speed reference can be provided through the analog input (as in control connection # 2), through the keypad (as in control connection # 1) or through other available source.

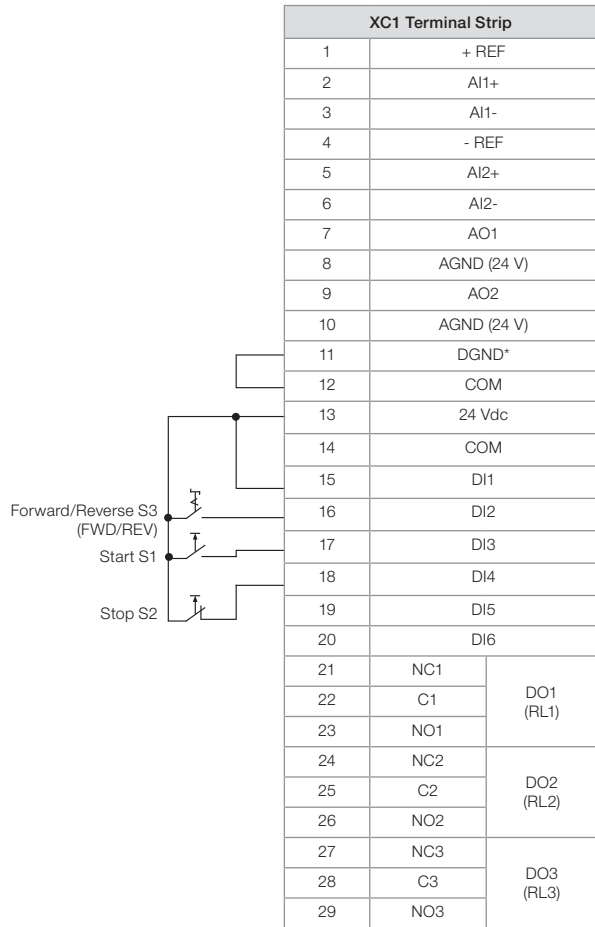

Figure 24: XC1 wiring for control connection # 3



Control connection # 4 - Forward/Reverse.

Enabling the Forward/Reverse function.

Parameters to set:

Set DI3 to Forward run: P0265=4

Set DI4 to Reverse run: P0266=5

When the Forward/Reverse function is set, it will be active either in Local or Remote mode. At the same time, the HMI keys  and  will remain always inactive (even if P0224=0 or P0227=0).

The direction of rotation is determined by the Forward run and Reverse run inputs.

Clockwise direction for Forward run and counterclockwise for Reverse run.

The speed reference can be provided by any source (as in the control connection # 3).

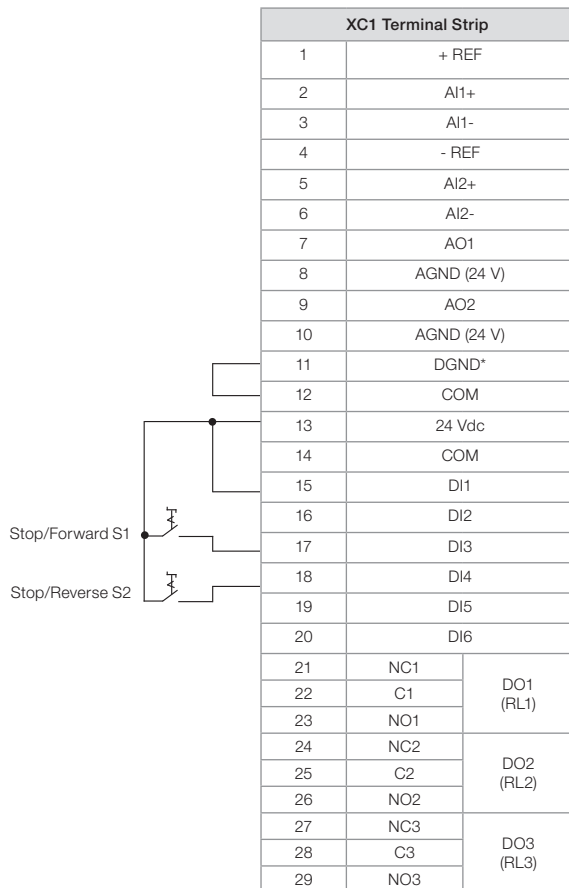

Figure 25: XC1 wiring for control connection # 4

INSTALLATION ACCORDING TO THE EUROPEAN DIRECTIVE OF ELECTROMAGNETIC COMPATIBILITY

The inverters in sizes A to D with FA option (CFW11XXXXXXOFA) and all the standard inverters in the other sizes have an internal RFI filter for the reduction of the electromagnetic interference. These inverters, when properly installed meet the requirements of the electromagnetic compatibility directive "EMC Directive 2004/108/EC".



ATTENTION!

For using models with internal RFI filters in IT networks follow the instructions on figures 17 to 19.

Conformal Installation

For the conformal installation use:

1. Inverters on sizes A to D: with internal RFI filters option CFW11XXXXXXOFA and other standard models.
2. Shielded output cables (motor cables) and connect the shield at both ends (motor and inverter) with a low impedance connection for high frequency.
Maximum motor cable length and conducted and radiated emission levels according to the tables 2 and 3.
If a lower emission level and/or a longer motor cable were necessary, then an external RFI filter must be provided at the inverter input. For more information (RFI filter commercial reference, motor cable length and emission levels) refer to the tables 2 and 3.
3. Shielded control cables.
4. Inverter solid grounding.

Table 2: Conducted and radiated emission levels for sizes A to D

Inverter model (with built-in RFI filter)	Without external RFI filter			With external RFI filter				
	Conducted emission - maximum motor cable length	Radiated emission	External RFI filter part number (manufacturer: EPCOS)	Conducted emission - maximum motor cable length		Radiated emission - category		
				Category C3	Category C2	Without metallic cabinet	Inside a metallic cabinet	
CFW11 0006 S 2 O FA	100 m (328.10 ft)	7 m (23.00 ft)	C2	B84142-A16-R122	75 m (246.06 ft)	50 m (164.04 ft)	C2	C2
				B84142-B16-R	100 m (328.10 ft)	100 m (328.10 ft)		
CFW11 0007 T 2 O FA	100 m (328.10 ft)	5 m (16.40 ft)	C2	B84143-G8-R110	100 m (328.10 ft)	-	C2	C2
				B84143-A8-R105	50 m (164.04 ft)	50 m (164.04 ft)		
CFW11 0007 S 2 O FA	100 m (328.10 ft)	7 m (23.00 ft)	C2	B84142-A16-R122	75 m (246.06 ft)	50 m (164.04 ft)	C2	C2
				B84142-B16-R	100 m (328.10 ft)	100 m (328.10 ft)		
CFW11 0010 S 2 O FA	100 m (328.10 ft)	7 m (23.00 ft)	C2	B84142-A30-R122	75 m (246.06 ft)	50 m (164.04 ft)	C2	C2
				B84142-B25-R	100 m (328.10 ft)	100 m (328.10 ft)		
CFW11 0010 T 2 O FA	100 m (328.10 ft)	5 m (16.40 ft)	C2	B84143-G20-R110	100 m (328.10 ft)	-	C2	C2
				B84143-A16-R105	50 m (164.04 ft)	50 m (164.04 ft)		
CFW11 0013 T 2 O FA	100 m (328.10 ft)	5 m (16.40 ft)	C2	B84143-G20-R110	100 m (328.10 ft)	-	C2	C2
				B84143-A16-R105	50 m (164.04 ft)	50 m (164.04 ft)		
CFW11 0016 T 2 O FA	100 m (328.10 ft)	5 m (16.40 ft)	C2	B84143-G20-R110	100 m (328.10 ft)	-	C2	C2
				B84143-A25-R105	50 m (164.04 ft)	50 m (164.04 ft)		
CFW11 0024 T 2 O FA	100 m (328.10 ft)	No	C2	B84143-A36-R105	100 m (328.10 ft)	100 m (328.10 ft)	C2	C2
CFW11 0028 T 2 O FA	100 m (328.10 ft)	No	C2	B84143-A36-R105	100 m (328.10 ft)	100 m (328.10 ft)	C2	C2
CFW11 0033 T 2 O FA	100 m (328.10 ft)	No	C2	B84143-A50-R105	100 m (328.10 ft)	100 m (328.10 ft)	C2	C2
CFW11 0045 T 2 O FA	100 m (328.10 ft)	No	C3	B84143-A50-R105	100 m (328.10 ft)	100 m (328.10 ft)	C3	C2
CFW11 0054 T 2 O FA	100 m (328.10 ft)	No	C3	B84143-A66-R105	100 m (328.10 ft)	100 m (328.10 ft)	C3	C2
CFW11 0070 T 2 O FA	100 m (328.10 ft)	No	C3	B84143-A90-R105	100 m (328.10 ft)	100 m (328.10 ft)	C3	C2
CFW11 0086 T 2 O FA	100 m (328.10 ft)	No	C3	B84143-A120-R105	100 m (328.10 ft)	100 m (328.10 ft)	C3	C2
CFW11 0105 T 2 O FA	100 m (328.10 ft)	No	C3	B84143-A120-R105	100 m (328.10 ft)	100 m (328.10 ft)	C3	C2
CFW11 0003 T 4 O FA	100 m (328.10 ft)	5 m (16.40 ft)	C2	B84143-G8-R110	100 m (328.10 ft)	-	C2	C2
				B84143-A8-R105	50 m (164.04 ft)	50 m (164.04 ft)		
CFW11 0005 T 4 O FA	100 m (328.10 ft)	5 m (16.40 ft)	C2	B84143-G8-R110	100 m (328.10 ft)	-	C2	C2
				B84143-A8-R105	50 m (164.04 ft)	50 m (164.04 ft)		
CFW11 0007 T 4 O FA	100 m (328.10 ft)	5 m (16.40 ft)	C2	B84143-G8-R110	100 m (328.10 ft)	-	C2	C2
				B84143-A8-R105	50 m (164.04 ft)	50 m (164.04 ft)		
CFW11 0010 T 4 O FA	100 m (328.10 ft)	5 m (16.40 ft)	C2	B84143-G20-R110	100 m (328.10 ft)	-	C2	C2
				B84143-A16-R105	50 m (164.04 ft)	50 m (164.04 ft)		
CFW11 0013 T 4 O FA	100 m (328.10 ft)	5 m (16.40 ft)	C2	B84143-G20-R110	100 m (328.10 ft)	-	C2	C2
				B84143-A16-R105	50 m (164.04 ft)	50 m (164.04 ft)		
CFW11 0017 T 4 O FA	100 m (328.10 ft)	No	C2	B84143-A25-R105	100 m (328.10 ft)	100 m (328.10 ft)	C2	C2
CFW11 0024 T 4 O FA	100 m (328.10 ft)	No	C2	B84143-A36-R105	100 m (328.10 ft)	100 m (328.10 ft)	C2	C2
CFW11 0031 T 4 O FA	100 m (328.10 ft)	No	C2	B84143-A36-R105	100 m (328.10 ft)	100 m (328.10 ft)	C2	C2
CFW11 0038 T 4 O FA	100 m (328.10 ft)	No	C3	B84143-A50-R105	100 m (328.10 ft)	100 m (328.10 ft)	C3	C2
CFW11 0045 T 4 O FA	100 m (328.10 ft)	No	C3	B84143-A50-R105	100 m (328.10 ft)	100 m (328.10 ft)	C3	C2
CFW11 0058 T 4 O FA	100 m (328.10 ft)	No	C3	B84143-A66-R105	100 m (328.10 ft)	100 m (328.10 ft)	C3	C2
CFW11 0070 T 4 O FA	100 m (328.10 ft)	No	C3	B84143-A90-R105	100 m (328.10 ft)	100 m (328.10 ft)	C3	C2
CFW11 0088 T 4 O FA	100 m (328.10 ft)	No	C3	B84143-A120-R105	100 m (328.10 ft)	100 m (328.10 ft)	C3	C2

Table 3: Conducted and radiated emission levels for sizes E to G

Inverter model (built-in RFI filter)	Frame	Without external RFI filter		With external RFI filter			
		Conducted emission - maximum motor cable length	Radiated emission	External RFI filter part number - (manufacturer: EPCOS)	Conducted emission - maximum motor cable length	Radiated emission - without metallic cabinet	Radiated emission - with metallic cabinet
CFW11 0142 T2		100 m (328.10 ft)	C2	B84143-B0150-S020	100 m (328.10 ft)	C2	
CFW11 0180 T2		100 m (328.10 ft)	C2	B84143-B0180-S020 (1)	100 m (328.10 ft)	C2	
CFW11 0211 T2		100 m (328.10 ft)	C2	B84143-B0250-S020 (2)	100 m (328.10 ft)	C2	
CFW11 0105 T4	E	100 m (328.10 ft)	C2	B84143-B0150-S020	100 m (328.10 ft)	C2	
CFW11 0142 T4		100 m (328.10 ft)	C2	B84143-B0150-S020	100 m (328.10 ft)	C2	
CFW11 0180 T4		100 m (328.10 ft)	C2	B84143-B0180-S020 (1)	100 m (328.10 ft)	C2	
CFW11 0211 T4		100 m (328.10 ft)	C2	B84143-B0250-S020 (2)	100 m (328.10 ft)	C2	
CFW11 0242 T4		100 m (328.10 ft)	C3 (3)	B84143-B0250-S021	100 m (328.10 ft) (4)	C3	
CFW11 0312 T4		100 m (328.10 ft)	C3 (3)	B84143-B01420-S021	100 m (328.10 ft) (4)	C3	
CFW11 0370 T4	F	100 m (328.10 ft)	C3 (3)	B84143-B0400-S021	100 m (328.10 ft) (4)	C3	
CFW11 0477 T4		100 m (328.10 ft)	C3 (3)	B84143-B0600-S021	100 m (328.10 ft) (4)	C3	
CFW11 0515 T4		100 m (328.10 ft)	C3 (3)	B84143-B0600-S021	100 m (328.10 ft) (4)	C3	
CFW11 0601 T4	G	100 m (328.10 ft)	C3 (3)	B84143-B0600-S021	100 m (328.10 ft) (4)	C3	
CFW11 0720 T4		100 m (328.10 ft)	C3 (3)	B84143-B1000-S021	100 m (328.10 ft) (4)	C3	

Notes for table 3:

- (1) For inverter/filter surrounding air temperature higher than 40 °C (104 °F) and continuous output current higher than 172 Arms, it's required to use B84143B0250S020 filter.
- (2) For inverter/filter surrounding air temperature of 40 °C (104 °F) and HD applications (heavy duty cycle, output current < 180 Arms), it's possible to use B84143B0180S020 filter.
- (3) With a toroidal core in the three mains cable. Example: TDK PN: PC40 UU120x160x20.
- (4) 2.5 Hz minimum operating frequency.

INTEGRAL KEYPAD - HMI-CFW11

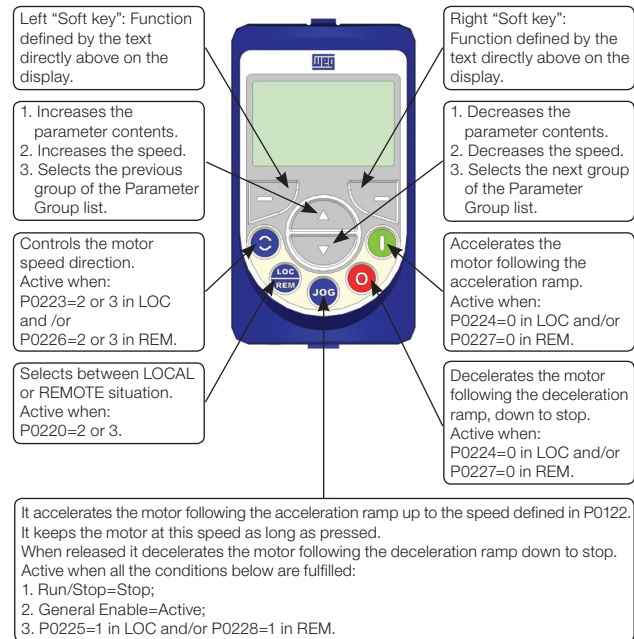

Figure 26: Keypad keys and functions

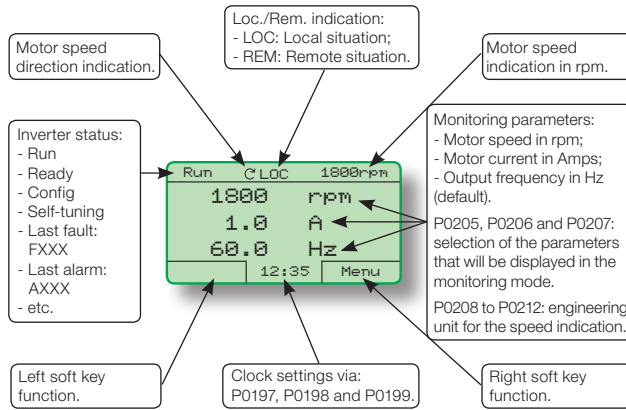

Figure 27: Keypad display and factory default functions example (monitoring mode)



Figure 28: Keypad battery cover to access battery

Notes on Keypad:

- Hot pluggable.
- Other monitoring screen types can be programmed, as bar graphs and larger font sizes, through P0205-207, P0208-212 adjustments.
- The battery is used only to keep the internal clock operation when the inverter stays without power. If the battery is completely discharged or if it is not installed in the keypad, the displayed clock time will be invalid and an alarm condition "A181 - Invalid clock time" will be indicated every time the inverter is powered up.
- At the end of the battery useful life, please do not discard batteries in your waste container, but use an appropriate battery disposal site.

PARAMETER STRUCTURE

When the right soft key ("MENU") is pressed in the monitoring mode, the display shows the first groups of parameters. The number and name of the groups may change depending on the firmware version used.

START-UP

DANGER!
The inverter will be damaged in case the input power supply is connected to the output terminals.

BEFORE ENERGIZING

- Check if power, grounding, and control connections are correct and firmly secured.
- Remove from inside the inverter or the cabinet all the materials left behind from the installation work.
- Verify the motor connections and if its voltage and current are within the inverter rated values.
- Mechanically uncouple the motor from the load. If the motor cannot be uncoupled, make sure that any speed direction (forward or reverse) will not result in personnel injury and/or equipment damage.
- Close the inverter or cabinet covers.
- Measure the power supply voltage and verify if it is within the allowed range.
- Apply power to the input, closing the input disconnect switch.
- Check the result of the first time start-up:
The keypad should display the standard monitoring mode and the status LED should be steady green.

STARTING UP IN V/F MODE

The start-up procedure for the V/f is described in three simple steps by using the **Oriented Start-up** routine and the **Basic Application** group.

1) P0000 Password Setting

Step	Action/Result	Display Indication
1	- Monitoring Mode. - Press "Menu" (right soft key).	Ready C LOC 0rpm 0 rpm 0.0 A 0.0 Hz 15:45 Menu
2	- The group "00 ALL PARAMETERS" is already selected. - Press "Select".	Ready C LOC 0rpm 00 ALL PARAMETERS 01 PARAMETER GROUPS 02 ORIENTED START-UP 03 CHANGED PARAMETERS Return 15:45 Select
3	- The parameter "Access to Parameters P0000: 0" is already selected. - Press "Select".	Ready C LOC 0rpm Access to Parameters P0000: 0 Speed Reference P0001: 90 rpm Return 15:45 Select
4	- In order to set the password, press until the number 5 appears on the display.	Ready C LOC 0rpm P0000 Access to Parameters 0 Return 15:45 Save
5	- When the number 5 appears, press "Save".	Ready C LOC 0rpm P0000 Access to Parameters 5 Return 15:45 Save
6	- If the setting was performed correctly, the display must show "Access to Parameters P0000: 5". - Press "Return" (left soft key).	Ready C LOC 0rpm Access to Parameters P0000: 5 Speed Reference P0001: 90 rpm Return 15:45 Select
7	- Press "Return".	Ready C LOC 0rpm 00 ALL PARAMETERS 01 PARAMETER GROUPS 02 ORIENTED START-UP 03 CHANGED PARAMETERS Return 15:45 Select
8	- The display returns to the Monitoring Mode.	Ready C LOC 0rpm 0 rpm 0.0 A 0.0 Hz 15:45 Menu

Figure 29: Steps for allowing parameter modification via P0000

2) Oriented Start-Up

There is a group of parameters named "Oriented Start-up", which makes the inverter settings easier. The parameter P0317 from this group allows entering the Oriented Start-up routine.

The Oriented Start-Up routine presents the main parameters on the HMI in a logical sequence. The minimum necessary parameters for proper operation are adjusted. Information like mains voltage and motor nameplate data is entered.

In order to enter into the Oriented Start-up routine, first change parameter P0317 to 1 and then, set all remaining parameters as they are presented on the display.

Setting the parameters in the Oriented Start-up routine causes the automatic content modification of the other parameters and/or internal inverter variables.

During the Oriented Start-up routine, the message "Config" will be displayed at the top left corner of the HMI display.

3) Basic Application Parameter Settings

After running the Oriented Start-up routine and properly setting the parameters, the inverter is ready to operate in V/f mode.

The group Basic Application has the more common application parameters.

DATE AND TIME SETTING

Access the group HMI and change: day (P0194), month (P0195) and year (P0196); time: hour (P0197), minutes (P0198) and seconds (P0199).

PARAMETER CHANGE PREVENTION

To prevent unauthorized or unintended parameter modifications, the parameter P0000 can be set to a value different from 5.

FLASH MEMORY MODULE FUNCTIONS

- Store a copy of the inverter parameters.
- Transfer parameters stored in the FLASH memory to the inverter.
- Transfer firmware stored in the FLASH memory to the inverter.
- Store the program created with SoftPLC.

Whenever the inverter is powered up, this program (SoftPLC) is transferred to the RAM memory located in the inverter control board and executed.

Refer to the CFW-11 programming manual and to SoftPLC manual for further details.

APPENDIX 1 – TECHNICAL SPECIFICATIONS
Table A.1: Technical specifications of the sizes A to D

Model	Frame	Number of power phases	Use with Normal Duty (ND) cycle						Use with Heavy Duty (HD) cycle						Fuse [A] according to the IEC European Standard	Fuse I²t [A²s] @ 25 °C	Surrounding air temperature [°C (°F)]	Dynamic braking	Availability of option kits that can be incorporated into the product					
			Rated output current [Arms]	Overload current [Arms]	Rated carrier frequency [kHz]	Maximum motor [HP/kW]	Rated input current [Arms]	Dissipated power [W]	Rated output current [Arms]	Overload current [Arms]	Rated carrier frequency [kHz]	Maximum motor [HP/kW]	Rated input current [Arms]	Dissipated power [W]						Rated output current [Arms]	Overload current [Arms]	Rated carrier frequency [kHz]	Maximum motor [HP/kW]	Rated input current [Arms]
CFW11 0006 B 2	A	1ø/3ø	6	6.6	9	5	1.5/1.1	12.3/6	130	25	5	7.5	10	5	1.5/1.1	10.3/5	120	25	420	Nema 1 (conduit kit for frame A)	Yes	Yes	Yes	Yes
CFW11 0006 S 2 O FA		1ø	6	6.6	9	5	1.5/1.1	12.3	130	25	5	7.5	10	5	1.5/1.1	10.3	120	25	420					
CFW11 0007 T 2	A	3ø	7	7.7	10.5	5	2/1.5	7	140	25	5.5	8.25	11	5	1.5/1.1	5.5	120	25	420	Nema 1 (conduit kit for frame A)	Yes	Yes	Yes	Yes
CFW11 0007 B 2		1ø/3ø	7	7.7	10.5	5	2/1.5	14.4/7	140	25	7	10.5	14	5	2/1.5	14.4/7	140	25	420					
CFW11 0007 S 2 O FA	A	1ø	7	7.7	10.5	5	2/1.5	14.4	140	25	7	10.5	14	5	2/1.5	14.4	140	25	420	Nema 1 (conduit kit for frame B)	Yes	Yes	Yes	Yes
CFW11 0010 T 2		3ø	10	11	15	5	3/2.2	10	170	30	8	12	16	5	2/1.5	8	170	30	1000					
CFW11 0010 S 2	A	1ø	10	11	15	5	3/2.2	20.5	180	30	10	15	20	5	3/2.2	20.5	140	25	1000	Nema 1 (conduit kit for frame C)	Yes	Yes	Yes	Yes
CFW11 0013 T 2		3ø	13	14.3	19.5	5	4/3.0	13	200	30	11	16.5	22	5	3/2.2	11	170	30	2500					
CFW11 0016 T 2	A	3ø	16	17.6	24	5	5/3.7	16	230	30	13	19.5	26	5	4/3.0	13	190	30	420	Nema 1 (conduit kit for frame D)	Yes	Yes	Yes	Yes
CFW11 0024 T 2		3ø	24	26.4	36	5	7.5/5.5	24	310	50	20	30	40	5	6/4.5	20	250	40	1000					
CFW11 0028 T 2	B	3ø	28	30.8	42	5	10/7.5	28	370	60	24	36	48	5	7.5/5.5	24	290	40	1000	Nema 1 (conduit kit for frame D)	Yes	Yes	Yes	Yes
CFW11 0033 T 2		3ø	33.5	36.9	50.3	5	12.5/9.2	33.5	430	60	28	42	56	5	12.5/9.2	36	450	70	2750					
CFW11 0045 T 2	C	3ø	45	49.5	67.5	5	15/11	45	590	90	36	54	72	5	15/11	45	540	80	2750	Nema 1 (conduit kit for frame C)	Yes	Yes	Yes	Yes
CFW11 0054 T 2		3ø	54	59.4	81	5	20/15	54	680	100	45	67.5	90	5	20/15	56	680	100	2750					
CFW11 0070 T 2	D	3ø	70	77	105	5	25/18.5	70	900	140	56	84	112	5	30/22	86	920	140	3150	Nema 1 (conduit kit for frame D)	Yes	Yes	Yes	Yes
CFW11 0088 T 2		3ø	86	94.6	129	5	30/22	86	970	150	70	105	140	5	30/22	86	920	140	3150					
CFW11 0105 T 2	D	3ø	105	116	158	5	40/30	105	1200	180	86	129	172	5	30/22	86	920	140	3150	Nema 1 (conduit kit for frame D)	Yes	Yes	Yes	Yes
CFW11 0003 T 4		3ø	3.6	3.96	5.40	5	2/1.5	3.6	130	25	3.6	5.4	7.2	5	2/1.5	3.6	110	25	190					
CFW11 0005 T 4	A	3ø	5	5.5	7.5	5	3/2.2	5	140	25	5	7.5	10	5	3/2.2	5	140	25	190	Nema 1 (conduit kit for frame A)	Yes	Yes	Yes	Yes
CFW11 0007 T 4		3ø	7	7.7	10.5	5	4/3	7	180	30	5.5	8.25	11	5	3/2.2	5.5	140	25	190					
CFW11 0010 T 4	A	3ø	10	11	15	5	6/4.5	10	220	30	10	15	20	5	6/4.5	10	200	30	495	Nema 1 (conduit kit for frame B)	Yes	Yes	Yes	Yes
CFW11 0013 T 4		3ø	13.5	14.9	20.3	5	7.5/5.5	13.5	280	40	11	16.5	22	5	7.5/5.5	13.5	270	40	495					
CFW11 0017 T 4	B	3ø	17	18.7	25.5	5	10/7.5	17	360	50	13.5	20.3	27	5	10/7.5	19	360	50	500	Nema 1 (conduit kit for frame C)	Yes	Yes	Yes	Yes
CFW11 0024 T 4		3ø	24	26.4	36	5	15/11	24	490	70	19	28.5	38	5	15/11	25	430	60	1250					
CFW11 0031 T 4	C	3ø	31	34.1	46.5	5	20/15	31	560	80	25	37.5	50	5	20/15	33	590	90	1250	Nema 1 (conduit kit for frame D)	Yes	Yes	Yes	Yes
CFW11 0038 T 4		3ø	38	41.8	57	5	25/18.5	38	710	110	33	49.5	66	5	25/18.5	38	650	100	2100					
CFW11 0045 T 4	C	3ø	45	49.5	67.5	5	30/22	45	810	120	38	57	76	5	30/22	47	800	120	2100	Nema 1 (conduit kit for frame C)	Yes	Yes	Yes	Yes
CFW11 0058 T 4		3ø	58.5	64.4	87.8	5	40/30	58.5	1050	160	47	70.5	94	5	40/30	61	1050	160	2100					
CFW11 0070 T 4	D	3ø	70.5	77.6	106	5	50/37	70.5	1280	190	61	91.5	122	5	50/37	80	1170	180	3150	Nema 1 (conduit kit for frame D)	Yes	Yes	Yes	Yes
CFW11 0088 T 4		3ø	88	96.8	132	5	60/4.5	88	1480	220	73	110	146	5	60/37	73	1170	180	3150					

Models with 200... 240 V power supply

Models with 380... 480 V power supply

Table A.2: Technical specifications of the sizes E to G

Model	Frame	Number of power phases	Use with Normal Duty (ND) cycle							Use with Heavy Duty (HD) cycle							Fuse [A] according to the IEC European Standard	Fuse I ^{2t} [A ^{2s}] @ 25 °C	Surrounding air temperature [°C (°F)]	Dynamic braking	Availability of option kits that can be incorporated into the product				
			Rated output current ⁽¹⁾ [Arms]	Overload current ⁽²⁾ [Arms]	Rated carrier frequency [kHz]	Maximum motor [HP/kW]	Rated input current [Arms]	Disipated power [W]	Surface mounting	Flange mounting	Rated output current ⁽¹⁾ [Arms]	Overload current ⁽²⁾ [Arms]	Rated carrier frequency [kHz]	Maximum motor [HP/kW]	Rated input current [Arms]	Disipated power [W]						Surface mounting	Flange mounting	Weight [kg (lb)]	
CFW11 0142 T 2		3ø	142	156.2	213	2.5	50/37	142	1490	210	115	172.5	230	5	40/30	115	1280	200	64.0 (141.1)	200	39200	-10...45 (14...113)	Optional (the standard product does not have dynamic braking)	Nema 1 (kit KNIE-01)	24 Vdc external control power supply
CFW11 0180 T 2		3ø	180	198	270	2.5	60/45	180	1820	360	142	213	284	5	50/37	142	1550	350	65.0 (143.3)	200	218000	-10...45 (14...113)	Optional (the standard product does not have dynamic braking)	Nema 1 (kit KNIE-02)	Safety stop
CFW11 0211 T 2		3ø	211	232	317	2.5	75/55	211	2040	360	180	270	360	2.5	75/55	180	1690	350	65.0 (143.3)	250	218000	-10...45 (14...113)	Optional (the standard product does not have dynamic braking)	Nema 1 (kit KNIE-01)	RFI filter
CFW11 0105 T 4	E	3ø	105	115.5	157.5	2.5	75/55	105	1270	200	88	132	176	2.5	60/45	88	1020	190	62.5 (137.8)	125	39200	-10...45 (14...113)	Optional (the standard product does not have dynamic braking)	Nema 1 (kit KNIE-02)	Built-in
CFW11 0142 T 4		3ø	142	156.2	213	2.5	100/75	142	1680	210	115	172.5	230	2.5	75/55	115	1290	200	64.0 (141.1)	200	39200	-10...45 (14...113)	Optional (the standard product does not have dynamic braking)	Nema 1 (kit KNIE-01)	Built-in
CFW11 0180 T 4		3ø	180	198	270	2.5	150/110	180	2050	360	142	213	284	2.5	100/75	142	1570	350	65.0 (143.3)	200	218000	-10...45 (14...113)	Optional (the standard product does not have dynamic braking)	Nema 1 (kit KNIE-02)	Yes
CFW11 0211 T 4		3ø	211	232.1	317	2.5	175/132	211	2330	360	180	270	360	2.5	150/110	180	1940	350	65.0 (143.3)	250	218000	-10...45 (14...113)	Optional (the standard product does not have dynamic braking)	Nema 1 (kit KNIE-01)	Yes
CFW11 0242 T 4		3ø	242	266	363	2.5	200/150	242	1518	285	211	317	422	2.5	175/132	211	1277	227	130 (286.6)	315	320000	-10...45 (14...113)	Optional (the standard product does not have dynamic braking)	IP20	Yes
CFW11 0312 T 4		3ø	312	343	468	2.5	250/185	312	2034	375	242	363	484	2.5	200/150	242	1507	292	132 (291.0)	500	414000	-10...45 (14...113)	Optional (the standard product does not have dynamic braking)	IP20	Yes
CFW11 0370 T 4	F	3ø	370	407	555	2.5	300/220	370	2497	407	312	468	624	2.5	250/185	312	2008	320	135 (297.6)	500	414000	-10...45 (14...113)	Optional (the standard product does not have dynamic braking)	IP20	Yes
CFW11 0477 T 4		3ø	477	525	716	2.5	400/300	477	3273	595	370	555	740	2.5	300/220	370	2451	465	140 (308.6)	700	1051000	-10...45 (14...113)	Optional (the standard product does not have dynamic braking)	IP20	Yes
CFW11 0515 T 4		3ø	515	567	773	2	400/300	515	3338	769	477	716	954	2	400/300	477	2987	644	204 (449.7)	900	1445000	-10...45 (14...113)	Optional (the standard product does not have dynamic braking)	IP20	Yes
CFW11 0601 T 4	G	3ø	601	662	900	2	500/370	601	3875	781	515	773	1030	2	400/300	515	3219	639	207 (456.4)	900	1445000	-10...45 (14...113)	Optional (the standard product does not have dynamic braking)	IP20	Yes
CFW11 0720 T 4		3ø	720	792	1080	2	600/440	720	4576	858	560	840	1120	2	450/330	560	3747	653	215 (474.0)	1100	1445000	-10...40 (14...104)	Optional (the standard product does not have dynamic braking)	IP20	Yes

Models with 380... 440 V power supply

Notes:
 (1) Steady state rated current in the following conditions:
 - Specified switching frequencies;
 - Surrounding air temperature as specified in the tables. For higher temperatures, limited to 10 °C (50 °F) above the maximum temperature specified for rated conditions, the output current must be derated by 2 % for each °C above the maximum specified temperature.

(2) The motor power ratings are merely a guide for 230 V or 460 V, IV pole WEG motors. The adequate inverter sizing must be based on the used motor rated current.
 - Relative air humidity: 5 % to 90 % non-condensing.
 - Altitude: 1000 m (3300 ft). Above 1000 m (3300 ft) up to 4000 m (13200 ft) the output current must be derated by 1 % for each 100 m (328.10 ft) above 1000 m (3300 ft).
 - Ambient with pollution degree 2 (according to EN50178 and UL508C).

Table A.3: Dynamic braking specifications for sizes A to E

Inverter model	Maximum braking current (I_{max}) [A]	Maximum braking power (peak value) (P_{max}) ⁽²⁾ [kW]	Effective braking current ($I_{effective}$) ⁽¹⁾ [A]	Dissipated power (mean value) in the braking resistor (P_R) ⁽²⁾ [kW]	Recommended resistor [Ω]	Power wire size (terminals DC+ and BR) [mm ² (AWG)]
CFW11 0006 B 2	5.3	2.1	5.2	2.03	75	1.5 (16)
CFW11 0006 S 2 O FA	5.3	2.1	5.2	2.03	75	1.5 (16)
CFW11 0007 B 2	7.1	2.9	6.96	2.71	56	1.5 (16)
CFW11 0007 S 2 O FA	7.1	2.9	6.96	2.71	56	1.5 (16)
CFW11 0007 T 2	5.3	2.1	5.2	2.03	75	1.5 (16)
CFW11 0010 S 2	11.1	4.4	10.83	4.22	36	2.5 (14)
CFW11 0010 T 2	7.1	2.9	6.96	2.71	56	1.5 (16)
CFW11 0013 T 2	11.1	4.4	8.54	2.62	36	2.5 (14)
CFW11 0016 T 2	14.8	5.9	14.44	5.63	27	4 (12)
CFW11 0024 T 2	26.7	10.7	19.15	5.5	15	6 (10)
CFW11 0028 T 2	26.7	10.7	18.21	4.97	15	6 (10)
CFW11 0033 T 2	26.7	10.7	16.71	4.19	15	6 (10)
CFW11 0045 T 2	44	17.6	33.29	10.1	9.1	10 (8)
CFW11 0054 T 2	48.8	19.5	32.17	8.49	8.2	10 (8)
CFW11 0070 T 2	48.8	19.5	26.13	5.6	8.2	6 (8)
CFW11 0086 T 2	93	37.2	90.67	35.3	4.3	35 (2)
CFW11 0105 T 2	111.1	44.4	90.87	29.7	3.6	35 (2)
CFW11 0003 T 4	3.6	2.9	3.54	2.76	220	1.5 (16)
CFW11 0005 T 4	5.3	4.3	5.2	4.05	150	1.5 (16)
CFW11 0007 T 4	5.3	4.3	5.2	4.05	150	1.5 (16)
CFW11 0010 T 4	8.8	7	8.57	6.68	91	2.5 (14)
CFW11 0013 T 4	10.7	8.5	10.4	8.11	75	2.5 (14)
CFW11 0017 T 4	12.9	10.3	12.58	9.81	62	2.5 (12)
CFW11 0024 T 4	17	13.6	16.59	12.9	47	4 (10)
CFW11 0031 T 4	26.7	21.3	20.49	12.6	30	6 (10)
CFW11 0038 T 4	36.4	29.1	26.06	14.9	22	6 (8)
CFW11 0045 T 4	47.1	37.6	40	27.2	17	10 (8)
CFW11 0058 T 4	53.3	42.7	31.71	15.1	15	10 (8)
CFW11 0070 T 4	66.7	53.3	42.87	22.1	12	10 (6)
CFW11 0088 T 4	87.9	70.3	63.08	36.2	9.1	25 (4)
CFW11 0142 T 2 O DB	266.7	106.7	142	30.2	1.5	70 (2/0) or 2x 25 (2x 4)
CFW11 0180 T 2 O DB	266.7	106.7	180	48.6	1.5	120 (4/0) or 2x 35 (2x 2)
CFW11 0211 T 2 O DB	333.3	133.3	211	53.4	1.2	150 (300) or 2x 50 (2x 1)
CFW11 0105 T 4 O DB	186	148.8	105	47.4	4.3	50 (1)
CFW11 0142 T 4 O DB	266.7	213.3	142	60.5	3	70 (2/0) or 2x 25 (2x 4)
CFW11 0180 T 4 O DB	266.7	213.3	180	97.2	3	120 (4/0) or 2x 35 (2x 2)
CFW11 0211 T 4 O DB	363.6	290.9	191.7	80.8	2.2	120 (250) or 2x 50 (2x 1)

Notes:

(1) The effective braking current presented is just an indicative value, because it depends on the braking duty cycle. The effective braking current can be obtained from the equation below, where t_{br} is given in minutes and corresponds to the sum of all braking times during the most severe cycle of 5 (five) minutes.

$$I_{effective} = I_{max} \cdot \sqrt{\frac{t_{br}}{5}}$$

(2) The P_{max} and P_R values (maximum and mean power of the braking resistor respectively) presented are valid for the recommended resistors and for the effective braking currents presented in the table. The resistor power must be changed according to the braking duty cycle.



Convertidor de Frecuencia

Guía de Instalación

Série: CFW-11

Idioma: Español

Documento: 10001803811 / 00

Fecha de Publicación: 01/2013

ESPAÑOL

PORTUGUÊS

DEUTSCH

FRANÇAIS

РУССКИЙ

NEDERLANDS

ITALIANO

ÍNDICE

SOBRE LA GUÍA.....	27
INSTRUCCIONES DE SEGURIDAD.....	27
DESCRIPCIÓN PRINCIPAL DEL CFW-11.....	27
RECEPCIÓN Y ALMACENAMIENTO.....	27
INSTALACIÓN MECÁNICA.....	27
CONSIDERACIONES GENERALES DE MONTAJE.....	27
MONTAJE EN TABLERO.....	28
INSTALACIÓN ELÉCTRICA.....	30
DIAGRAMAS DE CONEXIÓN.....	30
INFORMACIONES SOBRE CIRCUITOS Y DISPOSITIVOS.....	31
RED IT.....	32
CONEXIONES DE PUESTA A TIERRA.....	32
CONEXIONES DE CONTROL.....	33
INSTALACIONES DE ACUERDO CON LA DIRECTIVA EUROPEA DE COMPATIBILIDAD ELECTROMAGNÉTICA.....	35
INTERFAZ HOMBRE-MÁQUINA- HMI-CFW-11.....	36
ESTRUCTURA DE PARÁMETROS.....	37
START-UP.....	37
ANTES DE LA ENERGIZACIÓN.....	37
ARRANQUE EN EL MODO V/f.....	37
CONFIGURACIÓN DE FECHA Y HORA.....	38
BLOQUEO DE LA MODIFICACIÓN DE LOS PARÁMETROS.....	38
FUNCIONES DEL MÓDULO DE MEMÓRIA FLASH.....	38
APENDICE 1 – ESPECIFICACIONES TÉCNICAS.....	39

SOBRE LA GUÍA

Esta guía presenta como instalar y poner en funcionamiento, en el modo de control V/f, el convertidor de frecuencia CFW-11 de las mecánicas A a G.

Para obtener más detalles sobre el convertidor de frecuencia CFW-11, consulte el manual del usuario y el manual de programación.

También es posible operar el CFW-11 en los modos de control: VVW, Control Vectorial Sensorless y con Encoder para motores de inducción y Control Vectorial Sensorless y con Encoder para motores de imán permanente (PM). Consulte el manual de programación.

Para obtener los manuales en formato electrónico, así como informaciones sobre otras funciones, accesorios y condiciones de funcionamiento, consulte el sitio web de WEG – www.weg.net.

INSTRUCCIONES DE SEGURIDAD

Lea totalmente esta guía antes de instalar u operar el convertidor.

Solamente personas con calificación adecuada y familiaridad con el convertidor CFW-11 y equipamientos asociados deben planear o implementar la instalación, arranque, operación y mantenimiento de este equipamiento. Estas personas deben seguir todas las instrucciones de seguridad contenidas en este manual y/o definidas por normas locales.



¡PELIGRO!

Los procedimientos recomendados en este aviso tienen como objetivo proteger al usuario contra muerte, herimientos graves y daños materiales considerables.

Siempre desconecte la alimentación general antes de tocar cualquier componente eléctrico asociado al convertidor.

Muchos componentes pueden permanecer cargados con altas tensiones y/o en movimiento (ventiladores), incluso después de que la entrada de alimentación CA sea desconectada o apagada. Espere por lo menos 10 minutos para garantizar la total descarga de los condensadores.

Siempre conecte la carcasa del equipamiento a tierra de protección (PE) en el punto adecuado para eso.



¡NOTA!

A los efectos de este manual, se define como personas calificadas a aquellas personas entrenadas que estén aptas para:

1. Instalar, poner a tierra, energizar y operar el CFW-11 de acuerdo con este manual y los procedimientos legales de seguridad vigentes.
2. Utilizar los equipamientos de protección de acuerdo con las normas establecidas.
3. Prestar servicios de primeros auxilios.



¡NOTA!

Los convertidores de frecuencia pueden interferir en otros equipamientos electrónicos. Siga las instrucciones de instalación para minimizar estos efectos.

DESCRIPCIÓN PRINCIPAL DEL CFW-11

El convertidor de frecuencia CFW-11 es un producto de alta performance con modelos que atienden el rango de potencia de 1 a 600cv (0.75 a 450 kW) en siete mecánicas diferentes y tensión de alimentación de 200 a 480 V. Fue desarrollado para control de velocidad y torque de motores de inducción trifásicos y motores PM (de imanes permanentes). La característica principal de este producto es la tecnología "Vectrue" con los siguientes modos de control: Control Scalar (V/f), VVW, "Control Vectorial Sensorless" y "Control Vectorial con Encoder". Funciones adicionales a destacar: "Optimal Braking" (frenado óptimo), "Self-Tuning" (autoajuste) y "Optimal Flux" (flujo óptimo).

Para más detalles consulte el manual del usuario y el manual de programación del CFW-11.

RECEPCIÓN Y ALMACENAMIENTO

Cuando reciba el producto verifique si:

La etiqueta de identificación del CFW-11 corresponde al modelo comprado. Consulte el modelo y las características técnicas en las [tablas A.1 y A.2](#).

Ocurrieron daños durante el transporte. En caso de ser detectado algún problema, contacte inmediatamente a la transportadora.

Si el CFW-11 no es instalado de inmediato, almacénelo en un lugar limpio y seco (temperatura entre -25 °C y 60 °C) con techo, para evitar la entrada de polvo en el interior del convertidor.

INSTALACIÓN MECÁNICA

CONDICIONES AMBIENTALES

Evitar:

- Exposición directa a rayos solares, lluvia, humedad excesiva o niebla salina.
- Gases o líquidos explosivos o corrosivos.
- Vibración excesiva.
- Polvo, partículas metálicas o aceite suspendido en el aire.
- Condiciones ambientales de acuerdo con las [tablas A.1 y A.2](#).

CONSIDERACIONES GENERALES DE MONTAJE

Consultar el peso del convertidor en las [tablas A.1 y A.2](#).

Instalar el convertidor en la posición vertical en una superficie plana.

Dimensiones externas y posición de los agujeros de fijación conforme la [figura 1](#).

Dejar el mínimo de espacios libres indicados en la [figura 2](#) para permitir la circulación de aire para refrigeración.

Nota:

- Para los modelos de las mecánicas A, B y C no es necesario espaciamiento lateral entre los convertidores, si la tapa superior es removida.

No colocar componentes sensibles al calor encima del convertidor.

MONTAJE EN TABLERO

Montaje en superficie:

Prever agotamiento adecuado, de modo que la temperatura interna del tablero quede dentro del rango permitido para las condiciones de operación del convertidor.

La potencia disipada por el convertidor en la condición nominal, conforme lo especificado en la [tabla A.1](#) y [A.2](#) en la columna "Potencia disipada en watts, montaje en superficie".

En la [tabla 1](#) es presentado el mínimo de espacio necesario para la refrigeración del tablero.

La posición y el diámetro de los agujeros de fijación deben ser de acuerdo con la [figura 1](#).

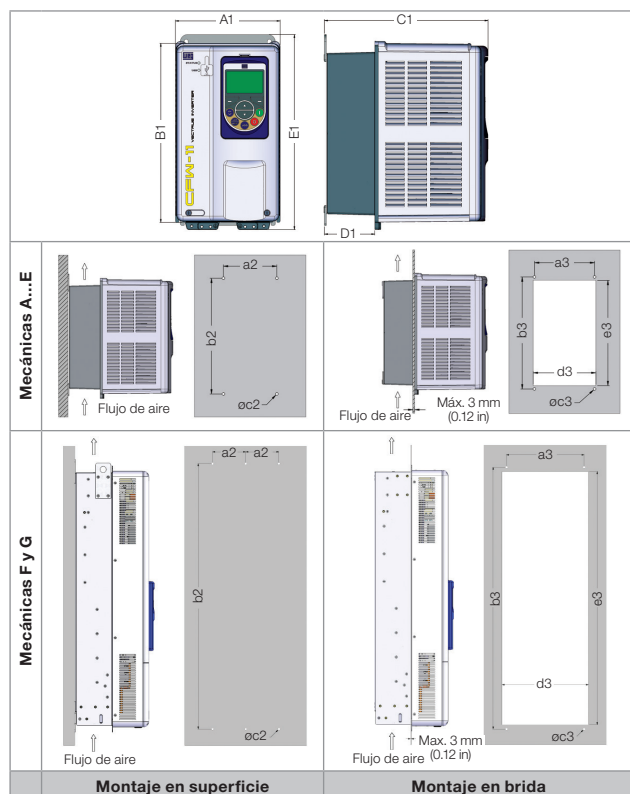

Modelo	A1	B1	C1	D1	E1	a2	b2	c2	a3	b3	c3	d3	e3
	mm (in)	mm (in)	mm (in)	mm (in)	mm (in)	mm (in)	mm (in)	M	mm (in)	mm (in)	M	mm (in)	mm (in)
Mec A	145 (5.71)	247 (9.73)	227 (8.94)	70 (2.75)	270 (10.63)	115 (4.53)	250 (9.85)	M5	130 (5.12)	240 (9.45)	M5	135 (5.32)	225 (8.86)
Mec B	190 (7.48)	293 (11.53)	227 (8.94)	71 (2.78)	316 (12.43)	150 (5.91)	300 (11.82)	M5	175 (6.89)	285 (11.23)	M5	179 (7.05)	271 (10.66)
Mec C	220 (8.67)	378 (14.88)	293 (11.53)	136 (5.36)	405 (15.95)	150 (5.91)	375 (14.77)	M6	195 (7.68)	365 (14.38)	M6	205 (8.08)	345 (13.59)
Mec D	300 (11.81)	504 (19.84)	305 (12.00)	135 (5.32)	550 (21.65)	200 (7.88)	525 (20.67)	M8	275 (10.83)	517 (20.36)	M8	285 (11.23)	485 (19.10)
Mec E	335 (13.19)	620 (24.41)	358 (14.09)	168 (6.61)	675 (25.57)	200 (7.88)	650 (25.59)	M8	275 (10.83)	635 (25.00)	M8	315 (12.40)	615 (24.21)
Mec F	430 (16.93)	1156 (45.51)	360 (14.17)	169 (6.65)	1234 (48.58)	150 (5.91)	1200 (47.24)	M10	350 (13.78)	1185 (46.65)	M10	391 (15.39)	1146 (45.12)
Mec G	535 (21.06)	1190 (46.85)	426 (16.77)	202 (7.95)	1264 (49.76)	200 (7.87)	1225 (48.23)	M10	400 (15.75)	1220 (48.03)	M10	495 (19.49)	1182 (46.53)

Tolerancia de las cotas d3 y e3: ± 1.0 mm (± 0.039 in)
Tolerancias de las demás cotas: ± 1.0 mm (± 0.039 in)

Figura 1: Detalles para la instalación mecánica

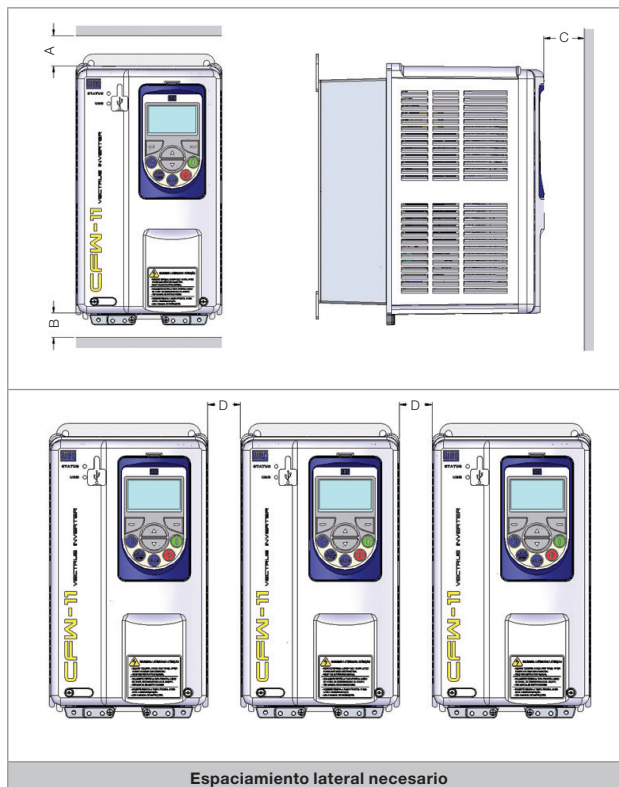

Modelo	A	B	C	D		
	mm(in)	mm(in)	mm(in)	mm(in)		
Mec A	25 (0.98)	25 (0.98)	10 (0.39)	30 (1.18)		
Mec B	40 (1.57)	45 (1.77)				
Mec C	110 (4.33)	130 (5.12)				
Mec D			20 (0.78)	80 (3.15)		
Mec E	0142 T2	100 (3.94)			130 (5.12)	40 (1.57)
	0180 T2	150 (5.91)			250 (9.84)	80 (3.15)
	1211 T2					
	105 T4	100 (3.94)			130 (5.12)	40 (1.57)
	142 T4					
180 T4						
0211 T4	150 (5.91)	250 (9.84)				
Mec F						
Mec G						

Tolerancia: ± 1.0 mm (± 0.039 in)

Figura 2: Espacios libres para ventilación del convertidor

Tabla 1: Flujo de aire de ventilación del tablero

Mecánica	Modelo	CFM	l/s	m³/min
A	Todos	18	8	0.5
B	Todos	42	20	1.2
C	Todos	96	45	2.7
D	Todos	132	62	3.7
E	CFW11 0142 T 2	138	65	3.9
	CFW11 0180 T 2			
	CFW11 0211 T 2	265	125	7.5
	CFW11 0105 T 4	138	65	3.9
	CFW11 0142 T 4	180	95	5.1
	CFW11 0180 T 4			
F	CFW11 0211 T 4	265	125	7.5
	CFW11 0242 T 4	250	118	7.1
	CFW11 0312 T 4	320	151	9.1
	CFW11 0370 T 4	380	180	10.1
G	CFW11 0477 T 4	460	217	13
	CFW11 0515 T 4			
	CFW11 0601 T 4	680	321	19.3

Montaje en brida:

La potencia especificada en las [tablas A.1 y A.2](#) en la columna "Potencia disipada en watts, montaje en brida" será disipada en el interior del tablero. El restante será disipado en el ducto de ventilación.

Los soportes de fijación y las chapas para izamiento del convertidor deberán ser removidos y reposicionados en las mecánicas E, F y G, conforme es presentado en las [figuras 3 y 4](#).

La parte del convertidor que queda hacia fuera del tablero posee grado de protección IP54 para las mecánicas A a E y IP20 para las mecánicas F y G.

Con el propósito de garantizar este grado de protección el tablero debe contemplar aislamiento adecuado en los cortes hechos para el pasaje del disipador del convertidor. Ejemplo: aislamiento con silicona.

Dimensiones del rasgo en la superficie de montaje, posición y diámetro de los agujeros de fijación, conforme la [figura 1](#).



Figura 3: Reposicione los soportes de montaje en las mecánicas A a E. En las mecánicas F y G los soportes deben ser removidos



Figura 4: Instalación de las chapas para izamiento del convertidor de las mecánicas E, F y G

Acceso a los bornes de Control y Potencia

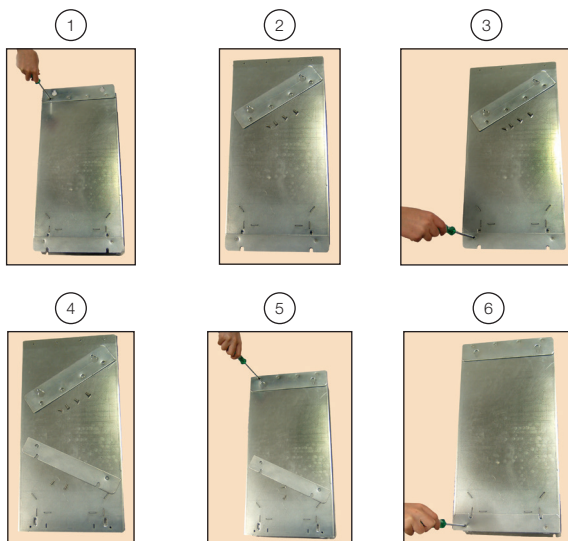
En las mecánicas A, B y C, es necesario retirar la HMI y la tapa frontal para acceder a los bornes de control y de potencia. Conforme la figura a seguir.

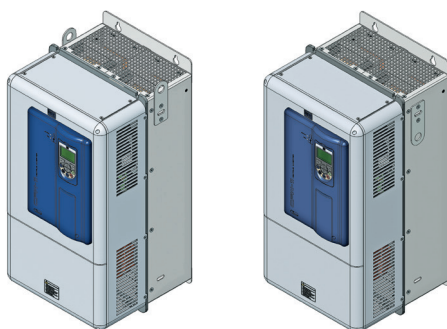

Figura 5: Remoción de la HMI y de la tapa frontal



Figura 6: Remoción de la HMI y de la tapa del rack de control de las mecánicas D, E, F y G para acceder a los terminales de control

Para tener acceso a los bornes de potencia, se debe retirar la tapa frontal inferior en las mecánicas D a G, conforme es presentado en la [figura 7](#).

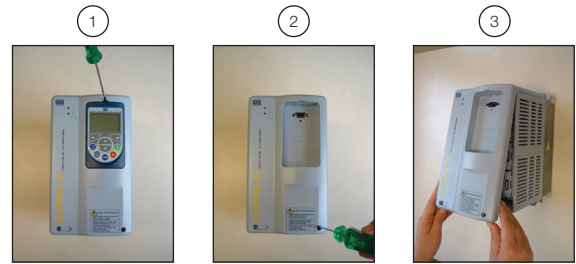

Figura 7: Remueva la tapa frontal inferior para acceder a los terminales de potencia en las mecánicas D a G

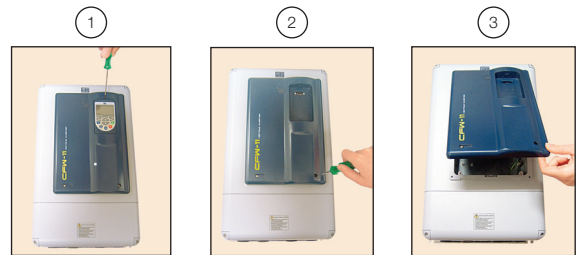
Cuando no sea necesario el grado de protección IP20 ni Nema1, la chapa de pasaje de los cables puede ser removida para facilitar la instalación eléctrica en las mecánicas D y E.

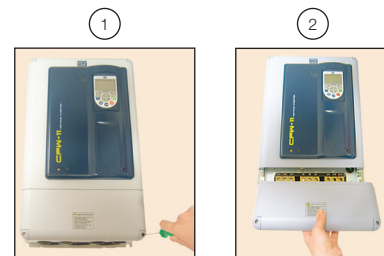

Figura 8: Retirada de la chapa de pasaje de los cables

Para la conexión de los cables de potencia (red y motor) en las mecánicas F y G es necesario retirar la chapa de protección conforme [figura 9](#).

En este caso el grado de protección de la parte inferior del convertidor será reducido.

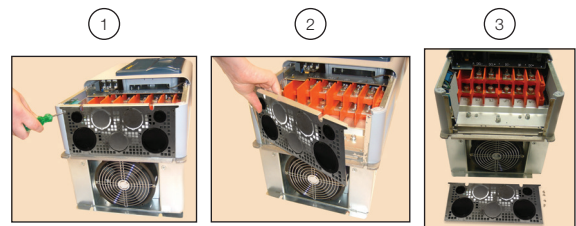

Figura 9: Retirada de la chapa de pasaje de los cables en las mecánicas F y G

INSTALACIÓN ELÉCTRICA



¡PELIGRO!
Asegúrese de que la red de alimentación está desconectada, antes de iniciar la instalación.

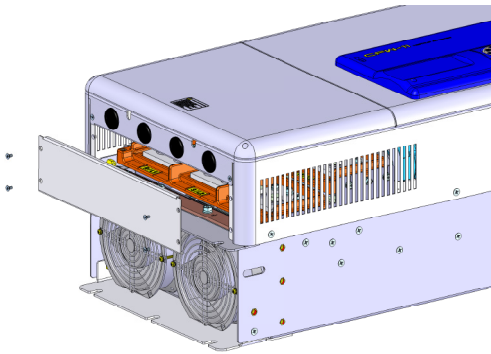

¡PELIGRO!
Las informaciones a seguir tienen la intención de servir como guía para obtenerse una instalación correcta. Siga también las normas de instalación eléctrica aplicables.



¡PELIGRO!
El convertidor será dañado si la fuente de alimentación es conectada a los terminales de salida.

DIAGRAMAS DE CONEXIÓN

Note:

Las especificaciones técnicas, incluyendo la línea de fusibles, aparecen en las [tablas A.1 y A.2](#).

Las especificaciones técnicas del resistor de frenado y de la corriente de frenado se encuentran en la [tabla A.3](#).



Figura 10: Diagrama de la conexión de potencia para los modelos estándares de las mecánicas A, B, C, D, E, F y G



Figura 11: Diagrama de la conexión de potencia de las mecánicas F y G con hardware especial DC

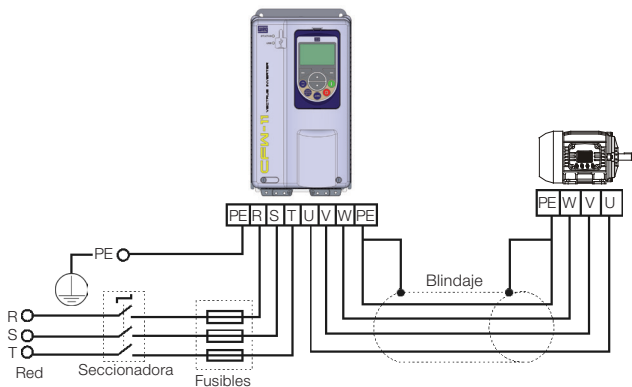

Figura 12: Diagrama de conexión del resistor de frenado en las mecánicas A, B, C, D y E

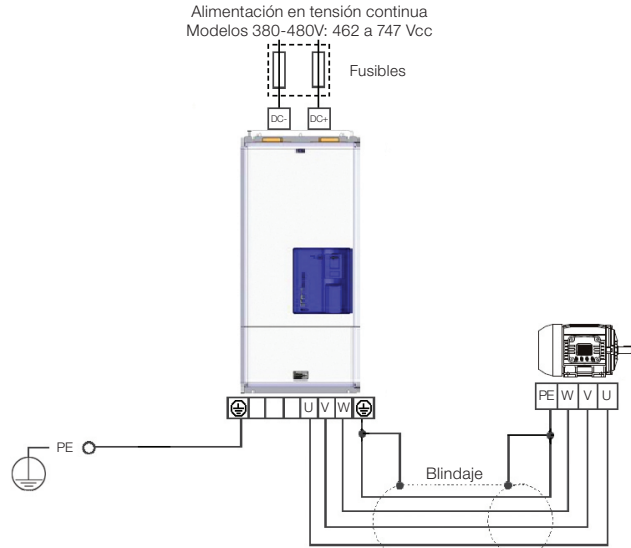

Figura 13: Diagrama de la conexión de potencia para los modelos estándares de las mecánicas F y G con resistor de frenado

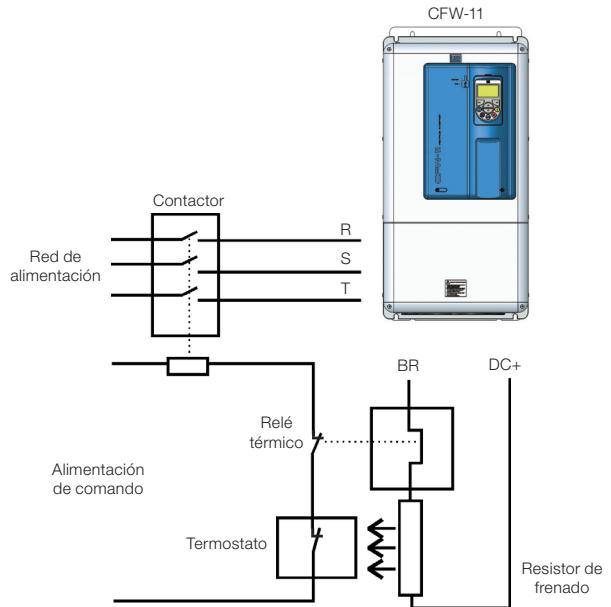

Figura 14 (a) a (c) : Terminales de potencia y puesta a tierra de las mecánicas A a E

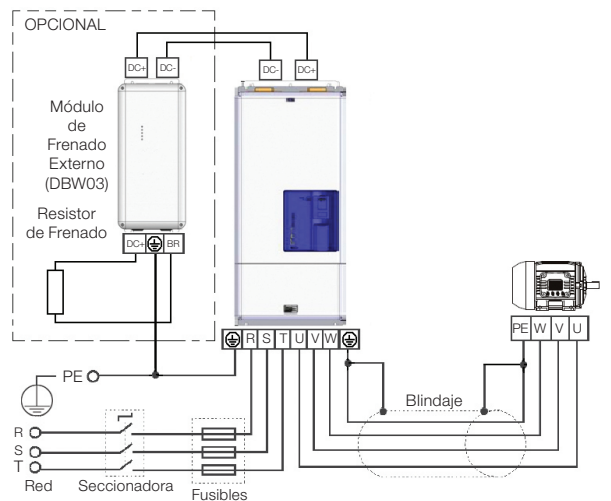

Figura 15 (a) y (b): Terminales de potencia y puesta a tierra de las mecánicas F y G

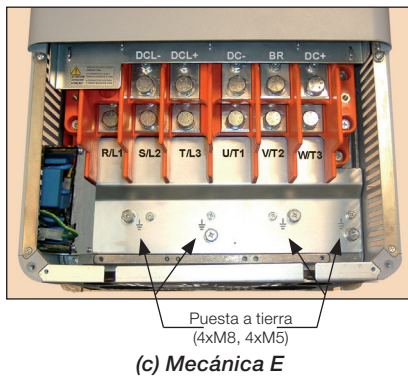
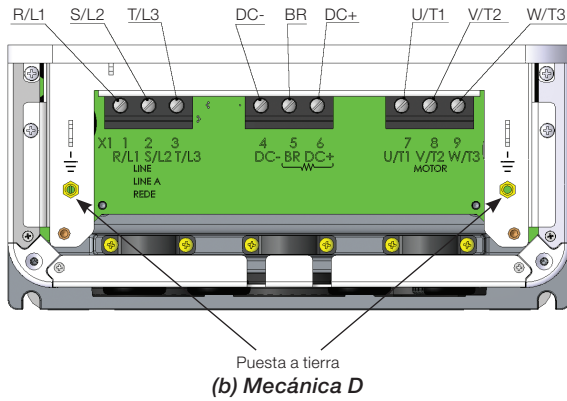
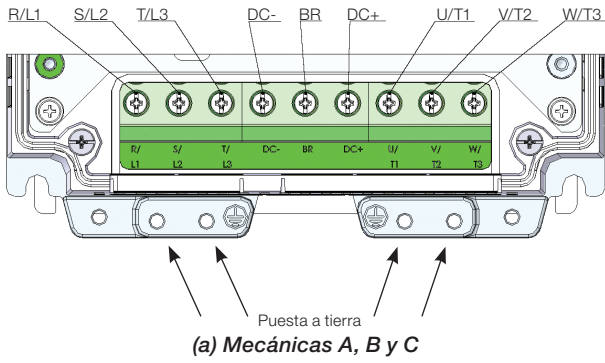

INFORMACIONES SOBRE CIRCUITOS Y DISPOSITIVOS

- La red que alimenta el convertidor debe tener el neutro sólidamente puesto a tierra. En redes IT algunos componentes deben ser desconectados conforme es presentado en las figuras 17 a 19.
- Prever un dispositivo para seccionamiento de la alimentación del convertidor. Éste debe seccionar la red de alimentación para el convertidor cuando sea necesario (por ejemplo: durante trabajos de mantenimiento).

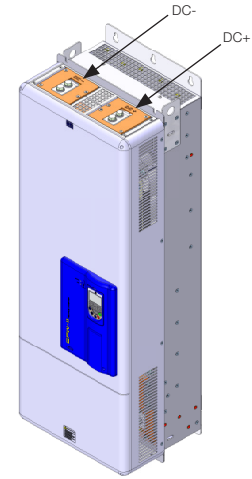
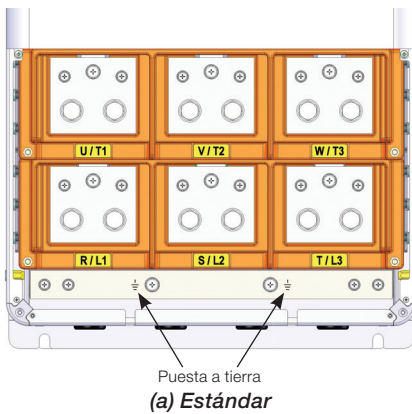
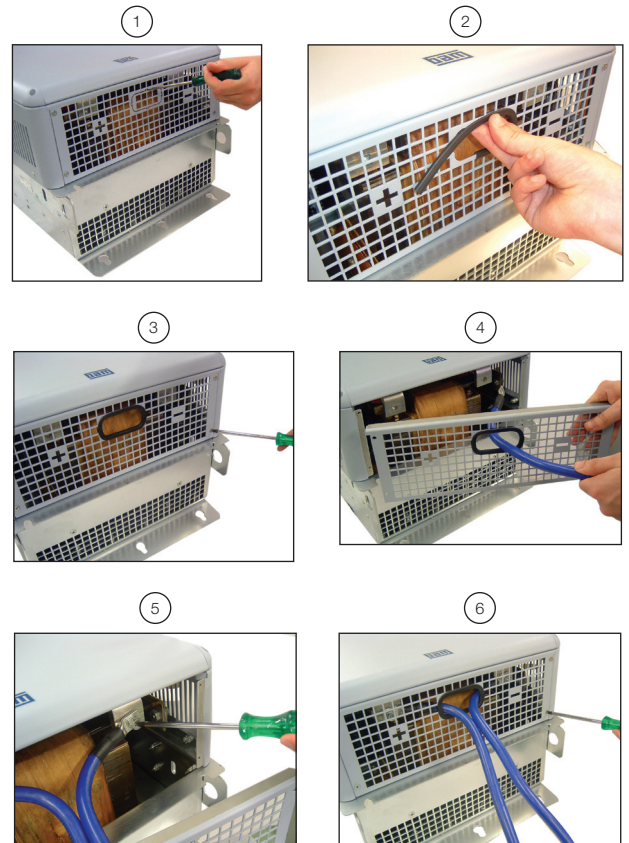
- El fusible a ser utilizado en la entrada debe ser del tipo UR (Ultra-Rápido) con I_{pt} igual o menor al indicado en las tablas A.1 y A.2 (considerar valor de extinción de corriente (no de fusión) a frío), para operación de los diodos rectificadores de entrada del convertidor y del cableado.
- Para conformidad con la norma UL, utilizar fusibles clase J en la alimentación del convertidor con corriente no mayor a los valores de las tablas A.1 y A.2.
- Opcionalmente, pueden ser utilizados en la entrada fusibles de acción retardada, dimensionados para 1.2 x corriente nominal de entrada del convertidor. En este caso, la instalación queda protegida contra cortocircuito, excepto los diodos del puente rectificador en la entrada del convertidor. Esto puede causar daños mayores al convertidor en el caso de algún componente interno fallar.
- El CFW-11 es indicado para uso en un circuito capaz de suministrar no más de 100.000 Arms simétricos (230 V / 480 V).
- Se recomienda usar cable blindado del motor conforme IEC 60034-25.
- Mantenga los cables del motor a un mínimo 25 cm de distancia de los demás cables (cables de señal, cables de sensores, cables de comando, etc.).

RED IT

Cuando el neutro no está puesto a tierra, o la puesta a tierra es hecha vía un resistor de valor óhmico alto, o en redes delta puestas a tierra ("delta corner earth").



Figura 17 (a) a (d): Localización de los tornillos de puesta a tierra – Remuévalos para red IT en las mecánicas A...D



(a) Localización de la tarjeta

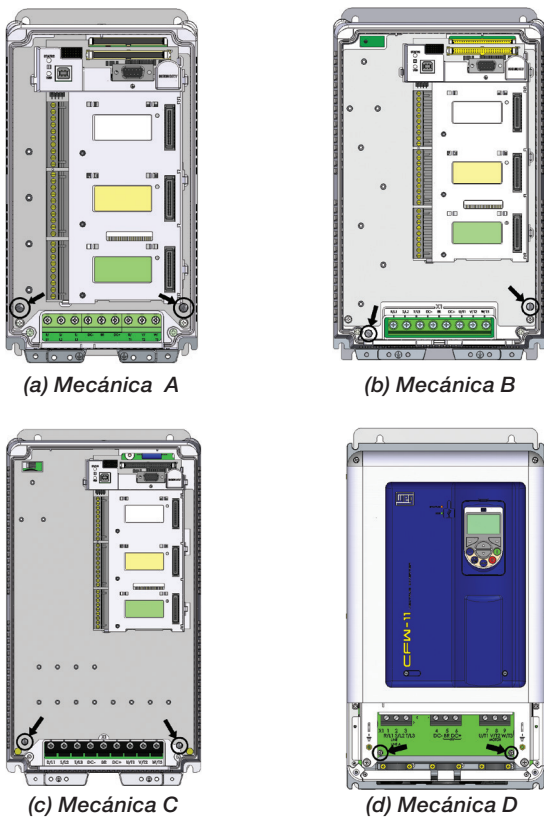
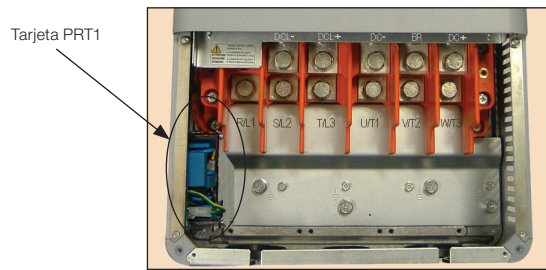
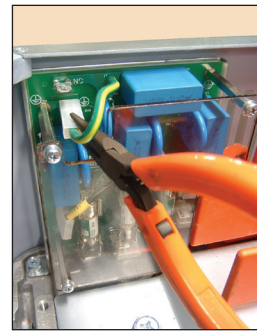

(b) Posición inicial

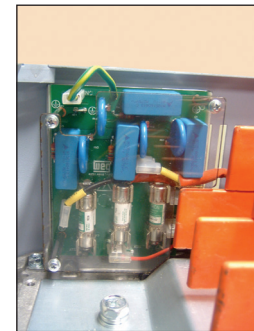

(c) Posición final

Figura 18 (a) a (c): Localización del terminal en la tarjeta PRT1 – Alterar la posición para red IT de la mecánica E

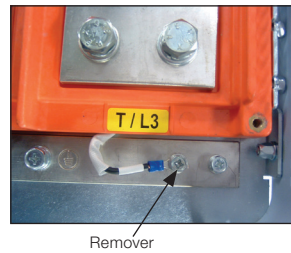

(a) Posición inicial

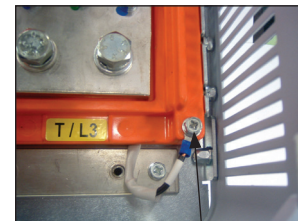

(b) Posición final (IT)

Figura 19 (a) y (b): Localización del terminal en la tarjeta PRT1 - Alterar la posición para red IT en las mecánicas F y G

CONEXIONES DE PUESTA A TIERRA



¡PELIGRO!

La puesta a tierra del convertidor debe ser conectado a tierra de protección. En caso que existan normas locales que exijan calibres diferentes, éstas deben ser seguidas. Conecte los puntos de puesta a tierra del convertidor a un asta de puesta a tierra específica, o al punto de puesta a tierra específico, o incluso, al punto de puesta a tierra general (resistencia ≤ 10 Ω). Para compatibilidad con la norma IEC 61800-5-1 utilice como mínimo un cable de cobre de 10 mm² para conexión del convertidor al tierra de protección, ya que la corriente de fuga es mayor a 3.5 mAca.



¡ATENCIÓN!

El conductor de la red que alimenta el convertidor debe ser sólidamente puesto a tierra, no obstante, el mismo no debe ser utilizado para puesta a tierra del convertidor.



Figura 20: Conexiones de puesta a tierra para más de un convertidor

CONEXIONES DE CONTROL

Las conexiones de control (entradas / salidas analógicas, entradas / salidas digitales) deben ser hechas en el conector XC1 de la Tarjeta Electrónica de Control CC11.

Conector XC1	Función Estándar de Fábrica
1	REF+ Referencia positiva para potenciómetro (5.4 V ± 5 %).
2	AI1+ Entrada analógica 1: Referencia de velocidad (remota).
3	AI1-
4	REF- Referencia negativa para potenciómetro (-4.7 V ± 5 %).
5	AI2+ Entrada analógica 2: Sin Función
6	AI2-
7	AO1 Salida analógica 1: Velocidad.
8	AGND (24 V) Referencia 0 V para salidas analógicas.
9	AO2 Salida analógica 2: Corriente del motor.
10	AGND (24 V) Referencia 0 V para salidas analógicas.
11	DGND* Referencia 0 V de la fuente de 24 Vcc.
12	CON Punto común de las entradas digitales.
13	24 Vcc Fuente de alimentación 24 Vcc.
14	CON Punto común de las entradas digitales.
15	DI1 Entrada digital 1: Gira/Para
16	DI2 Entrada digital 2: Sentido de giro (remoto).
17	DI3 Entrada digital 3: Sin función.
18	DI4 Entrada digital 4: Sin función.
19	DI5 Entrada digital 5: Jog (remoto).
20	DI6 Entrada digital 6: 2º Rampa.
21	NC1 Salida digital 1 DO1 (RL1): Sin falla
22	C1
23	NO1
24	NC2 Salida digital 2 DO2 (RL2): N > N _x - Velocidad > P0288.
25	C2
26	NO2
27	NC3 Salida digital 3 DO3 (RL3): N* > N _x - Referencia de velocidad > P0288.
28	C3
29	NO3

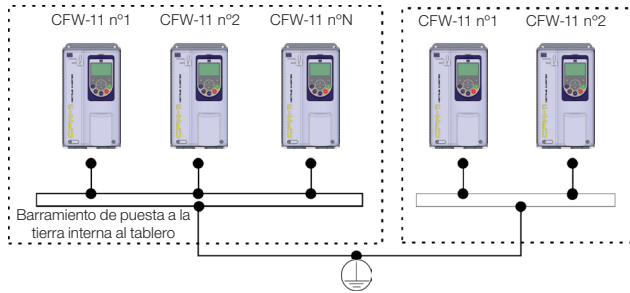
Figura 21: Señales en el conector XC1 – Entradas digitales como activo alto



¡NOTA!

Para utilizar las entradas digitales como activo bajo es necesario remover el jumper que conecta XC1:11 y 12 y pasar para XC1:12 y 13 y conectar el punto común que conecta las DIP Switches DI1 a DI6 del conector XC1:11, al revés de XC1:13.

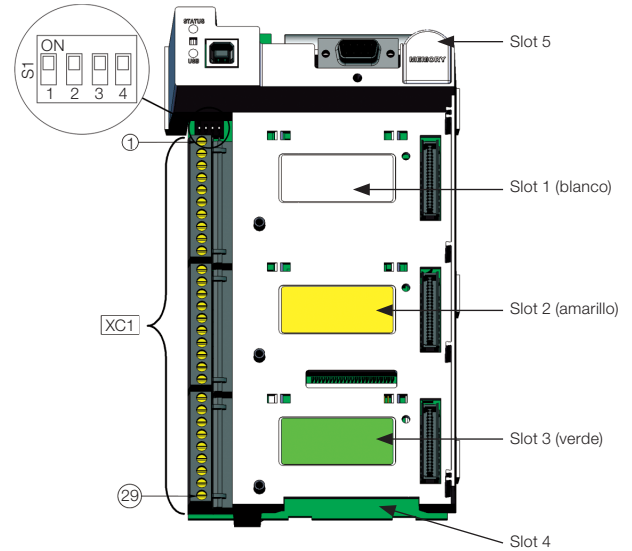

Señal	Función Padrón de Fábrica	Elemento de Ajustar	Selección	Ajuste de Fábrica
AI1	Referencia de Velocidad (remoto)	S1.4	OFF: 0 a 10 V (padrón de fábrica) ON: 4 a 20 mA / 0 a 20 mA	OFF
AI2	Sin Función	S1.3	OFF: 0 a ±10 V (padrón de fábrica) ON: 4 a 20 mA / 0 a 20 mA	OFF
AO1	Velocidad	S1.1	OFF: 4 a 20 mA / 0 a 20 mA ON: 0 a 10 V (padrón de fábrica)	ON
AO2	Corriente del Motor	S1.2	OFF: 4 a 20 mA / 0 a 20 mA ON: 0 a 10 V (padrón de fábrica)	ON

Figura 22: Configuración de las llaves para selección del tipo de señal en las entradas y salidas analógicas



¡NOTA!

Para obtener más informaciones referentes a la función Parada de Seguridad (STO), consulte la Guía de Instalación, Configuración y Operación.

Conexiones Típicas de Control

Accionamiento 1 - Función Gira/Para con comando vía HMI (Modo Local).

Con la programación estándar de fábrica es posible la operación del convertidor en el modo local. Se recomienda este modo de operación para usuarios que estén utilizando el convertidor por primera vez, como forma de aprendizaje, sin conexiones adicionales en el control.

Accionamiento 2 - Función Gira/Para con comando a dos cables (Modo Remoto).

Válido para programación estándar de fábrica y convertidor operando en el modo remoto.

En el estándar de fábrica, la selección del modo de operación (local/remoto) es hecha por la tecla (default local).

Para pasar la programación default de la tecla para remoto, hacer P0220=3.



Figura 23: Conexiones en XC1 para accionamiento 2

Accionamiento 3 - Función Start/Stop con comando a tres cables.

Habilitación de la función Gira/Para con comando a 3 cables.

Parámetros a programar:

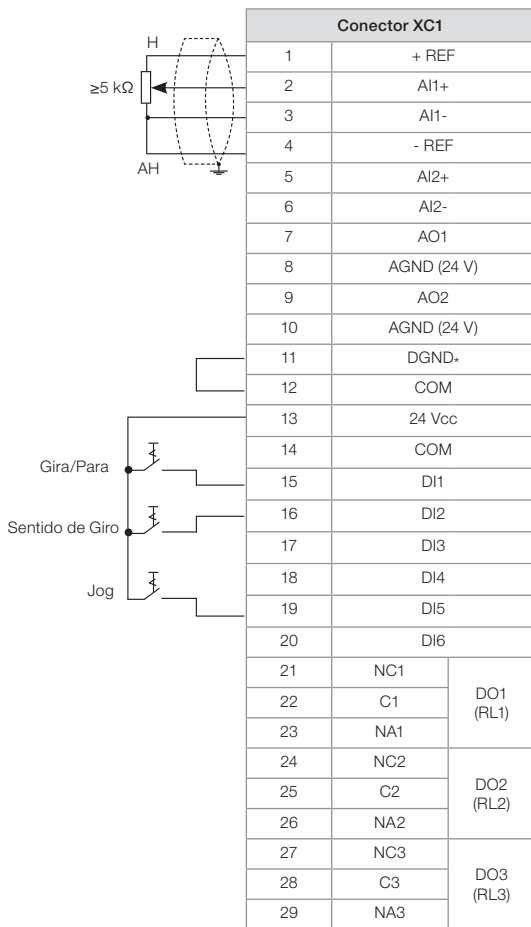
Programar DI3 para START P0265=6

Programar DI4 para STOP P0266=7

Programa P0224=1 (DIx) en caso que desee el comando a 3 cables en modo Local.

Programa P0227=1 (DIx) en caso que desee el comando a 3 cables en modo Remoto.

Programar Sentido de Giro por la DI2.

Programa P0223=4 para Modo Local o P0226=4 para Modo Remoto.

S1 y S2 son botoneras pulsantes enciende (contacto NA) y apaga (contacto NC) respectivamente.

La referencia de velocidad puede ser vía entrada analógica AI (como en el Accionamiento 2), vía HMI (como en el Accionamiento 1) u otra fuente.



Figura 24: Conexiones en XC1 para accionamiento 3

Accionamiento 4 - Avance/Retorno.

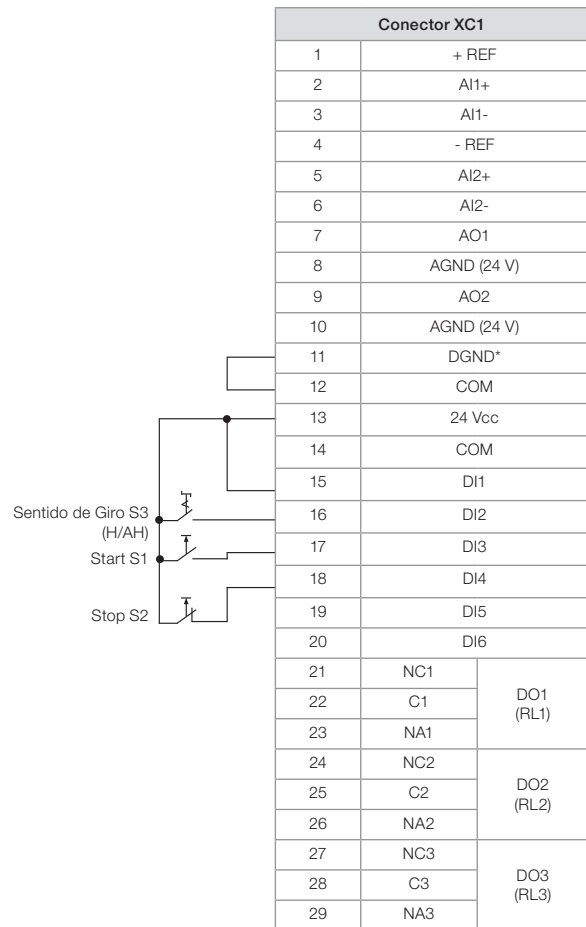

Habilitación de la función Avance/Retorno.

Parámetros a programar:

Programar DI3 para AVANCE P0265=4

Programar DI4 para RETORNO P0266=5

Cuando la función Avance/Retorno sea programada, la misma estará activa, tanto en modo local como remoto. Al mismo tiempo, las teclas

 y  quedan siempre inactivas (aunque P0224=0 ó P0227=0). El sentido de giro es definido por las entradas de avance y retorno. Rotación horaria para avance y antihoraria para retorno.

La referencia de velocidad puede ser proveniente de cualquier fuente (como en el Accionamiento 3).





Figura 25: Conexiones en XC1 para Accionamiento 4

INSTALACIONES DE ACUERDO CON LA DIRECTIVA EUROPEA DE COMPATIBILIDAD ELECTROMAGNÉTICA

Los convertidores en las mecánicas A a D con la opción FA (CFW11XXXXXOFA) y en los convertidores estándar de las otras mecánicas posee filtro RFI interno para reducción de la interferencia electromagnética.

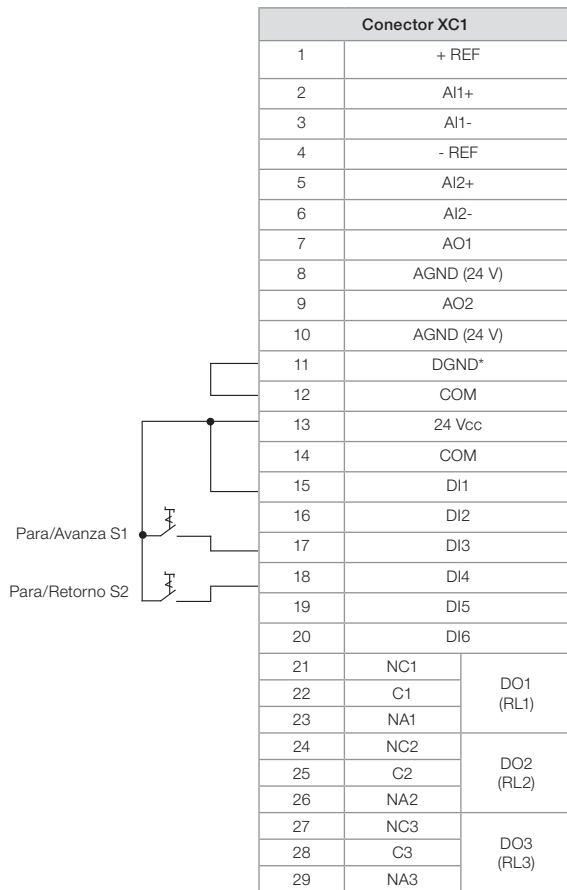
Estos convertidores, cuando son correctamente instalados, atienden los requisitos de la directiva de compatibilidad electromagnética "EMC Directive 2004/108/EC".



¡ATENCIÓN!
Para utilizar modelos con filtro RFI interno en redes IT, siga las instrucciones descritas en las figuras 17 a 19.

Instalación Conforme

Para la instalación conforme, utilice:

1. Convertidores en las mecánicas A a D: con la opción filtro RFI interno CFW11XXXXXOFA y otros modelos estándar.
2. Cables de salida (cables del motor) blindados y con el blindaje conectado en ambos lados, motor y convertidor, con conexión de baja impedancia para alta frecuencia. Longitud máxima del cable del motor y niveles de emisión conducida y radiada de acuerdo con las tablas 2 y 3. Si se desea el nivel de emisión inferior y/o mayor longitud del cable del motor, utilice filtro RFI externo en la entrada del convertidor. Para más informaciones (referencia comercial del filtro RFI, longitud del cable del motor y niveles de emisión) consulte las tablas 2 y 3.
3. Cables de control blindado.
4. Convertidor sólidamente puesto a tierra.

Tabla 2: Niveles de emisión conducida y radiada en las mecánicas A a D

Modelo del Convertidor (Con Filtro RFI Interno)	Sin filtro RFI externo			Con Filtro RFI Externo				
	Emisión Conducida - Longitud Máxima del Cable del Motor	Emisión Radiada	Referencia Comercial del Filtro RFI Externo (Fabricante: EPCOS)	Emisión Conducida - Longitud Máxima del Cable del Motor		Emisión Radiada - Categoría		
				Categoría C3	Categoría C2	Categoría C2	Categoría C1	Sin Tablero Metálico
	Categoría C3	Categoría C2	Categoría (No es Necesario Usar Tablero Metálico)	Categoría C2	Categoría C1	Sin Tablero Metálico	Dentro de Tablero Metálico	
CFW11 0006 S 2 O FA	100 m	7 m	C2	B84142-A16-R122	75 m	50 m	C2	C2
				B84142-B16-R	100 m	100 m		
CFW11 0007 T 2 O FA	100 m	5 m	C2	B84143-G8-R110	100 m	-	C2	C2
				B84143-A8-R105	50 m	50 m		
CFW11 0007 S 2 O FA	100 m	7 m	C2	B84142-A16-R122	75 m	50 m	C2	C2
				B84142-B16-R	100 m	100 m		
CFW11 0010 S 2 O FA	100 m	7 m	C2	B84142-A30-R122	75 m	50 m	C2	C2
				B84142-B25-R	100 m	100 m		
CFW11 0010 T 2 O FA	100 m	5 m	C2	B84143-G20-R110	100 m	-	C2	C2
				B84143-A16-R105	50 m	50 m		
CFW11 0013 T 2 O FA	100 m	5 m	C2	B84143-G20-R110	100 m	-	C2	C2
				B84143-A16-R105	50 m	50 m		
CFW11 0016 T 2 O FA	100 m	5 m	C2	B84143-G20-R110	100 m	-	C2	C2
				B84143-A25-R105	50 m	50 m		
CFW11 0024 T 2 O FA	100 m	No	C2	B84143-A36-R105	100 m	100 m	C2	C2
CFW11 0028 T 2 O FA	100 m	No	C2	B84143-A36-R105	100 m	100 m	C2	C2
CFW11 0033 T 2 O FA	100 m	No	C2	B84143-A50-R105	100 m	100 m	C2	C2
CFW11 0045 T 2 O FA	100 m	No	C3	B84143-A50-R105	100 m	100 m	C3	C2
CFW11 0054 T 2 O FA	100 m	No	C3	B84143-A66-R105	100 m	100 m	C3	C2
CFW11 0070 T 2 O FA	100 m	No	C3	B84143-A90-R105	100 m	100 m	C3	C2
CFW11 0086 T 2 O FA	100 m	No	C3	B84143-A120-R105	100 m	100 m	C3	C2
CFW11 0105 T 2 O FA	100 m	No	C3	B84143-A120-R105	100 m	100 m	C3	C2
CFW11 0003 T 4 O FA	100 m	5 m	C2	B84143-G8-R110	100 m	-	C2	C2
				B84143-A8-R105	50 m	50 m		
CFW11 0005 T 4 O FA	100 m	5 m	C2	B84143-G8-R110	100 m	-	C2	C2
				B84143-A8-R105	50 m	50 m		
CFW11 0007 T 4 O FA	100 m	5 m	C2	B84143-G8-R110	100 m	-	C2	C2
				B84143-A8-R105	50 m	50 m		
CFW11 0010 T 4 O FA	100 m	5 m	C2	B84143-G20-R110	100 m	-	C2	C2
				B84143-A16-R105	50 m	50 m		
CFW11 0013 T 4 O FA	100 m	5 m	C2	B84143-G20-R110	100 m	-	C2	C2
				B84143-A16-R105	50 m	50 m		
CFW11 0017 T 4 O FA	100 m	No	C2	B84143-A25-R105	100 m	100 m	C2	C2
CFW11 0024 T 4 O FA	100 m	No	C2	B84143-A36-R105	100 m	100 m	C2	C2
CFW11 0031 T 4 O FA	100 m	No	C2	B84143-A36-R105	100 m	100 m	C2	C2
CFW11 0038 T 4 O FA	100 m	No	C3	B84143-A50-R105	100 m	100 m	C3	C2
CFW11 0045 T 4 O FA	100 m	No	C3	B84143-A50-R105	100 m	100 m	C3	C2
CFW11 0058 T 4 O FA	100 m	No	C3	B84143-A66-R105	100 m	100 m	C3	C2
CFW11 0070 T 4 O FA	100 m	No	C3	B84143-A90-R105	100 m	100 m	C3	C2
CFW11 0088 T 4 O FA	100 m	No	C3	B84143-A120-R105	100 m	100 m	C3	C2

Tabla 3: Niveles de emisión conducida y radiada en las mecánicas E, F y G

Modelo del Convertidor (Con Filtro RFI Interno)	Mecánica	Sin filtro RFI externo		Con Filtro RFI Externo		
		Emisión Conducida - Longitud Máxima del Cable del Motor	Emisión Radiada	Referencia Comercial del Filtro RFI Externo (Fabricante: EPCOS)	Emisión Conducida - Longitud Máxima del Cable del Motor	Emisión Radiada - Categoría
		Categoría C3	Categoría		Categoría C2	Categoría
CFW11 0142 T2		100 m (328.10 ft)	C2	B84143-B0150-S020	100 m (328.10 ft)	C2
CFW11 0180 T2		100 m (328.10 ft)	C2	B84143-B0180-S020 (1)	100 m (328.10 ft)	C2
CFW11 0211 T2		100 m (328.10 ft)	C2	B84143-B0250-S020 (2)	100 m (328.10 ft)	C2
CFW11 0105 T4	E	100 m (328.10 ft)	C2	B84143-B0150-S020	100 m (328.10 ft)	C2
CFW11 0142 T4		100 m (328.10 ft)	C2	B84143-B0150-S020	100 m (328.10 ft)	C2
CFW11 0180 T4		100 m (328.10 ft)	C2	B84143-B0180-S020 (1)	100 m (328.10 ft)	C2
CFW11 0211 T4		100 m (328.10 ft)	C2	B84143-B0250-S020 (2)	100 m (328.10 ft)	C2
CFW11 0242 T4		100 m (328.10 ft)	C3 (3)	B84143-B0250-S021	100 m (328.10 ft) (4)	C3
CFW11 0312 T4		100 m (328.10 ft)	C3 (3)	B84143-B01420-S021	100 m (328.10 ft) (4)	C3
CFW11 0370 T4	F	100 m (328.10 ft)	C3 (3)	B84143-B0400-S021	100 m (328.10 ft) (4)	C3
CFW11 0477 T4		100 m (328.10 ft)	C3 (3)	B84143-B0600-S021	100 m (328.10 ft) (4)	C3
CFW11 0515 T4		100 m (328.10 ft)	C3 (3)	B84143-B0600-S021	100 m (328.10 ft) (4)	C3
CFW11 0601 T4	G	100 m (328.10 ft)	C3 (3)	B84143-B0600-S021	100 m (328.10 ft) (4)	C3
CFW11 0720 T4		100 m (328.10 ft)	C3 (3)	B84143-B1000-S021	100 m (328.10 ft) (4)	C3

Notas de la tabla 3:

- (1) Para temperatura ambiente alrededor del convertidor/filtro mayor a 40 °C (104 °F) y corriente de salida continua mayor a 172 Arms, es necesario utilizar filtro B84143B0250S020.
- (2) Para temperatura ambiente alrededor del convertidor/filtro de 40 °C (104 °F) y aplicaciones con régimen de sobrecarga pesada (HD, corriente de salida < 180 Arms), es posible utilizar el filtro B84143B0180S020.
- (3) Con el transformador de corriente en los tres cables de alimentación. Ejemplo: TDK PN: PC40 UU120x160x20.
- (4) Frecuencia mínima de operación 2,5 Hz.

INTERFAZ HOMBRE-MÁQUINA- HMI-CFW-11



Figura 26: Teclas y funciones de la HMI



Figura 27: Display de la HMI y ejemplos de la función estándar de fábrica (modo monitoreo)



Figura 28: Localización de la tapa de acceso a la batería

Notas de la HMI:

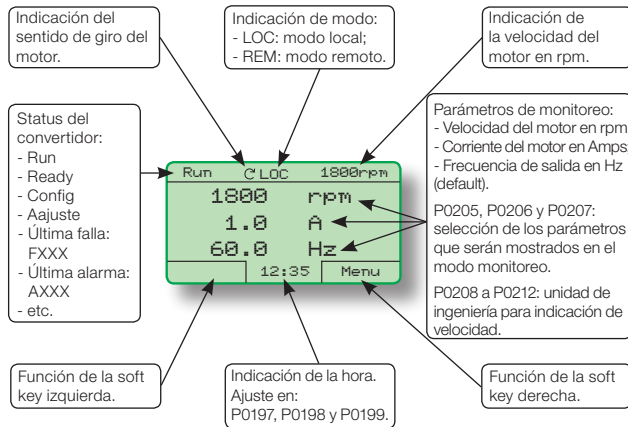
- La HMI puede ser conectada con el convertidor energizado.
- Pueden ser programados otros modos de visualización, tales como gráfico de barras y caracteres mayores, a través de ajuste de los parámetros P0205-207 y P0208-212.
- La batería es usada solamente para mantener el funcionamiento del reloj interno cuando el convertidor sea desenergizado. Si la batería está completamente descargada o si no está instalada en la HMI, la hora exhibida por el reloj será inválida y ocurrirá la indicación de "A181 - Reloj de tiempo inválido", cada vez que el convertidor sea energizado.
- Al fin de la vida útil de la batería, no depositar la misma en un basurero común y si en un local apropiado para depósito de baterías.

ESTRUCTURA DE PARÁMETROS

Cuando es presionada la tecla soft key derecha en modo monitoreo ("MENU") son mostrados en el display los grupos de parámetros. El número y el nombre de los grupos pueden cambiar dependiendo de la versión de software utilizada.

START-UP

¡PELIGRO!
El convertidor será dañado en caso de que la potencia de la alimentación de entrada sea conectada a los terminales de salida.

ANTES DE LA ENERGIZACIÓN

- 1) Verifique si las conexiones de potencia, puesta a tierra y de control están correctas y firmes.
- 2) Retire todos los restos de materiales del interior del convertidor o accionamiento.
- 3) Verifique las conexiones del motor y si la corriente y tensión del motor están de acuerdo con el convertidor.
- 4) Desacople mecánicamente el motor de la carga:
Si el motor no puede ser desacoplado, verifique que el giro en cualquier dirección (horario o antihorario) no causará daños a la máquina o riesgo de accidentes.
- 5) Cierre las tapas del convertidor o accionamiento.
- 6) Meza la tensión de la red y verifique que esté dentro del rango permitido.
- 7) Energice la entrada:
Cierre la seccionadora de entrada.
- 8) Verifique el éxito de la energización:
El display debe mostrar en la pantalla el modo monitoreo estándar y el led de estado debe encenderse y permanecer encendido en color verde.

ARRANQUE EN EL MODO V/f

La puesta en funcionamiento en el modo V/f es explicada de forma simple en 3 pasos, usando las facilidades de programación con los grupos de parámetros existentes **Start-Up Orientado** y **Aplicación Básica**.

1) Ajuste de la Contraseña en P0000

Sec.	Acción/Resultado	Indicación en el display
1	- Modo Monitoreo. - Presione " Menú " ("soft key" derecho).	
2	- El grupo " 00 TODOS PARÁMETROS " ya está seleccionado. - Presione " Selecc. ".	
3	- El parámetro " Acceso Parámetro P0000: 0 " ya está seleccionado. - Presione " Selecc. ".	
4	- Para ajustar la contraseña, presione hasta el número 5 aparecer en el display.	
5	- Cuando el número 5 aparecer, presione " Salvar ".	
6	- Si el ajuste fue correctamente realizado, el display debe presentar " Acceso Parámetro P0000: 5 ". - Presione " Salir " (soft key izquierdo).	
7	- Presione " Salir ".	
8	- El display regresa para el Modo Monitoreo.	

Figura 29: Procedimientos para permitir la modificación de los parámetros a través de P0000

2) Start-up Orientado

Para facilitar el ajuste del convertidor existe un grupo de parámetros llamado de Start-up Orientado. Dentro de este grupo existe el parámetro P0317, a través del cual se puede entrar en la rutina de Start-up Orientado.

La rutina de Start-Up Orientado presenta en la HMI los principales parámetros en una secuencia lógica. Los parámetros mínimos necesarios para el funcionamiento adecuado son ajustados. Son presentadas informaciones como tensión de alimentación y datos de placa del motor.

Para entrar en la rutina de Start-up Orientado siga la secuencia, primeramente alterando P0317=1 y luego ajustando los otros parámetros a medida que éstos van siendo mostrados en el display de la HMI.

El ajuste de los parámetros presentados en este modo de funcionamiento resulta en la modificación automática del contenido de otros parámetros y/o variables internas del convertidor.

Durante la rutina de Start-Up Orientado será indicado el estado "Config" (Configuración) en el ángulo superior izquierdo de la HMI.

3) Ajuste de los Parámetros de la Aplicación Básica

Luego de ser ejecutada la rutina de Start-up Orientado y ajustado correctamente los parámetros, el convertidor estará pronto para operar en modo V/f.

El grupo Aplicación Básica tiene los parámetros de aplicación más comunes.

CONFIGURACIÓN DE FECHA Y HORA

Acceder a la HMI grupo y el cambio: día (P0194), mes (P0195), año (P0196), horas (P0197), minutos (P0198) y segundos (P0199).

BLOQUEO DE LA MODIFICACIÓN DE LOS PARÁMETROS

En caso de se quiera evitar la alteración de parámetros por personas no autorizadas, altere el contenido de P0000 para un valor diferente de 5.

FUNCIONES DEL MÓDULO DE MEMÓRIA FLASH

- Almacena la imagen de los parámetros del convertidor.
- Permite transferir parámetros almacenados en el módulo de memoria FLASH para el convertidor.
- Permite transferir el firmware almacenado en el módulo de memoria FLASH para el convertidor.
- Almacena el programa generado por el SoftPLC.

Siempre que el convertidor es energizado, transfiere este programa para la memoria RAM, localizada en la tarjeta de control del convertidor, y ejecuta el programa.

Para más detalles consulte el manual de programación y el manual SoftPLC del CFW-11.

Tabla A.2: Especificaciones técnicas de las mecánicas E a G

Modelo	Mecánica	Alimentación	Uso en Régimen de Sobrecarga Normal (ND)						Uso en Régimen de Sobrecarga Pesada (HD)						Peso [kg (lb)]	Fusible [A] de acuerdo con la Normativa Europea IEC	Fusible I ² t [A ² s] @ 25 °C	Temperatura Ambiente en las Proximidades del Convertidor de Frecuencia [°C (°F)]	Frenado Reostático	Opcionales Disponibles que Pueden ser Agregados al Producto	
			Corriente de Sobrecarga (2) [Arms]	1 min	3 s	Corriente de Salida Nominal (1) [Arms]	Potencia Disipada [W]	Montaje en Superficie "Flange"	Corriente de Entrada Nominal [Arms]	Motor Máximo [HP/kW]	Frecuencia de Conmutación Nominal [kHz]	Corriente de Sobrecarga (2) [Arms]	1 min	3 s						Corriente de Salida Nominal (1) [Arms]	Potencia Disipada [W]
CFW11 0142 T 2		3ø	142	156.2	213	2.5	50/37	142	1490	210	115	172.5	230	5	40/30	115	1280	200	Nema 1 (kit KNIE-01)		
CFW11 0180 T 2		3ø	180	198	270	2.5	60/45	180	1820	360	142	213	284	5	50/37	142	1550	350	Nema 1 (kit KNIE-02)		
CFW11 0211 T 2		3ø	211	232	317	2.5	75/55	211	2040	360	180	270	360	2.5	75/55	180	1690	350		Posee	
CFW11 0105 T 4	E	3ø	105	115.5	157.5	2.5	75/55	105	1270	200	88	132	176	2.5	60/45	88	1020	190			
CFW11 0142 T 4		3ø	142	156.2	213	2.5	100/75	142	1680	210	115	172.5	230	2.5	75/55	115	1290	200			
CFW11 0180 T 4		3ø	180	198	270	2.5	150/110	180	2050	360	142	213	284	2.5	100/75	142	1570	350			
CFW11 0211 T 4		3ø	211	232.1	317	2.5	175/132	211	2330	360	180	270	360	2.5	150/110	180	1940	350			
CFW11 0242 T 4		3ø	242	266	363	2.5	200/150	242	1518	285	211	317	422	2.5	175/132	211	1277	227			
CFW11 0312 T 4		3ø	312	343	468	2.5	250/185	312	2034	375	242	363	484	2.5	200/150	242	1507	292			
CFW11 0370 T 4	F	3ø	370	407	555	2.5	300/220	370	2497	407	312	468	624	2.5	250/185	312	2008	320			
CFW11 0477 T 4		3ø	477	525	716	2.5	400/300	477	3273	595	370	555	740	2.5	300/220	370	2451	465			
CFW11 0515 T 4		3ø	515	567	773	2	400/300	515	3338	769	477	716	954	2	400/300	477	2987	644			
CFW11 0601 T 4	G	3ø	601	662	900	2	500/370	601	3875	781	515	773	1030	2	400/300	515	3219	639			
CFW11 0720 T 4		3ø	720	792	1080	2	600/440	720	4576	858	560	840	1120	2	450/330	560	3747	653			
Modelos con alimentación en 380... 440 V																					

Notas:

- (1) Corriente nominal en régimen permanente en las siguientes condiciones:
 - Frecuencias de conmutación específicas.
 - Temperatura del ambiente al redor del convertidor de frecuencia conforme especificado en las tablas. Para temperaturas mayores, limitado a 10 °C por encima de la temperatura máxima especificada para las condiciones nominales, la corriente de salida debe ser reducida de 2 % para cada °C arriba de la temperatura máxima especificada.
 - Humedad relativa del aire: 5 % a 90 % sin condensación.
 - Altitud: 1000 m. Arriba de 1000 metros hasta 4000 metros la corriente de salida debe ser reducida de 1 % para cada 100 m arriba de 1000 m.
 - Ambiente con grado de contaminación 2 (conforme EN50178 y UL5080).
- (2) Las potencias de los motores son solamente referenciales para motor WEG V30 o 460 Vca, 4 polos. El dimensionado correcto debe ser hecho en función de las corrientes nominales de los motores utilizados.

Tabla A.3: Especificaciones del frenado reostático para mecánicas A a E

Modelo del Convertidor	Corriente Máxima de Frenado (I_{max}) [A]	Potencia Máxima (de pico) de Frenado (P_{max}) ⁽²⁾ [kW]	Corriente Eficaz de Frenado (I_{eficaz}) [A]	Potencia (media) Disipada en el Resistor de Frenado (P_R) ⁽²⁾ [kW]	Resistor Recomendado [Ω]	Cableado de Potencia (bornes DC+ y BR) [mm ² (AWG)]
CFW11 0006 B 2	5.3	2.1	5.2	2.03	75	1.5 (16)
CFW11 0006 S 2 O FA	5.3	2.1	5.2	2.03	75	1.5 (16)
CFW11 0007 B 2	7.1	2.9	6.96	2.71	56	1.5 (16)
CFW11 0007 S 2 O FA	7.1	2.9	6.96	2.71	56	1.5 (16)
CFW11 0007 T 2	5.3	2.1	5.2	2.03	75	1.5 (16)
CFW11 0010 S 2	11.1	4.4	10.83	4.22	36	2.5 (14)
CFW11 0010 T 2	7.1	2.9	6.96	2.71	56	1.5 (16)
CFW11 0013 T 2	11.1	4.4	8.54	2.62	36	2.5 (14)
CFW11 0016 T 2	14.8	5.9	14.44	5.63	27	4 (12)
CFW11 0024 T 2	26.7	10.7	19.15	5.5	15	6 (10)
CFW11 0028 T 2	26.7	10.7	18.21	4.97	15	6 (10)
CFW11 0033 T 2	26.7	10.7	16.71	4.19	15	6 (10)
CFW11 0045 T 2	44	17.6	33.29	10.1	9.1	10 (8)
CFW11 0054 T 2	48.8	19.5	32.17	8.49	8.2	10 (8)
CFW11 0070 T 2	48.8	19.5	26.13	5.6	8.2	6 (8)
CFW11 0086 T 2	93	37.2	90.67	35.3	4.3	35 (2)
CFW11 0105 T 2	111.1	44.4	90.87	29.7	3.6	35 (2)
CFW11 0003 T 4	3.6	2.9	3.54	2.76	220	1.5 (16)
CFW11 0005 T 4	5.3	4.3	5.2	4.05	150	1.5 (16)
CFW11 0007 T 4	5.3	4.3	5.2	4.05	150	1.5 (16)
CFW11 0010 T 4	8.8	7	8.57	6.68	91	2.5 (14)
CFW11 0013 T 4	10.7	8.5	10.4	8.11	75	2.5 (14)
CFW11 0017 T 4	12.9	10.3	12.58	9.81	62	2.5 (12)
CFW11 0024 T 4	17	13.6	16.59	12.9	47	4 (10)
CFW11 0031 T 4	26.7	21.3	20.49	12.6	30	6 (10)
CFW11 0038 T 4	36.4	29.1	26.06	14.9	22	6 (8)
CFW11 0045 T 4	47.1	37.6	40	27.2	17	10 (8)
CFW11 0058 T 4	53.3	42.7	31.71	15.1	15	10 (8)
CFW11 0070 T 4	66.7	53.3	42.87	22.1	12	10 (6)
CFW11 0088 T 4	87.9	70.3	63.08	36.2	9.1	25 (4)
CFW11 0142 T 2 O DB	266.7	106.7	142	30.2	1.5	70 (2/0) o 2x 25 (2x 4)
CFW11 0180 T 2 O DB	266.7	106.7	180	48.6	1.5	120 (4/0) o 2x 35 (2x 2)
CFW11 0211 T 2 O DB	333.3	133.3	211	53.4	1.2	150 (300) o 2x 50 (2x 1)
CFW11 0105 T 4 O DB	186	148.8	105	47.4	4.3	50 (1)
CFW11 0142 T 4 O DB	266.7	213.3	142	60.5	3	70 (2/0) o 2x 25 (2x 4)
CFW11 0180 T 4 O DB	266.7	213.3	180	97.2	3	120 (4/0) o 2x 35 (2x 2)
CFW11 0211 T 4 O DB	363.6	290.9	191.7	80.8	2.2	120 (250) o 2x 50 (2x 1)

Notas:

(1) La corriente eficaz de frenado presentada es apenas un valor ilustrativo, ya que depende de la razón cíclica del frenado en la aplicación. Para obtener la corriente eficaz de frenado utilice la ecuación de abajo, donde t_{br} es dado en minutos y corresponde a la suma de los tiempos de actuación del frenado durante el más severo ciclo de 5 minutos.

$$I_{eficaz} = I_{m\acute{a}x} \cdot \sqrt{\frac{t_{br}}{5}}$$

(2) Los valores de P_{max} y P_R (potencia máxima y media del resistor de frenado respectivamente) presentados son válidos para los resistores recomendados y para las corrientes eficaces de frenado presentados en la tabla de arriba. La potencia del resistor debe ser modificada de acuerdo con la razón cíclica del frenado.



Inversor de Frequência

Guia de Instalação

Série: CFW-11

Idioma: Português

Documento: 10001803811 / 00

Data de Publicação: 01/2013

PORTUGUÊS

DEUTSCH

FRANÇAIS

РУССКИЙ

NEDERLANDS

ITALIANO

SUMÁRIO

SOBRE O GUIA	47
INSTRUÇÕES DE SEGURANÇA.....	47
DESCRIÇÃO PRINCIPAL DO CFW-11	47
RECEBIMENTO E ARMAZENAMENTO.....	47
INSTALAÇÃO MECÂNICA.....	47
CONSIDERAÇÕES GERAIS DE MONTAGEM.....	47
MONTAGEM EM PAINEL	47
INSTALAÇÃO ELÉTRICA.....	50
DIAGRAMAS DE CONEXÃO	50
INFORMAÇÕES SOBRE CIRCUITOS E DISPOSITIVOS.....	51
REDE IT.....	52
CONEXÕES DE ATERRAMENTO	52
CONEXÕES DE CONTROLE.....	53
INSTALAÇÕES DE ACORDO COM A DIRETIVA EUROPÉIA	
DE COMPATIBILIDADE ELETROMAGNÉTICA	55
INTERFACE HOMEM-MÁQUINA- HMI-CFW-11	56
ESTRUTURA DE PARÂMETROS.....	57
START-UP	57
ANTES DA ENERGIZAÇÃO	57
PARTIDA NO MODO V/f.....	58
CONFIGURAÇÃO DE DATA E HORÁRIO	58
BLOQUEIO DE ALTERAÇÃO DOS PARÂMETROS.....	58
FUNÇÕES DO MÓDULO DE MEMÓRIA FLASH.....	58
APENDICE 1 – ESPECIFICAÇÕES TÉCNICAS.....	59

SOBRE O GUIA

Este guia apresenta como instalar e colocar em funcionamento no modo de controle V/f o inversor de frequência CFW-11 das mecânicas A a G.

Para obter mais detalhes sobre o inversor de frequência CFW-11, consulte o manual do usuário e o manual de programação.

Também é possível operar o CFW-11 nos modos de controle: VVW, Controle Vetorial Sensorless e com Encoder para motores de indução e Controle Vetorial Sensorless e com Encoder para motores de ímã permanente (PM). Consulte o manual de programação.

Para obter os manuais em formato eletrônico e informações sobre outras funções, acessórios e condições de funcionamento, consulte o site WEG - www.weg.net.

INSTRUÇÕES DE SEGURANÇA

Leia totalmente este guia antes de instalar ou operar o inversor.

Somente pessoas com qualificação adequada e familiaridade com o inversor CFW-11 e equipamentos associados devem planejar ou implementar a instalação, partida, operação e manutenção deste equipamento. Estas pessoas devem seguir todas as instruções de segurança contidas neste manual e/ou definidas por normas locais.



PERIGO!

Os procedimentos recomendados neste aviso têm como objetivo proteger o usuário contra morte, ferimentos graves e danos materiais consideráveis. Sempre desconecte a alimentação geral antes de tocar em qualquer componente elétrico associado ao inversor.

Muitos componentes podem permanecer carregados com altas tensões e/ou em movimento (ventiladores), mesmo depois que a entrada de alimentação CA for desconectada ou desligada. Aguarde pelo menos 10 minutos para garantir a total descarga dos capacitores.

Sempre conecte a carcaça do equipamento ao terra de proteção (PE) no ponto adequado para isto.



NOTA!

Para os propósitos deste manual, pessoas qualificadas são aquelas treinadas de forma a estarem aptas para:

1. Instalar, aterrar, energizar e operar o CFW-11 de acordo com este manual e os procedimentos legais de segurança vigentes.
2. Utilizar os equipamentos de proteção de acordo com as normas estabelecidas.
3. Prestar serviços de primeiros socorros.



NOTA!

Inversores de frequência podem interferir em outros equipamentos eletrônicos. Siga as instruções de instalação para minimizar estes efeitos.

DESCRIÇÃO PRINCIPAL DO CFW-11

O inversor de frequência CFW-11 é um produto de alta performance com modelos que atendem a faixa de potência de 1 a 600cv (0.75 a 450 kW) em sete mecânicas diferentes e tensão de alimentação de 200 a 480 V. Foi desenvolvido para controle de velocidade e torque de motores de indução trifásicos e motores PM (de ímãs permanentes). A característica principal deste produto é a tecnologia "Vectrue" com os seguintes modos de controle: Controle Scalar (V/f), VVW, "Controle Vetorial Sensorless" e "Controle Vetorial com Encoder". Funções adicionais a destacar: "Optimal Braking" (frenagem ótima), "Self-Tuning" (auto-ajuste) e "Optimal Flux" (fluxo ótimo).

Para mais detalhes consulte o manual do usuário e o manual de programação do CFW-11.

RECEBIMENTO E ARMAZENAMENTO

Quando receber o produto verifique se:

A etiqueta de identificação do CFW-11 corresponde ao modelo comprado. Consulte o modelo e as características técnicas nas [tabelas A.1 e A.2](#).

Ocorreram danos durante o transporte. Caso seja detectado algum problema, contate imediatamente a transportadora.

Se o CFW-11 não for logo instalado, armazene-o em um lugar limpo e seco (temperatura entre -25 °C e 60 °C) com uma cobertura para evitar a entrada de poeira no interior do inversor.

INSTALAÇÃO MECÂNICA

CONDIÇÕES AMBIENTAIS

Evitar:

- Exposição direta a raios solares, chuva, umidade excessiva ou maresia.
- Gases ou líquidos explosivos ou corrosivos.
- Vibração excessiva.
- Poeira, partículas metálicas ou óleo suspenso no ar.
- Condições ambientais de acordo com as [tabelas A.1 e A.2](#).

CONSIDERAÇÕES GERAIS DE MONTAGEM

Consultar o peso do inversor nas [tabelas A.1 e A.2](#).

Instalar o inversor na posição vertical em uma superfície plana.

Dimensões externas e posição dos furos de fixação conforme a [figura 1](#).

Deixar no mínimo os espaços livres indicados na [figura 2](#) para permitir a circulação de ar para refrigeração.

Nota:

- Para os modelos das mecânicas A, B e C não é necessário espaçamento lateral entre os inversor se a tampa superior for removida.

Não colocar componentes sensíveis ao calor logo acima do inversor.

MONTAGEM EM PAINEL

Montagem em superfície:

Prever exaustão adequada, de modo que a temperatura interna do painel fique dentro da faixa permitida para as condições de operação do inversor.

A potência dissipada pelo inversor na condição nominal, conforme especificado na [tabela A.1 e A.2](#) na coluna "Potência dissipada em watts, montagem em superfície".

Na [tabela 1](#) é apresentado o mínimo de espaço necessário para a refrigeração do painel.

A posição e o diâmetro dos furos de fixação devem ser de acordo com a [figura 1](#).

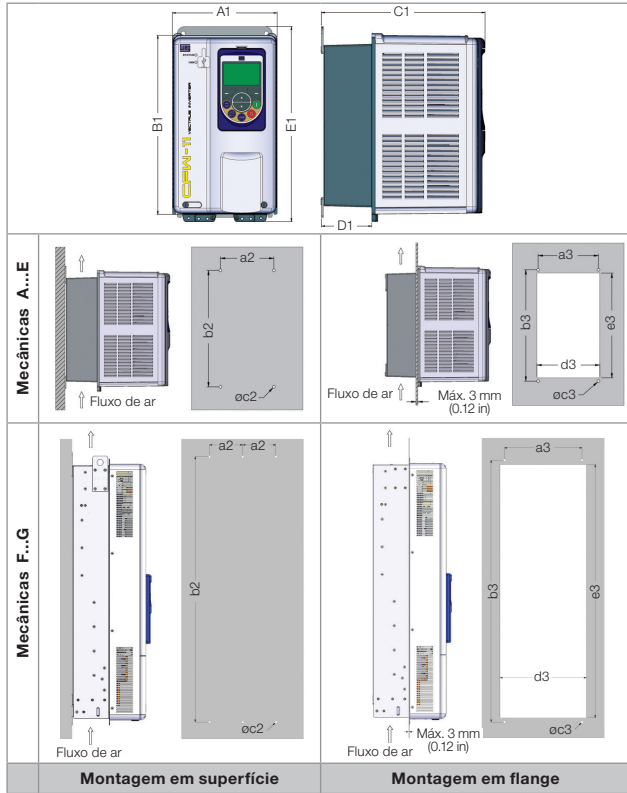

Modelo	A1	B1	C1	D1	E1	a2	b2	c2	a3	b3	c3	d3	e3
	mm (in)	mm (in)	mm (in)	mm (in)	mm (in)	mm (in)	mm (in)	M	mm (in)	mm (in)	M	mm (in)	mm (in)
Mec A	145 (5.71)	247 (9.73)	227 (8.94)	70 (2.75)	270 (10.63)	115 (4.53)	250 (9.85)	M5	130 (5.12)	240 (9.45)	M5	135 (5.32)	225 (8.86)
Mec B	190 (7.48)	293 (11.53)	227 (8.94)	71 (2.78)	316 (12.43)	150 (5.91)	300 (11.82)	M5	175 (6.89)	285 (11.23)	M5	179 (7.05)	271 (10.66)
Mec C	220 (8.67)	378 (14.88)	293 (11.53)	136 (5.36)	405 (15.95)	150 (5.91)	375 (14.77)	M6	195 (7.68)	365 (14.38)	M6	205 (8.08)	345 (13.59)
Mec D	300 (11.81)	504 (19.84)	305 (12.00)	135 (5.32)	550 (21.65)	200 (7.88)	525 (20.67)	M8	275 (10.83)	517 (20.36)	M8	285 (11.23)	485 (19.10)
Mec E	335 (13.19)	620 (24.41)	358 (14.09)	168 (6.61)	675 (25.57)	200 (7.88)	650 (25.59)	M8	275 (10.83)	635 (25.00)	M8	315 (12.40)	615 (24.21)
Mec F	430 (16.93)	1156 (45.51)	360 (14.17)	169 (6.65)	1234 (48.58)	150 (5.91)	1200 (47.24)	M10	350 (13.78)	1185 (46.65)	M10	391 (15.39)	1146 (45.12)
Mec G	535 (21.06)	1190 (46.85)	426 (16.77)	202 (7.95)	1264 (49.76)	200 (7.87)	1225 (48.23)	M10	400 (15.75)	1220 (48.03)	M10	495 (19.49)	1182 (46.53)

Tolerância das cotas d3 e e3: +1.0 mm (+0.039 in)
 Tolerâncias das demais cotas: ±1.0 mm (± 0.039 in)

Figura 1: Detalhes para a instalação mecânica

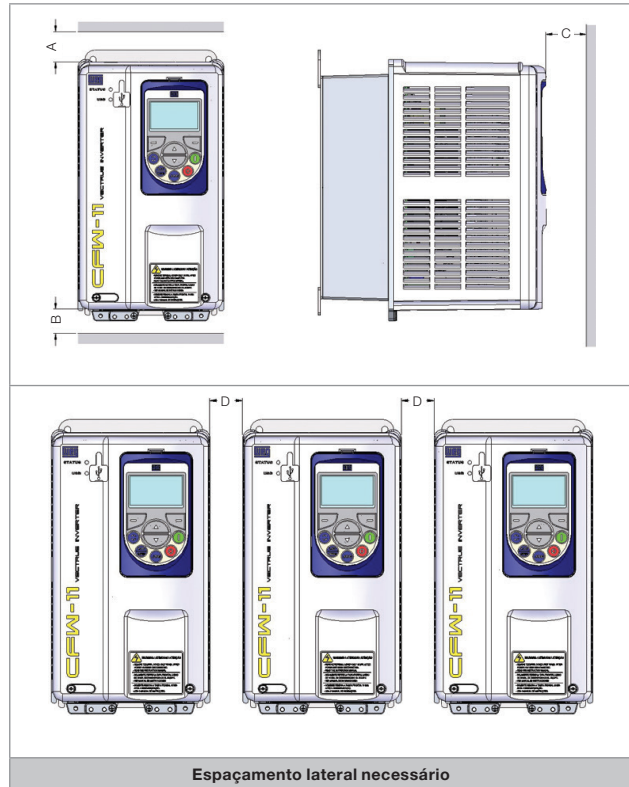

Modelo	A	B	C	D		
	mm (in)	mm (in)	mm (in)	mm (in)		
Mec A	25 (0.98)	25 (0.98)	10 (0.39)	30 (1.18)		
Mec B	40 (1.57)	45 (1.77)				
Mec C	110 (4.33)	130 (5.12)				
Mec D	100 (3.94)	130 (5.12)	20 (0.78)	40 (1.57)		
Mec E	0142 T2	150 (5.91)			250 (9.84)	80 (3.15)
	0180 T2	150 (5.91)				
	0211 T2	150 (5.91)				
	0105 T4	150 (5.91)				
Mec F	0142 T4	250 (9.84)	250 (9.84)	80 (3.15)		
	0180 T4	250 (9.84)				
Mec G	150 (5.91)	250 (9.84)				

Tolerância: ±1.0 mm (± 0.039 in)

Figura 2: Espaços livres para ventilação do inversor

Tabela 1: Fluxo de ar de ventilação do painel

Mecânica	Modelo	CFM	l/s	m³/min
A	Todos	18	8	0.5
B	Todos	42	20	1.2
C	Todos	96	45	2.7
D	Todos	132	62	3.7
E	CFW11 0142 T 2	138	65	3.9
	CFW11 0180 T 2			
	CFW11 0211 T 2	265	125	7.5
	CFW11 0105 T 4	138	65	3.9
	CFW11 0142 T 4			
	CFW11 0180 T 4	265	125	7.5
CFW11 0211 T 4				
F	CFW11 0242 T 4	250	118	7.1
	CFW11 0312 T 4	320	151	9.1
	CFW11 0370 T 4	380	180	10.1
	CFW11 0477 T 4	460	217	13
G	CFW11 0515 T 4	680	321	19.3
	CFW11 0601 T 4			
	CFW11 0720 T 4			

Montagem em flange:

A potência especificada nas [tabelas A.1 e A.2](#), na coluna "Potência dissipada em watts, montagem em flange" será dissipada no interior do painel. O restante será dissipado no duto de ventilação.

Os suportes de fixação e chapas para içamento do inversor deverão ser removidos e reposicionados nas mecânicas E, F e G, conforme apresentado nas [figuras 3 e 4](#).

A parte do inversor que fica para fora do painel possui grau de proteção IP54 para as mecânicas A a E e IP20 para as mecânicas F e G.

Prever vedação adequada do rasgo feito para a passagem do dissipador do inversor a fim de garantir o grau de proteção do painel. Exemplo: vedação com silicone.

Dimensões do rasgo na superfície de montagem, posição e diâmetro dos furos de fixação, conforme a [figura 1](#).



Figura 3: Reposicione os suportes de montagem nas mecânicas A a E. Nas mecânicas F e G os suportes devem ser removidos



Figura 4: Instalação das chapas para içamento do inversor das mecânicas E, F e G

Acesso aos bornes de Controle e Potência

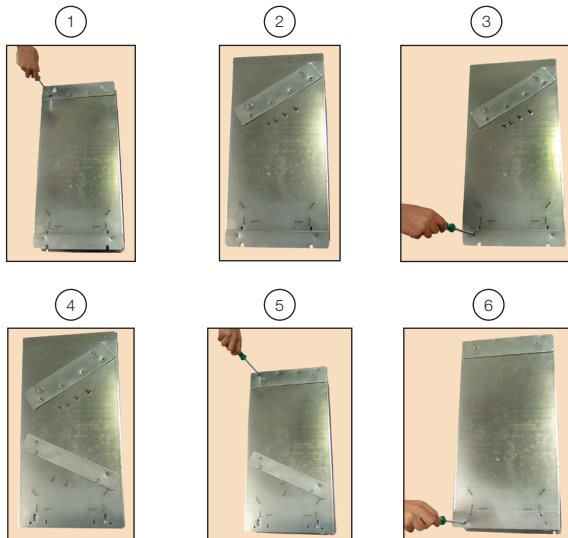
Nas mecânicas A, B e C, é necessário retirar a HMI e a tampa frontal para acessar os bornes de controle e de potência. Conforme a figura a seguir.

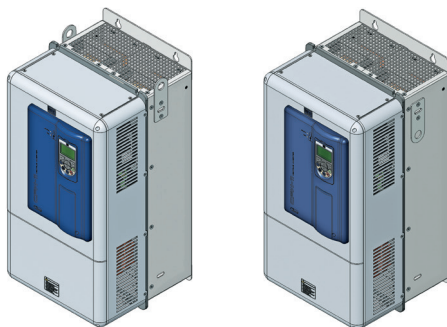

Figura 5: Remoção da HMI e tampa frontal



Figura 6: Remoção da HMI e da tampa do rack de controle das mecânicas D, E, F e G para acessar os terminais de controle

Para ter acesso aos bornes de potência, deve-se retirar a tampa frontal inferior nas mecânicas D a G, conforme apresentado na [figura 7](#).

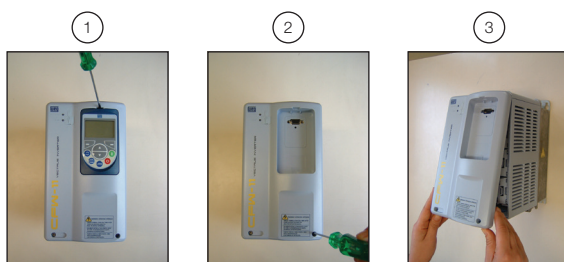

Figura 7: Remova a tampa frontal inferior para acessar os terminais de potência nas mecânicas D a G

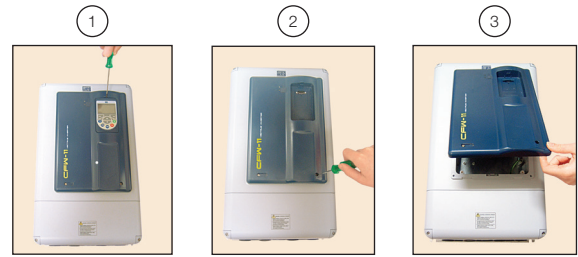
Quando não for necessário grau de proteção IP20 nem Nema1, a chapa de passagem dos cabos pode ser removida para facilitar a instalação elétrica nas mecânicas D e E.

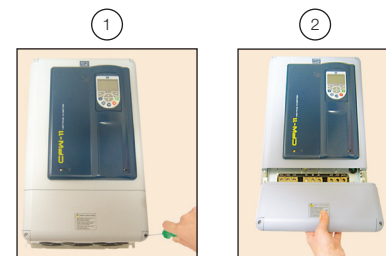

Figura 8: Retirada da chapa de passagem dos cabos

Nas mecânicas F e G é necessário retirar a chapa de proteção para a conexão dos cabos de potência (rede e motor), conforme [figura 9](#).

Neste caso o grau de proteção da parte inferior do inversor será reduzido.

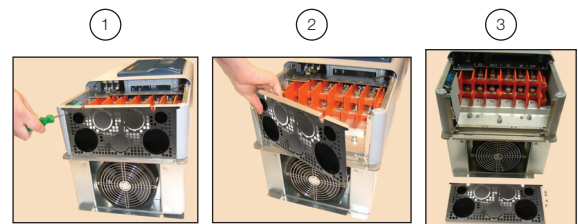

Figura 9: Retirada da chapa de passagem dos cabos nas mecânicas F e G

INSTALAÇÃO ELÉTRICA

PERIGO!
 Certifique-se que a rede de alimentação está desconectada, antes de iniciar a instalação

PERIGO!
 As informações a seguir têm a intenção de servir como guia para se obter uma instalação correta. Siga também as normas de instalação elétrica aplicáveis.

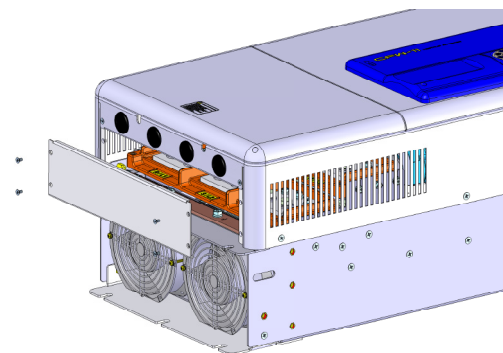
PERIGO!
 O inversor será danificado se a fonte de alimentação for conectada aos terminais de saída.

DIAGRAMAS DE CONEXÃO

Observação:
 As especificações técnicas incluindo a linha de fusíveis estão nas tabelas A.1 e A.2.

As especificações técnicas do resistor de frenagem e da corrente de frenagem encontram-se na tabela A.3.



Figura 10: Diagrama da conexão de potência para os modelos padrões das mecânicas A, B, C, D, E, F e G



Figura 11: Diagrama da conexão de potência das mecânicas F e G com hardware especial DC

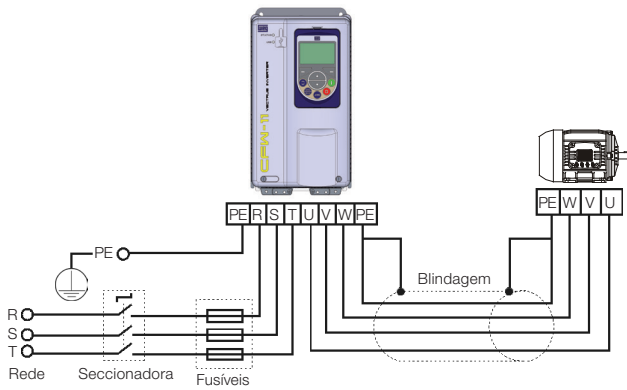

Figura 12: Diagrama de conexão do resistor de frenagem nas mecânicas A, B, C, D e E

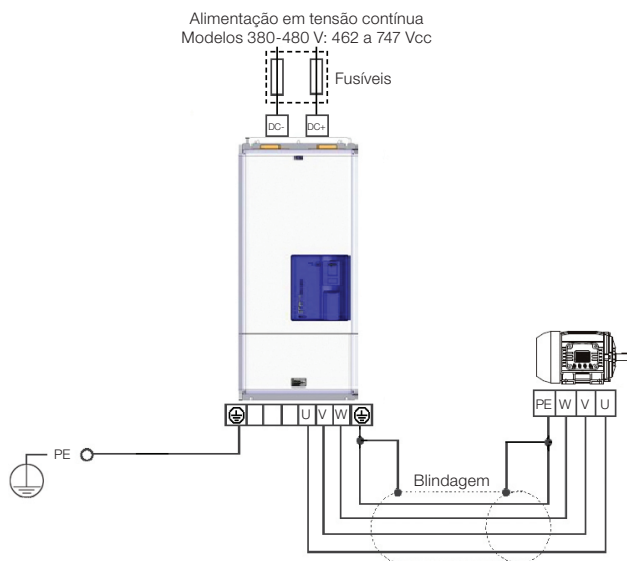

Figura 13: Diagrama da conexão de potência para os modelos padrões das mecânicas F e G com resistor de frenagem

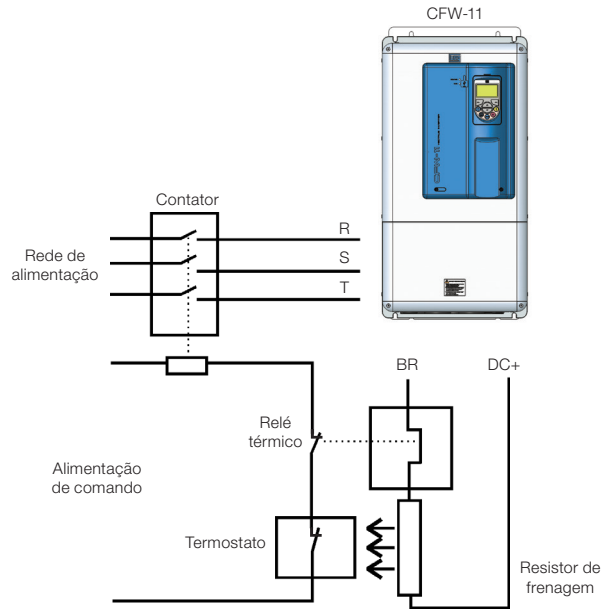

Figura 14 (a): Terminais de potência e aterramento das mecânicas A a C

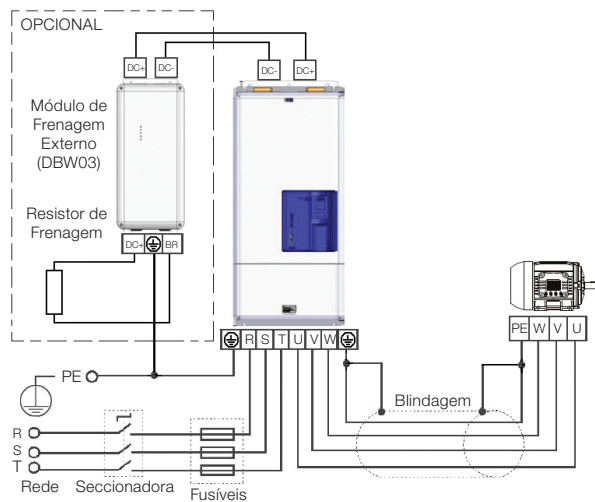

Aterramento
(b) Mecânica D

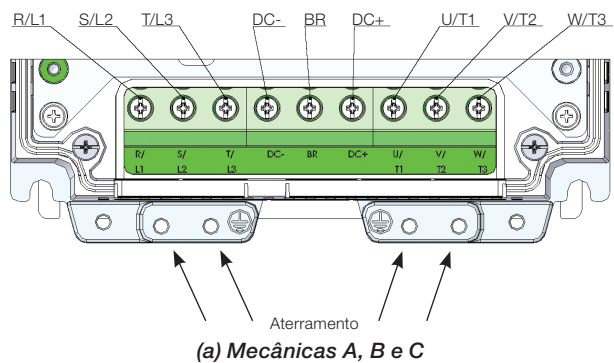
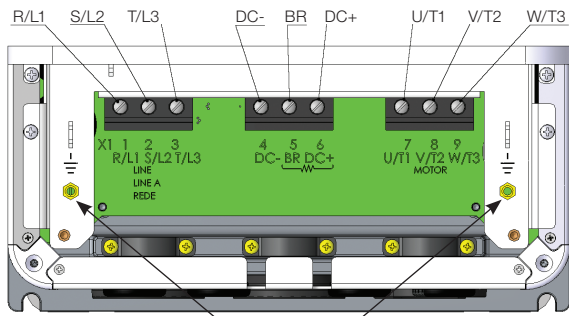

Aterramento
(4xM8, 4xM5)
(c) Mecânica E

Figura 14 (b) e (c): Terminais de potência e aterramento das mecânicas D e E

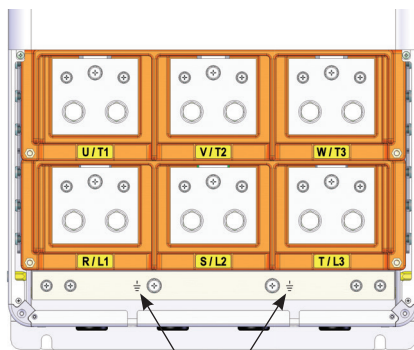

Aterramento
(a) Padrão

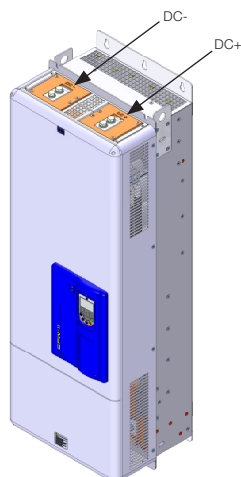

(b) Hardware especial DC

Figura 15 (a) e (b): Terminais de potência e aterramento das mecânicas F e G



Figura 16: Conexão do módulo de frenagem reostática nos modelos padrão das mecânicas F e G

INFORMAÇÕES SOBRE CIRCUITOS E DISPOSITIVOS

- A rede que alimenta o inversor deve ter o neutro solidamente aterrado. Em redes IT alguns componentes devem ser desconectados conforme apresentado nas figuras 17 a 19.
- Prever um dispositivo para seccionamento da alimentação do inversor. Este deve seccionar a rede de alimentação para o inversor quando necessário (por exemplo: durante trabalhos de manutenção).
- O fusível a ser utilizado na entrada deve ser do tipo UR (Ultra-Rápido) com I^2t igual ou menor que o indicado nas tabelas A.1 e A.2 (considerar valor de extinção de corrente (e não fusão) a frio), para operação dos diodos retificadores de entrada do inversor e da fiação.
- Para conformidade com norma UL, utilizar fusíveis classe J na alimentação do inversor com corrente não maior que os valores das tabelas A.1 e A.2.
- Opcionalmente, podem ser utilizados na entrada fusíveis de ação retardada, dimensionados para 1.2 x corrente nominal de entrada do inversor. Neste caso, a instalação fica protegida contra curto-circuito, exceto os diodos da ponte retificadora na entrada do inversor. Isto pode causar danos maiores ao inversor no caso de algum componente interno falhar.
- O CFW-11 é indicado para uso em um circuito capaz de fornecer não mais de que 100.000 Arms simétricos (230 V / 480 V).
- Recomenda-se usar cabo blindado do motor conforme IEC 60034-25.
- Mantenha os cabos do motor no mínimo 25 cm de distância dos demais cabos (cabos de sinal, cabos de sensores, cabos de comando, etc.).

REDE IT

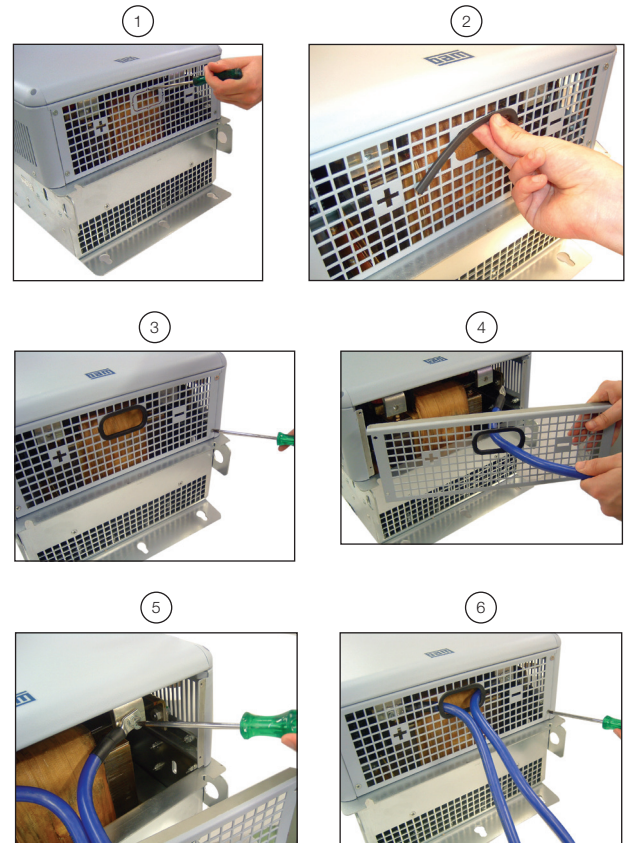
Quando o neutro não está aterrado, ou o aterramento é feito via um resistor de valor ôhmico alto ou em redes delta aterrado (“delta corner earth”).



Figura 17 (a) a (d): Localização dos parafusos de aterramento – Remova-os para rede IT nas mecânicas A...D



(a) Localização do cartão

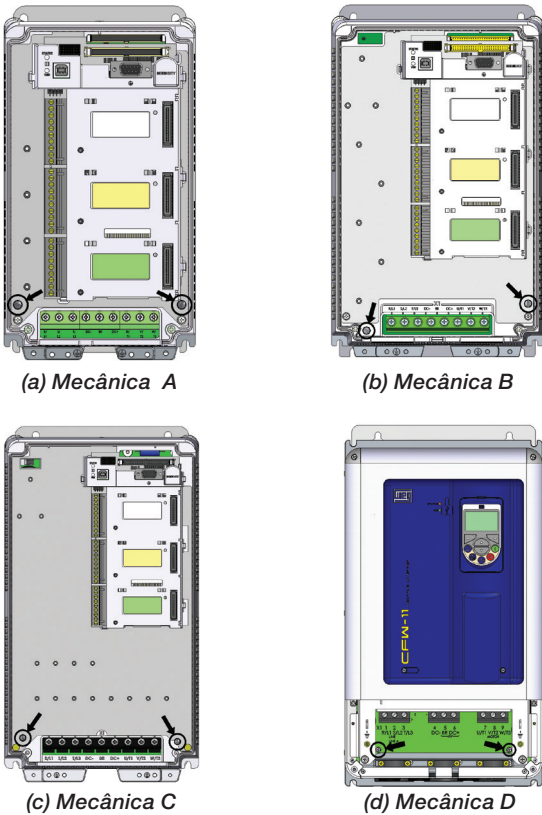
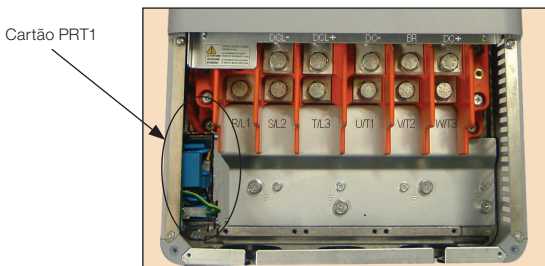
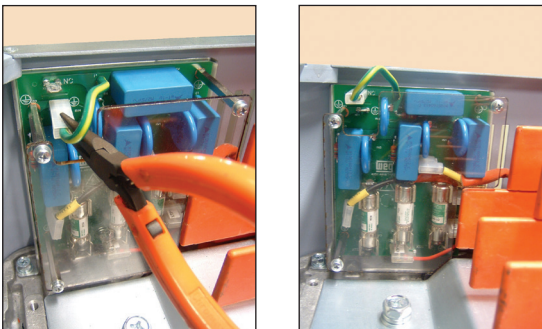

(b) Posição inicial

(c) Posição final (IT)

Figura 18 (a) a (c): Localização do terminal no cartão PRT1 – Alterar a posição para rede IT da mecânica E

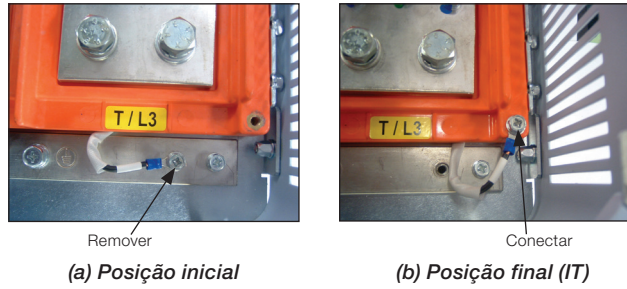

(a) Posição inicial

(b) Posição final (IT)

Figura 19 (a) e (b): Localização do terminal no cartão PRT1 - Alterar a posição para rede IT nas mecânicas F e G

CONEXÕES DE ATERRAMENTO



PERIGO!

O aterramento do inversor deve ser conectado ao terra de proteção. Caso existam normas locais que exijam bitolas diferentes, estas devem ser seguidas. Conecte os pontos de aterramento do inversor a uma haste de aterramento específica, ou ao ponto de aterramento específico ou ainda ao ponto de aterramento geral (resistência $\leq 10 \Omega$). Para compatibilidade com a norma IEC 61800-5-1 utilize no mínimo um cabo de cobre de 10 mm² para conexão do inversor ao terra de proteção, já que a corrente de fuga é maior que 3.5 mAca.



ATENÇÃO!

O condutor da rede que alimenta o inversor deve ser solidamente aterrado, porém, o mesmo não deve ser utilizado para aterramento do inversor.



Figura 20: Conexões de aterramento para mais de um inversor

PORTUGUÊS

CONEXÕES DE CONTROLE

As conexões de controle (entradas / saídas analógicas, entradas / saídas digitais) devem ser feitas no conector XC1 do Cartão Eletrônico de Controle CC11.

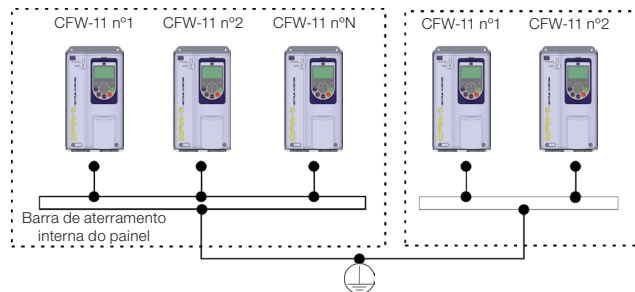
	Conector XC1	Função Padrão de Fábrica
	1	REF+ Referência positiva para potenciômetro (5.4 V ± 5 %).
	2	AI1+ Entrada analógica 1: Referência de velocidade (remota).
	3	AI1-
	4	REF- Referência negativa para potenciômetro (-4.7 V ± 5 %).
	5	AI2+ Entrada analógica 2: Sem Função
	6	AI2-
	7	AO1 Saída analógica 1: Velocidade.
	8	AGND (24 V) Referência 0 V para saídas analógicas.
	9	AO2 Saída analógica 2: Corrente do motor.
	10	AGND (24 V) Referência 0 V para saídas analógicas.
	11	DGND* Referência 0 V da fonte de 24 Vcc.
	12	COM Ponto comum das entradas digitais.
	13	24 Vcc Fonte de alimentação 24 Vcc.
	14	COM Ponto comum das entradas digitais.
	15	DI1 Entrada digital 1: Gira/Para.
	16	DI2 Entrada digital 2: Sentido de giro (remoto).
	17	DI3 Entrada digital 3: Sem função.
	18	DI4 Entrada digital 4: Sem função.
	19	DI5 Entrada digital 5: Jog (remoto).
	20	DI6 Entrada digital 6: 2º Rampa.
	21	NF1 Saída digital 1 DO1 (RL1): Sem falha
	22	C1
23	NA1	
	24	NF2 Saída digital 2 DO2 (RL2): N > N _x - Velocidade > P0288.
	25	C2
	26	NA2
	27	NF3 Saída digital 3 DO3 (RL3): N* > N _x - Referência de velocidade > P0288.
	28	C3
	29	NA3

Figura 21: Sinais no conector XC1 – Entradas digitais como ativo alto



NOTA!

Para utilizar as entradas digitais como ativo baixo é necessário remover o jumper que liga XC1:11 e 12 e passar para XC1:12 e 13 e conectar o ponto comum que liga as DIP Switches DI1 a DI6 do conector XC1:11, ao invés de XC1:13.

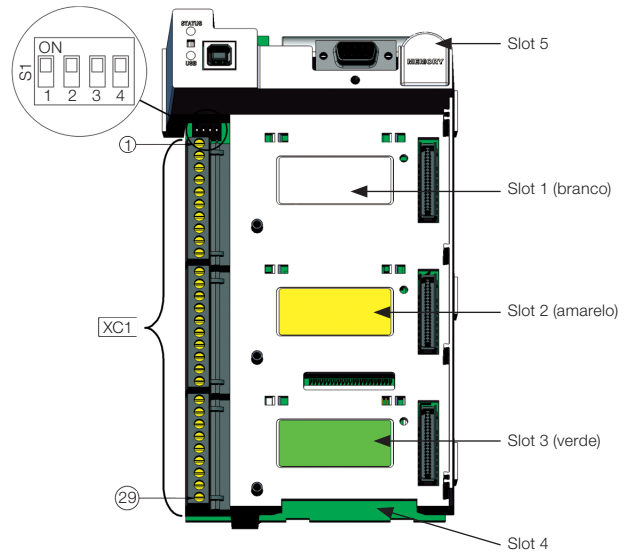

Sinal	Função Padrão de Fábrica	Elemento de Ajuste	Seleção	Ajuste de Fábrica
AI1	Referência de Velocidade (remota)	S1.4	OFF: 0 a 10 V (padrão de fábrica) ON: 4 a 20 mA / 0 a 20 mA	OFF
AI2	Sem Função	S1.3	OFF: 0 a ±10 V (padrão de fábrica) ON: 4 a 20 mA / 0 a 20 mA	OFF
AO1	Velocidade	S1.1	OFF: 4 a 20 mA / 0 a 20 mA ON: 0 a 10 V (padrão de fábrica)	ON
AO2	Corrente do motor	S1.2	OFF: 4 a 20 mA / 0 a 20 mA ON: 0 a 10 V (padrão de fábrica)	ON

Figura 22: Configuração das chaves para seleção do tipo de sinal nas entradas e saídas analógicas



NOTA!

Para obter mais informações referente a função Parada de Segurança (STO), consulte o Guia de Instalação, Configuração e Operação.

Conexões Típicas de Controle

Acionamento 1 - Função Gira/Para com comando via HMI (Modo Local).

Com a programação padrão de fábrica é possível a operação do inversor no modo local. Recomenda-se este modo de operação para usuários que estejam utilizando o inversor pela primeira vez, como forma de aprendizado, sem conexões adicionais no controle.

Acionamento 2 - Função Gira/Para com comando a dois fios (Modo Remoto).

Válido para programação padrão de fábrica e inversor operando no modo remoto.

No padrão de fábrica, a seleção do modo de operação (local/remoto) é feita pela tecla (default local). Para passar a programação default da tecla para remoto fazer P0220=3.

Acionamento 3 - Função Start/Stop com comando a três fios.

Habilitação da função Gira/Para com comando a 3 fios.

Parâmetros a programar:

Programar DI3 para START P0265=6

Programar DI4 para STOP P0266=7

Programar P0224=1 (DIx) caso deseje o comando a 3 fios em modo Local.

Programar P0227=1 (DIx) caso deseje o comando a 3 fios em modo Remoto.

Programar Sentido de Giro pela DI2.

Programar P0223=4 para Modo Local ou P0226=4 para Modo Remoto.

S1 e S2 são botoeiras pulsantes liga (contato NA) e desliga (contato NF) respectivamente.

A referência de velocidade pode ser via entrada analógica AI (como no Acionamento 2), via HMI (como no Acionamento 1) ou outra fonte.



Figura 23: Conexões em XC1 para acionamento 2



Figura 24: Conexões em XC1 para acionamento 3

Acionamento 4 - Avanço/Retorno.

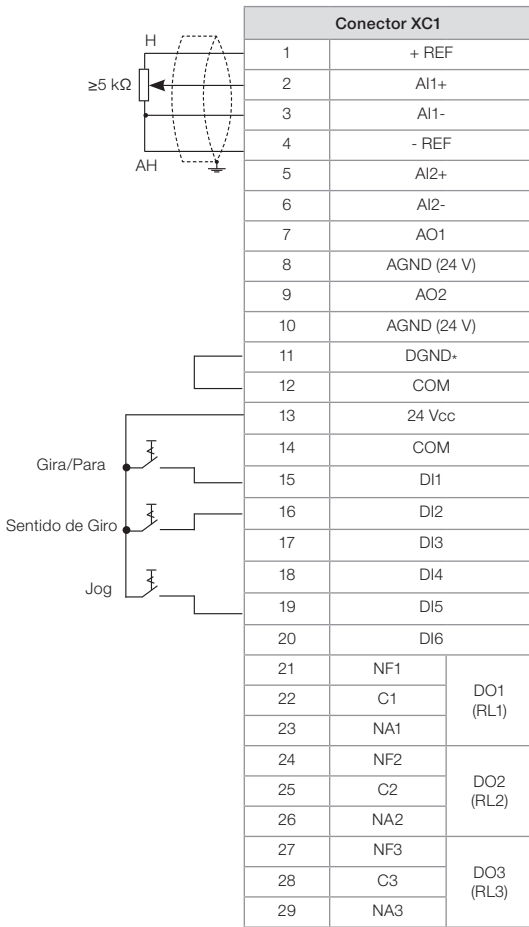
Habilitação da função Avanço/Retorno.

Parâmetros a programar:

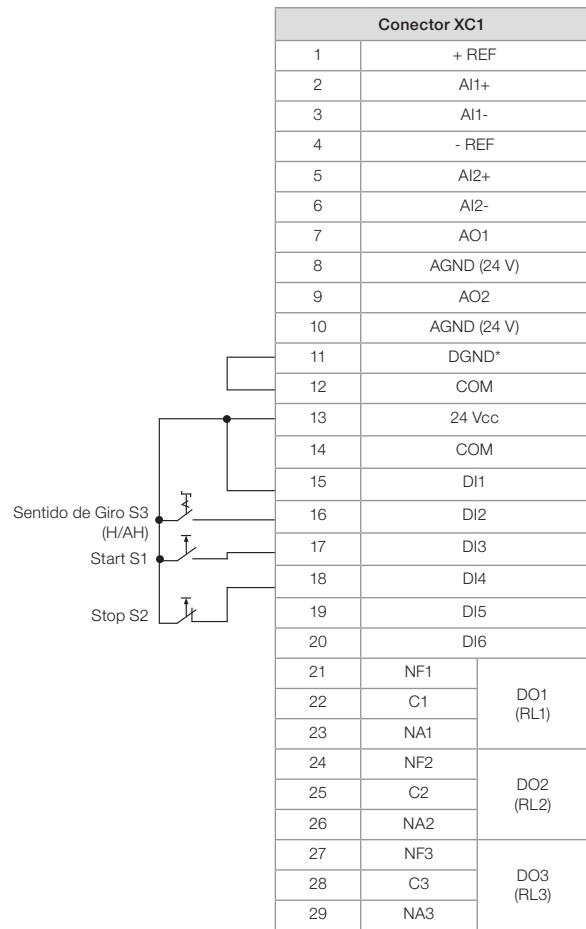
Programar DI3 para AVANÇO P0265=4

Programar DI4 para RETORNO P0266=5

Quando a função Avanço/Retorno for programada, a mesma estará ativa, tanto em modo local como remoto. Ao mesmo tempo as teclas

e ficam sempre inativas (mesmo que P0224=0 ou P0227=0).

O sentido de giro é definido pelas entradas avanço e retorno.

Rotação horária para avanço e anti-horária para retorno.

A referência de velocidade pode ser proveniente de qualquer fonte (como no Acionamento 3).



Figura 25: Conexões em XC1 para Acionamento 4

INSTALAÇÕES DE ACORDO COM A DIRETIVA EUROPEIA DE COMPATIBILIDADE ELETROMAGNÉTICA

Os inversores nas mecânicas A a D com a opção FA (CFW11XXXXXXOFA) e nos inversores padrão das outras mecânicas possui filtro RFI interno para redução da interferência eletromagnética. Estes inversores, quando corretamente instalados, atendem os requisitos da diretiva de compatibilidade eletromagnética “EMC Directive 2004/108/EC”.

ATENÇÃO!

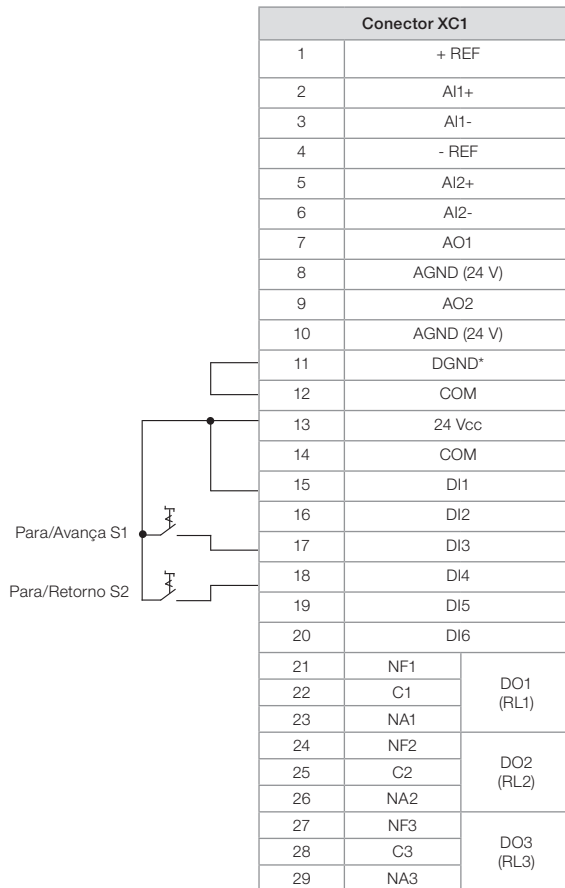
Para utilizar modelos com filtro RFI interno em redes IT, siga as instruções descritas nas [figuras 17 a 19](#).

Instalação Conforme

Para a instalação conforme, utilize:

1. Inversores nas mecânicas A a D: com a opção filtro RFI interno CFW11XXXXXXOFA e outros modelos padrão.
2. Cabos de saída (cabos do motor) blindados e com a blindagem conectada em ambos os lados, motor e inversor, com conexão de baixa impedância para alta frequência. Comprimento máximo do cabo do motor e níveis de emissão conduzida e radiada de acordo com as [tabelas 2 e 3](#). Se for desejado nível de emissão inferior e/ou maior comprimento de cabo do motor, utilizar filtro RFI externo na entrada do inversor. Para mais informações (referência comercial do filtro RFI, comprimento do cabo do motor e níveis de emissão) consulte as [tabelas 2 e 3](#).
3. Cabos de controle blindado.
4. Inversor solidamente aterrado.

Tabela 2: Níveis de emissão conduzida e radiada nas mecânicas A a D

Modelo do Inversor (Com Filtro RFI Interno)	Sem filtro RFI externo			Com Filtro RFI Externo				
	Emissão Conduzida - Comprimento Máximo do Cabo do Motor	Emissão Radiada	Categoria (Não é Necessário Usar Painel Metálico)	Referência Comercial do Filtro RFI Externo (Fabricante: EPCOS)		Emissão Conduzida - Comprimento Máximo do Cabo do Motor	Emissão Radiada - Categoria	Categoria
				Categoria C3	Categoria C2			
CFW11 0006 S 2 O FA	100 m	7 m	C2	B84142-A16-R122	75 m	50 m	C2	C2
				B84142-B16-R	100 m	100 m		
CFW11 0007 T 2 O FA	100 m	5 m	C2	B84143-G8-R110	100 m	-	C2	C2
				B84143-A8-R105	50 m	50 m		
CFW11 0007 S 2 O FA	100 m	7 m	C2	B84142-A16-R122	75 m	50 m	C2	C2
				B84142-B16-R	100 m	100 m		
CFW11 0010 S 2 O FA	100 m	7 m	C2	B84142-A30-R122	75 m	50 m	C2	C2
				B84142-B25-R	100 m	100 m		
CFW11 0010 T 2 O FA	100 m	5 m	C2	B84143-G20-R110	100 m	-	C2	C2
				B84143-A16-R105	50 m	50 m		
CFW11 0013 T 2 O FA	100 m	5 m	C2	B84143-G20-R110	100 m	-	C2	C2
				B84143-A16-R105	50 m	50 m		
CFW11 0016 T 2 O FA	100 m	5 m	C2	B84143-G20-R110	100 m	-	C2	C2
				B84143-A25-R105	50 m	50 m		
CFW11 0024 T 2 O FA	100 m	Não	C2	B84143-A36-R105	100 m	100 m	C2	C2
CFW11 0028 T 2 O FA	100 m	Não	C2	B84143-A36-R105	100 m	100 m	C2	C2
CFW11 0033 T 2 O FA	100 m	Não	C2	B84143-A50-R105	100 m	100 m	C2	C2
CFW11 0045 T 2 O FA	100 m	Não	C3	B84143-A50-R105	100 m	100 m	C3	C2
CFW11 0054 T 2 O FA	100 m	Não	C3	B84143-A66-R105	100 m	100 m	C3	C2
CFW11 0070 T 2 O FA	100 m	Não	C3	B84143-A90-R105	100 m	100 m	C3	C2
CFW11 0086 T 2 O FA	100 m	Não	C3	B84143-A120-R105	100 m	100 m	C3	C2
CFW11 0105 T 2 O FA	100 m	Não	C3	B84143-A120-R105	100 m	100 m	C3	C2
CFW11 0003 T 4 O FA	100 m	5 m	C2	B84143-G8-R110	100 m	-	C2	C2
				B84143-A8-R105	50 m	50 m		
CFW11 0005 T 4 O FA	100 m	5 m	C2	B84143-G8-R110	100 m	-	C2	C2
				B84143-A8-R105	50 m	50 m		
CFW11 0007 T 4 O FA	100 m	5 m	C2	B84143-G8-R110	100 m	-	C2	C2
				B84143-A8-R105	50 m	50 m		
CFW11 0010 T 4 O FA	100 m	5 m	C2	B84143-G20-R110	100 m	-	C2	C2
				B84143-A16-R105	50 m	50 m		
CFW11 0013 T 4 O FA	100 m	5 m	C2	B84143-G20-R110	100 m	-	C2	C2
				B84143-A16-R105	50 m	50 m		
CFW11 0017 T 4 O FA	100 m	Não	C2	B84143-A25-R105	100 m	100 m	C2	C2
CFW11 0024 T 4 O FA	100 m	Não	C2	B84143-A36-R105	100 m	100 m	C2	C2
CFW11 0031 T 4 O FA	100 m	Não	C2	B84143-A36-R105	100 m	100 m	C2	C2
CFW11 0038 T 4 O FA	100 m	Não	C3	B84143-A50-R105	100 m	100 m	C3	C2
CFW11 0045 T 4 O FA	100 m	Não	C3	B84143-A50-R105	100 m	100 m	C3	C2
CFW11 0058 T 4 O FA	100 m	Não	C3	B84143-A66-R105	100 m	100 m	C3	C2
CFW11 0070 T 4 O FA	100 m	Não	C3	B84143-A90-R105	100 m	100 m	C3	C2
CFW11 0088 T 4 O FA	100 m	Não	C3	B84143-A120-R105	100 m	100 m	C3	C2

Tabela 3: Níveis de emissão conduzida e radiada nas mecânicas E, F e G

Modelo do Inversor (Com Filtro RFI Interno)	Mecânica	Sem filtro RFI externo		Com Filtro RFI Externo		
		Emissão Conduzida - Comprimento Máximo do Cabo do Motor	Emissão Radiada	Referência Comercial do Filtro RFI Externo (Fabricante: EPCOS)	Emissão Conduzida - Comprimento Máximo do Cabo do Motor	Emissão Radiada - Categoria
CFW11 0142 T2	E	100 m (328.10 ft)	C2	B84143-B0150-S020	100 m (328.10 ft)	C2
CFW11 0180 T2		100 m (328.10 ft)	C2	B84143-B0180-S020 (1)	100 m (328.10 ft)	C2
CFW11 0211 T2		100 m (328.10 ft)	C2	B84143-B0250-S020 (2)	100 m (328.10 ft)	C2
CFW11 0105 T4		100 m (328.10 ft)	C2	B84143-B0150-S020	100 m (328.10 ft)	C2
CFW11 0142 T4		100 m (328.10 ft)	C2	B84143-B0150-S020	100 m (328.10 ft)	C2
CFW11 0180 T4		100 m (328.10 ft)	C2	B84143-B0180-S020 (1)	100 m (328.10 ft)	C2
CFW11 0211 T4		100 m (328.10 ft)	C2	B84143-B0250-S020 (2)	100 m (328.10 ft)	C2
CFW11 0242 T4		100 m (328.10 ft)	C3 (3)	B84143-B0250-S021	100 m (328.10 ft) (4)	C3
CFW11 0312 T4		100 m (328.10 ft)	C3 (3)	B84143-B01420-S021	100 m (328.10 ft) (4)	C3
CFW11 0370 T4		100 m (328.10 ft)	C3 (3)	B84143-B0400-S021	100 m (328.10 ft) (4)	C3
CFW11 0477 T4	100 m (328.10 ft)	C3 (3)	B84143-B0600-S021	100 m (328.10 ft) (4)	C3	
CFW11 0515 T4	G	100 m (328.10 ft)	C3 (3)	B84143-B0600-S021	100 m (328.10 ft) (4)	C3
CFW11 0601 T4		100 m (328.10 ft)	C3 (3)	B84143-B0600-S021	100 m (328.10 ft) (4)	C3
CFW11 0720 T4		100 m (328.10 ft)	C3 (3)	B84143-B1000-S021	100 m (328.10 ft) (4)	C3

Notas da tabela 3:

- (1) Para temperatura ambiente ao redor do inversor/filtro maior que 40 °C (104 °F) e corrente de saída continua maior que 172 Arms, é necessário utilizar filtro B84143B0250S020.
- (2) Para temperatura ambiente ao redor do inversor/filtro de 40 °C (104 °F) e aplicações com regime de sobrecarga pesada (HD, corrente de saída < 180 Arms), é possível utilizar o filtro B84143B0180S020.
- (3) Com o transformador de corrente nos três cabos de alimentação. Exemplo: TDK PN: PC40 UU120x160x20.
- (4) Frequência mínima de operação 2,5 Hz.

INTERFACE HOMEM-MÁQUINA- HMI-CFW-11

Soft key esquerda: função definida pelo texto do display logo acima.

Soft key direita: função definida pelo texto no display logo acima.

- Incrementa conteúdo do parâmetro.
- Diminui velocidade.
- Seleciona próximo grupo da lista Grupo de Parâmetro.

1. Decrementa conteúdo do parâmetro.
2. Diminui velocidade.
3. Seleciona próximo grupo da lista Grupo de Parâmetro.

Controle do sentido de rotação do motor.
Ativa quando: P0223=2 ou 3 em LOC e/ou P0226=2 ou 3 em REM.

Acelera o motor com tempo determinado pela rampa de aceleração.
Ativa quando: P0224=0 em LOC e/ou P0227=0 em REM.

Seleciona modo LOCAL ou REMOTO.
Ativa quando: P0220=2 ou 3.

Desacelera o motor com tempo determinado pela rampa de desaceleração, até sua parada.
Ativa quando: P0224=0 em LOC e/ou P0227=0 em REM.

Acelera motor com tempo determinado pela rampa de aceleração até a velocidade definida por P0122. Mantém motor nesta velocidade enquanto pressionada. Ao ser liberada desacelera motor com tempo determinado pela rampa de desaceleração, até a sua parada.
Ativa quando todas as condições abaixo forem satisfeitas:
1. Gira/Para=Para;
2. Habilidade Geral=Ativo;
3. P0225=1 em LOC e/ou P0228=1 em REM.

Figura 26: Teclas e funções da HMI



Figura 27: Display da HMI e exemplos da função padrão de fábrica (modo monitoração)



Figura 28: Localização da tampa de acesso à bateria

Notas da HMI:

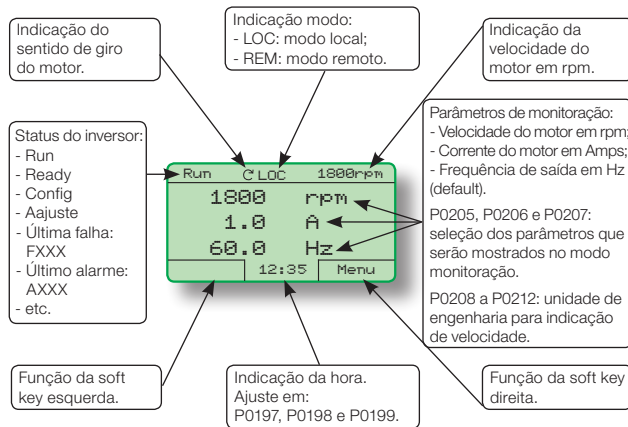
- A HMI pode ser conectada com o inversor energizado.
- Outros modos de visualização podem ser programados, tais como gráfico de barras e caracteres maiores, através de ajuste dos parâmetros P0205-207 e P0208-212.
- A bateria é usada apenas para manter o funcionamento do relógio interno quando o inversor for desenergizado. Se a bateria estiver completamente descarregada ou se não estiver instalada na HMI, a hora exibida pelo relógio será inválida e ocorrerá a indicação de "A181 - Relógio de tempo inválido", cada vez que o inversor for energizado.
- Ao final da vida útil, não depositar a bateria em lixo comum e sim em local próprio para descarte de baterias.

ESTRUTURA DE PARÂMETROS

Quando pressionada a tecla soft key direita no modo monitoração ("MENU") é mostrado no display os grupos de parâmetros. O número e o nome dos grupos podem mudar dependendo da versão de software utilizada.

START-UP

PERIGO!
O inversor será danificado caso a potência da alimentação de entrada for conectada aos terminais de saída.

ANTES DA ENERGIZAÇÃO

- 1) Verifique se as conexões de potência, aterramento e de controle estão corretas e firmes.
- 2) Retire todos os restos de materiais do interior do inversor ou acionamento.
- 3) Verifique as conexões do motor e se a corrente e tensão do motor estão de acordo com o inversor.
- 4) Desacople mecanicamente o motor da carga:
Se o motor não pode ser desacoplado, tenha certeza que o giro em qualquer direção (horário ou anti-horário) não causará danos à máquina ou risco de acidentes.
- 5) Feche as tampas do inversor ou acionamento.
- 6) Meça a tensão da rede e verifique se está dentro da faixa permitida.
- 7) Energize a entrada:
Feche a seccionadora de entrada.
- 8) Verifique o sucesso da energização:
O display deve mostrar na tela o modo monitoração padrão e o led de estado deve acender e permanecer aceso com a cor verde.

PARTIDA NO MODO V/f

A colocação em funcionamento no modo V/f é explicada de forma simples em 3 passos, usando as facilidades de programação com os grupos de parâmetros existentes **Start-Up Orientado** e **Aplicação Básica**.

1) Ajuste da Senha em P0000

Seq.	Ação/Resultado	Indicação no display
1	- Modo Monitoração. - Pressione "Menu" ("soft key" direita).	
2	- O grupo "00 TODOS PARÂMETROS" já está selecionado. - Pressione "Selec." .	
3	- O parâmetro "Acesso aos Parâmetros P0000: 0" já está selecionado. - Pressione "Selec." .	
4	- Para ajustar a senha, pressione até o número 5 aparecer no display.	
5	- Quando o número 5 aparecer, pressione "Salvar" .	
6	- Se o ajuste foi corretamente realizado, o display deve mostrar "Acesso aos Parâmetros P0000: 5" . - Pressione "Sair" (soft key esquerda).	
7	- Pressione "Sair" .	
8	- O display volta para o Modo Monitoração.	

Figura 29: Procedimentos para permitir a modificação dos parâmetros através de P0000

2) Start-up Orientado

Para facilitar o ajuste do inversor existe um grupo de parâmetros chamado de Start-up Orientado. Dentro deste grupo existe o parâmetro P0317, através do qual se pode entrar na rotina de Start-up Orientado.

A rotina de Start-Up Orientado apresenta na HMI os principais parâmetros em uma sequência lógica. Os parâmetros mínimos necessários para o funcionamento adequado são ajustados. Informações como tensão de alimentação e dados de placa do motor são informadas.

Para entrar na rotina de Start-up Orientado siga a sequência primeiramente alterando P0317=1 e, após, ajustando os outros parâmetros a medida que estes vão sendo mostrados no display da HMI.

O ajuste dos parâmetros apresentados neste modo de funcionamento resulta na modificação automática do conteúdo de outros parâmetros e/ou variáveis internas do inversor.

Durante a rotina de Start-Up Orientado será indicado o estado "Config" (Configuração) no canto superior esquerdo da HMI.

3) Ajuste dos Parâmetros da Aplicação Básica

Após executada a rotina de Start-up Orientado e ajustado corretamente os parâmetros, o inversor está pronto para operar no modo V/f.

O grupo Aplicação Básica tem os parâmetros de aplicação mais comuns.

CONFIGURAÇÃO DE DATA E HORÁRIO

Acesse o grupo HMI e ajuste: dia (P0194), mês (P0195), ano (P0196), hora (P0197), minutos (P0198) e segundos (P0199).

BLOQUEIO DE ALTERAÇÃO DOS PARÂMETROS

Caso se queira evitar a alteração de parâmetros por pessoas não autorizadas, alterar o conteúdo de P0000 para um valor diferente de 5.

FUNÇÕES DO MÓDULO DE MEMÓRIA FLASH

- Armazena imagem dos parâmetros do inversor.
- Permite transferir parâmetros armazenados no módulo de memória FLASH para o inversor.
- Permite transferir firmware armazenado no módulo de memória FLASH para o inversor.
- Armazena programa gerado pelo SoftPLC.

Sempre que o inversor é energizado, transfere este programa para a memória RAM, localizada no cartão de controle do inversor, e executa o programa.

Para mais detalhes consulte o manual de programação e o manual SoftPLC do CFW-11.

APENDICE 1 – ESPECIFICAÇÕES TÉCNICAS

Tabela A.1: Especificações técnicas dos modelos das mecânicas A a D

Modelo	Mecânica	Alimentação	Uso em Regime de Sobrecarga Normal (ND)						Uso em Regime de Sobrecarga Pesada (HD)						Temperatura Ambiente ao Redor do Inversor [°C (°F)]	Frenagem Reostática	Grau de Proteção do Gabinete	Filtro RFI	Parada de Segurança	Alimentação Externa da Eletrônica em 24 Vcc															
			Corrente de Sobrecarga [Arms]	1 min	3 s	Frequência de Chaveamento Nominal [kHz]	Motor Máximo [HP/kW]	Corrente de Entrada Nominal [Arms]	Potência Dissipada [W]	Corrente de Saída Nominal [Arms]	1 min	3 s	Frequência de Chaveamento Nominal [kHz]	Motor Máximo [HP/kW]							Corrente de Entrada Nominal [Arms]	Potência Dissipada [W]	Montagem em Superfície	Montagem em Flange	Peso [kg (lb)]	Fusível [A] conforme Norma Européia IEC	I ² t do fusível [A ² s] @ 25 °C								
CFW11 0006 B 2	A	1ø/3ø	6	6.6	9	5	1.5/1.1	12.3/6	6	7.5	10	5	1.5/1.1	10.3/5	120	25	5.7/12.6	15	420	5.7/12.6	15	420	5.7/12.6	15	420	Possui	Nema 1 (kit eletroduto para a mecânica A)	Possui	Sim	Sim					
CFW11 0006 S 2 O FA		1ø	6	6.6	9	5	1.5/1.1	12.3	6	7.5	10	5	1.5/1.1	10.3	130	25	5.7/12.6	15	420	5.7/12.6	15	420	5.7/12.6	15	420						Possui	Nema 1 (kit eletroduto para a mecânica A)	Possui	Sim	Sim
CFW11 0007 T 2		3ø	7	7.7	10.5	5	2/1.5	7	5.5	8.25	11	5	1.5/1.1	5.5	140	25	5.7/12.6	15	420	5.7/12.6	15	420	5.7/12.6	15	420										
CFW11 0007 B 2	1ø/3ø	7	7.7	10.5	5	2/1.5	14.4/7	7	10.5	14	5	2/1.5	14.4/7	140	25	6.1/13.4	20(1ø)/15(3ø)	420	6.1/13.4	20(1ø)/15(3ø)	420	6.1/13.4	20(1ø)/15(3ø)	420	Possui	Nema 1 (kit eletroduto para a mecânica A)	Possui	Sim	Sim						
CFW11 0007 S 2 O FA	B	1ø	7	7.7	10.5	5	2/1.5	14.4	7	10.5	14	5	2/1.5	14.4	140	25	6.1/13.4	15	420	6.1/13.4	15	420	6.1/13.4	15						420	Possui	Nema 1 (kit eletroduto para a mecânica B)	Possui	Sim	Sim
CFW11 0010 T 2		3ø	10	11	15	5	3/2.2	10	8	12	16	5	3/2.2	20.5	170	30	6.1/13.4	25	1000	6.1/13.4	25	1000	6.1/13.4	25	1000	Possui	Nema 1 (kit eletroduto para a mecânica B)	Possui	Sim	Sim					
CFW11 0010 S 2		1ø	10	11	15	5	3/2.2	20.5	10	15	20	5	3/2.2	20.5	180	30	6.1/13.4	25	1000	6.1/13.4	25	1000	6.1/13.4	25	1000										
CFW11 0013 T 2	3ø	13	14.3	19.5	5	4/3.0	13	11	16.5	22	5	4/3.0	13	200	30	6.1/13.4	25	420	6.1/13.4	25	420	6.1/13.4	25	420	Possui	Nema 1 (kit eletroduto para a mecânica C)	Possui	Sim	Sim						
CFW11 0016 T 2	3ø	16	17.6	24	5	5/3.7	16	13	19.5	26	5	4/3.0	13	230	30	6.3/13.9	25	420	6.3/13.9	25	420	6.3/13.9	25	420						Possui	Nema 1 (kit eletroduto para a mecânica C)	Possui	Sim	Sim	
CFW11 0024 T 2	3ø	24	26.4	36	5	7.5/5.5	24	20	30	40	5	6/4.5	20	310	50	9.1/20	25	1000	9.1/20	25	1000	9.1/20	25	1000	Possui	Nema 1 (kit eletroduto para a mecânica C)	Possui	Sim	Sim						
CFW11 0028 T 2	3ø	28	30.8	42	5	10/7.5	28	24	36	48	5	7.5/5.5	24	370	60	9.1/20	35	1000	9.1/20	35	1000	9.1/20	35	1000						Possui	Nema 1 (kit eletroduto para a mecânica C)	Possui	Sim	Sim	
CFW11 0033 T 2	3ø	33.5	36.9	50.3	5	12.5/9.2	33.5	28	42	56	5	10/7.5	28	430	60	9.1/20	30	1000	9.1/20	30	1000	9.1/20	30	1000	Possui	Nema 1 (kit eletroduto para a mecânica C)	Possui	Sim	Sim						
CFW11 0045 T 2	3ø	45	49.5	67.5	5	15/11	45	36	54	72	5	12.5/9.2	36	590	90	15.6/34.4	50	2750	15.6/34.4	50	2750	15.6/34.4	50	2750						Possui	Nema 1 (kit eletroduto para a mecânica C)	Possui	Sim	Sim	
CFW11 0054 T 2	3ø	54	59.4	81	5	20/15	54	45	67.5	90	5	15/11	45	680	100	16.0/35.3	70	2750	16.0/35.3	70	2750	16.0/35.3	70	2750	Possui	Nema 1 (kit eletroduto para a mecânica C)	Possui	Sim	Sim						
CFW11 0070 T 2	3ø	70	77	105	5	25/18.5	70	56	84	112	5	20/15	56	900	140	17.9/39.5	80	2750	17.9/39.5	80	2750	17.9/39.5	80	2750						Possui	Nema 1 (kit eletroduto para a mecânica C)	Possui	Sim	Sim	
CFW11 0086 T 2	3ø	86	94.6	129	5	30/22	86	70	105	140	5	25/18.5	70	970	150	29.5/65.1	100	3150	29.5/65.1	100	3150	29.5/65.1	100	3150	Possui	Nema 1 (kit eletroduto para a mecânica D)	Possui	Sim	Sim						
CFW11 0105 T 2	3ø	105	116	158	5	40/30	105	86	129	172	5	30/22	86	1200	180	31.4/69.2	125	3150	31.4/69.2	125	3150	31.4/69.2	125	3150						Possui	Nema 1 (kit eletroduto para a mecânica D)	Possui	Sim	Sim	
CFW11 0003 T 4	A	3ø	3.6	3.96	5.40	5	2/1.5	3.6	3.6	5.4	7.2	5	2/1.5	3.6	110	25	5.7/12.6	15	190	5.7/12.6	15	190	5.7/12.6	15	190	Possui	Nema 1 (kit eletroduto para a mecânica A)	Possui	Sim						Sim
CFW11 0005 T 4		3ø	5	5.5	7.5	5	3/2.2	5	5	7.5	10	5	3/2.2	5	140	25	5.9/13	15	190	5.9/13	15	190	5.9/13	15	190					Possui	Nema 1 (kit eletroduto para a mecânica A)	Possui	Sim	Sim	
CFW11 0007 T 4		3ø	7	7.7	10.5	5	4/3	7	7	8.25	11	5	3/2.2	5.5	140	25	6.1/13.4	15	190	6.1/13.4	15	190	6.1/13.4	15	190										
CFW11 0010 T 4	3ø	10	11	15	5	6/4.5	10	10	15	20	5	6/4.5	10	200	30	6.3/13.9	20	495	6.3/13.9	20	495	6.3/13.9	20	495	Possui	Nema 1 (kit eletroduto para a mecânica A)	Possui	Sim	Sim						
CFW11 0013 T 4	3ø	13.5	14.9	20.3	5	7.5/5.5	13.5	11	16.5	22	5	6/4.5	11	220	30	6.3/13.9	20	495	6.3/13.9	20	495	6.3/13.9	20	495						Possui	Nema 1 (kit eletroduto para a mecânica A)	Possui	Sim	Sim	
CFW11 0017 T 4	3ø	17	18.7	25.5	5	10/7.5	17	13.5	20.3	27	5	7.5/5.5	13.5	270	40	9.1/20	25	495	9.1/20	25	495	9.1/20	25	495	Possui	Nema 1 (kit eletroduto para a mecânica B)	Possui	Sim	Sim						
CFW11 0024 T 4	3ø	24	26.4	36	5	15/11	24	19	28.5	38	5	10/7.5	19	360	50	9.7/21.4	35	500	9.7/21.4	35	500	9.7/21.4	35	500						Possui	Nema 1 (kit eletroduto para a mecânica B)	Possui	Sim	Sim	
CFW11 0031 T 4	3ø	31	34.1	46.5	5	20/15	31	25	37.5	50	5	15/11	25	430	60	10.4/22.9	35	1250	10.4/22.9	35	1250	10.4/22.9	35	1250	Possui	Nema 1 (kit eletroduto para a mecânica B)	Possui	Sim	Sim						
CFW11 0038 T 4	3ø	38	41.8	57	5	25/18.5	38	33	49.5	66	5	20/15	33	590	90	16.4/36.2	50	1250	16.4/36.2	50	1250	16.4/36.2	50	1250						Possui	Nema 1 (kit eletroduto para a mecânica B)	Possui	Sim	Sim	
CFW11 0045 T 4	3ø	45	49.5	67.5	5	30/22	45	38	57	76	5	25/18.5	38	650	100	19.6/43.2	50	2100	19.6/43.2	50	2100	19.6/43.2	50	2100	Possui	Nema 1 (kit eletroduto para a mecânica C)	Possui	Sim	Sim						
CFW11 0058 T 4	3ø	58.5	64.4	87.8	5	40/30	58.5	47	70.5	94	5	30/22	47	800	120	20.5/45.2	70	2100	20.5/45.2	70	2100	20.5/45.2	70	2100						Possui	Nema 1 (kit eletroduto para a mecânica C)	Possui	Sim	Sim	
CFW11 0070 T 4	3ø	70.5	77.6	106	5	50/37	70.5	61	91.5	122	5	40/30	61	1050	160	31.1/68.6	80	2100	31.1/68.6	80	2100	31.1/68.6	80	2100	Possui	Nema 1 (kit eletroduto para a mecânica C)	Possui	Sim	Sim						
CFW11 0088 T 4	3ø	88	96.8	132	5	60/45	88	73	110	146	5	50/37	73	1170	180	32.6/71.8	100	3150	32.6/71.8	100	3150	32.6/71.8	100	3150						Possui	Nema 1 (kit eletroduto para a mecânica D)	Possui	Sim	Sim	

Modelos com alimentação em 200... 240 V

Modelos com alimentação em 380... 480 V

Tabela A.2: Especificações técnicas dos modelos das mecânicas E a G

Modelo	Mecânica	Alimentação	Uso em Regime de Sobrecarga Normal (ND)				Uso em Regime de Sobrecarga Pesada (HD)				Peso [kg (lb)]	Fusível [A] conforme Norma Européia IEC	I ² t do fusível [A ² s] @ 25 °C	Temperatura Ambiente ao Redor do Inversor [°C (°F)]	Frenagem Reostática	Grau de Proteção do Gabinete	Filtro RFI	Parada de Segurança	Alimentação Externa da Eletrônica em 24 Vcc	Disponibilidade de Opcionais que Podem ser Agregados ao Produto												
			Corrente de Saída Nominal [Arms]	Corrente de Sobrecarga [Arms]	Frequência de Chaveamento Nominal [kHz]	Motor Máximo [HP/kW]	Corrente de Entrada Nominal [Arms]	Potência Dissipada [W]	Corrente de Saída Nominal [Arms]	Corrente de Sobrecarga [Arms]											Frequência de Chaveamento Nominal [kHz]	Motor Máximo [HP/kW]	Potência Dissipada [W]									
CFW11 0142 T 2		3ø	142	156,2	213	2,5	50/37	142	1490	210	115	172,5	230	5	40/30	115	1280	200	200	64,0 (141,1)	200	39200	-10...45 (14... 113)	Opcional (o produto padrão não possui frenagem reostática)	Nema 1 (kit KNIE-01)	Possui						
CFW11 0180 T 2		3ø	180	198	270	2,5	60/45	180	1820	360	142	213	284	5	50/37	142	1550	350	350	65,0 (143,3)	200	218000	-10...45 (14... 113)	Opcional (o produto padrão não possui frenagem reostática)	Nema 1 (kit KNIE-02)	Possui						
CFW11 0211 T 2		3ø	211	232	317	2,5	75/55	211	2040	360	180	270	360	2,5	75/55	180	1690	350	350	65,0 (143,3)	250	218000	-10...45 (14... 113)	Opcional (o produto padrão não possui frenagem reostática)	Nema 1 (kit KNIE-02)	Possui						
CFW11 0105 T 4	E	3ø	105	115,5	157,5	2,5	75/55	105	1270	200	88	132	176	2,5	60/45	88	1020	190	190	62,5 (137,8)	125	39200	-10...45 (14... 113)	Opcional (o produto padrão não possui frenagem reostática)	Nema 1 (kit KNIE-01)	Possui						
CFW11 0142 T 4		3ø	142	156,2	213	2,5	100/75	142	1680	210	115	172,5	230	2,5	75/55	115	1290	200	200	64,0 (141,1)	200	39200	-10...45 (14... 113)	Opcional (o produto padrão não possui frenagem reostática)	Nema 1 (kit KNIE-01)	Possui						
CFW11 0180 T 4		3ø	180	198	270	2,5	150/110	180	2050	360	142	213	284	2,5	100/75	142	1570	350	350	65,0 (143,3)	200	218000	-10...45 (14... 113)	Opcional (o produto padrão não possui frenagem reostática)	Nema 1 (kit KNIE-01)	Possui						
CFW11 0211 T 4		3ø	211	232,1	317	2,5	175/132	211	2330	360	180	270	360	2,5	150/110	180	1940	350	350	65,0 (143,3)	250	218000	-10...45 (14... 113)	Opcional (o produto padrão não possui frenagem reostática)	Nema 1 (kit KNIE-02)	Possui						
CFW11 0242 T 4		3ø	242	266	363	2,5	200/150	242	1518	285	211	317	422	2,5	175/132	211	1277	227	227	130 (286,6)	315	320000	-10...45 (14... 113)	Opcional (o produto padrão não possui frenagem reostática)	Nema 1 (kit KNIE-02)	Possui						
CFW11 0312 T 4		3ø	312	343	468	2,5	250/185	312	2034	375	242	363	484	2,5	200/150	242	1507	292	292	132 (291,0)	500	414000	-10...45 (14... 113)	Opcional (o produto padrão não possui frenagem reostática)	Nema 1 (kit KNIE-02)	Possui						
CFW11 0370 T 4	F	3ø	370	407	555	2,5	300/220	370	2497	407	312	468	624	2,5	250/185	312	2008	320	320	135 (297,6)	500	414000	-10...45 (14... 113)	Opcional (o produto padrão não possui frenagem reostática)	Nema 1 (kit KNIE-02)	Possui						
CFW11 0477 T 4		3ø	477	525	716	2,5	400/300	477	3273	595	370	555	740	2,5	300/220	370	2451	465	465	140 (308,6)	700	1051000	-10...45 (14... 113)	Opcional (o produto padrão não possui frenagem reostática)	Nema 1 (kit KNIE-02)	Possui						
CFW11 0515 T 4		3ø	515	567	773	2	400/300	515	3338	769	477	716	954	2	400/300	477	2987	644	644	204 (449,7)	900	1445000	-10...45 (14... 113)	Opcional (o produto padrão não possui frenagem reostática)	Nema 1 (kit KNIE-02)	Possui						
CFW11 0601 T 4	G	3ø	601	662	900	2	500/370	601	3875	781	515	773	1030	2	400/300	515	3219	639	639	207 (456,4)	900	1445000	-10...45 (14... 113)	Opcional (o produto padrão não possui frenagem reostática)	Nema 1 (kit KNIE-02)	Possui						
CFW11 0720 T 4		3ø	720	792	1080	2	600/440	720	4576	858	560	840	1120	2	450/330	560	3747	653	653	215 (474,0)	1100	1445000	-10...40 (14... 104)	Opcional (o produto padrão não possui frenagem reostática)	Nema 1 (kit KNIE-02)	Possui						

Modelos com alimentação em 380... 440 V

Obs.:

- (1) Corrente nominal em regime permanente nas seguintes condições:
 - Frequências de chaveamento específicas.
 - Temperatura ambiente ao redor do inversor conforme especificado nas tabelas. Para temperaturas maiores, limitado a 10 °C acima da temperatura máxima especificada para condições nominais, a corrente de saída deve ser reduzida de 2 % para cada °C acima da temperatura máxima especificada.
 - Umidade relativa do ar: 5% a 90 % sem condensação.
 - Altitude: 1000 m. Acima de 1000 m até 4000 m a corrente de saída deve ser reduzida de 1 % para cada 100 m acima de 1000 m.
 - Ambiente com grau de poluição 2 (conforme EN50178 e UL508C).
- (2) As potências dos motores são apenas orientativas para motor WEG 230 V ou 460 V, 4 pólos. O dimensionamento correto deve ser feito em função das correntes nominais dos motores utilizados.

Tabela A.3: Especificações da frenagem reostática para mecânicas A a E

Modelo do Inversor	Corrente Máxima de Frenagem ($I_{máx}$) [A]	Potência Máxima (de pico) de Frenagem ($P_{máx}$) ⁽²⁾ [kW]	Corrente Eficaz de Frenagem (I_{eficaz}) ⁽¹⁾ [A]	Potência (média) Dissipada no Resistor de Frenagem (P_R) ⁽²⁾ [kW]	Resistor Recomendado [Ω]	Fiação de Potência (bornes DC+ e BR) [mm ² (AWG)]
CFW11 0006 B 2	5.3	2.1	5.2	2.03	75	1.5 (16)
CFW11 0006 S 2 O FA	5.3	2.1	5.2	2.03	75	1.5 (16)
CFW11 0007 B 2	7.1	2.9	6.96	2.71	56	1.5 (16)
CFW11 0007 S 2 O FA	7.1	2.9	6.96	2.71	56	1.5 (16)
CFW11 0007 T 2	5.3	2.1	5.2	2.03	75	1.5 (16)
CFW11 0010 S 2	11.1	4.4	10.83	4.22	36	2.5 (14)
CFW11 0010 T 2	7.1	2.9	6.96	2.71	56	1.5 (16)
CFW11 0013 T 2	11.1	4.4	8.54	2.62	36	2.5 (14)
CFW11 0016 T 2	14.8	5.9	14.44	5.63	27	4 (12)
CFW11 0024 T 2	26.7	10.7	19.15	5.5	15	6 (10)
CFW11 0028 T 2	26.7	10.7	18.21	4.97	15	6 (10)
CFW11 0033 T 2	26.7	10.7	16.71	4.19	15	6 (10)
CFW11 0045 T 2	44	17.6	33.29	10.1	9.1	10 (8)
CFW11 0054 T 2	48.8	19.5	32.17	8.49	8.2	10 (8)
CFW11 0070 T 2	48.8	19.5	26.13	5.6	8.2	6 (8)
CFW11 0086 T 2	93	37.2	90.67	35.3	4.3	35 (2)
CFW11 0105 T 2	111.1	44.4	90.87	29.7	3.6	35 (2)
CFW11 0003 T 4	3.6	2.9	3.54	2.76	220	1.5 (16)
CFW11 0005 T 4	5.3	4.3	5.2	4.05	150	1.5 (16)
CFW11 0007 T 4	5.3	4.3	5.2	4.05	150	1.5 (16)
CFW11 0010 T 4	8.8	7	8.57	6.68	91	2.5 (14)
CFW11 0013 T 4	10.7	8.5	10.4	8.11	75	2.5 (14)
CFW11 0017 T 4	12.9	10.3	12.58	9.81	62	2.5 (12)
CFW11 0024 T 4	17	13.6	16.59	12.9	47	4 (10)
CFW11 0031 T 4	26.7	21.3	20.49	12.6	30	6 (10)
CFW11 0038 T 4	36.4	29.1	26.06	14.9	22	6 (8)
CFW11 0045 T 4	47.1	37.6	40	27.2	17	10 (8)
CFW11 0058 T 4	53.3	42.7	31.71	15.1	15	10 (8)
CFW11 0070 T 4	66.7	53.3	42.87	22.1	12	10 (6)
CFW11 0088 T 4	87.9	70.3	63.08	36.2	9.1	25 (4)
CFW11 0142 T 2 O DB	266.7	106.7	142	30.2	1.5	70 (2/0) ou 2x 25 (2x 4)
CFW11 0180 T 2 O DB	266.7	106.7	180	48.6	1.5	120 (4/0) ou 2x 35 (2x 2)
CFW11 0211 T 2 O DB	333.3	133.3	211	53.4	1.2	150 (300) ou 2x 50 (2x 1)
CFW11 0105 T 4 O DB	186	148.8	105	47.4	4.3	50 (1)
CFW11 0142 T 4 O DB	266.7	213.3	142	60.5	3	70 (2/0) ou 2x 25 (2x 4)
CFW11 0180 T 4 O DB	266.7	213.3	180	97.2	3	120 (4/0) ou 2x 35 (2x 2)
CFW11 0211 T 4 O DB	363.6	290.9	191.7	80.8	2.2	120 (250) ou 2x 50 (2x 1)

Notas:

(1) A corrente eficaz de frenagem apresentada é apenas um valor orientativo, pois depende da razão cíclica da frenagem na aplicação. Para obter a corrente eficaz de frenagem utilize a equação abaixo, onde t_{br} é dado em minutos e corresponde à soma dos tempos de atuação da frenagem durante o mais severo ciclo de 5 minutos.

$$I_{eficaz} = I_{máx} \cdot \sqrt{\frac{t_{br}}{5}}$$

(2) Os valores de $P_{máx}$ e P_R (potência máxima e média do resistor de frenagem respectivamente) apresentados são válidos para os resistores recomendados e para as correntes eficazes de frenagem apresentadas na tabela acima. A potência do resistor deve ser modificada de acordo com a razão cíclica da frenagem.



Frequenzumrichter

Installationsanleitung

Reihe: CFW-11

Sprache: Deutsch

Dokument: 10001803811 / 00

Ausgabe: 01/2013

DEUTSCH

FRANÇAIS

РУССКИЙ

NEDERLANDS

ITALIANO

INHALT

EINLEITUNG	67
SICHERHEITSHINWEISE	67
GERÄTEBESCHREIBUNG DES CFW-11	67
LIEFERUNG UND LAGERUNG	67
MECHANISCHE INSTALLATION.....	67
ALLGEMEINE HINWEISE ZUR MONTAGE.....	67
GEHÄUSEMONTAGE	68
ELEKTRISCHE INSTALLATION	70
ANSCHLUSSPLÄNE.....	70
HINWEISE ZU STROMKREISEN UND ELEKTRISCHEN GERÄTEN	71
IT-NETZE	72
ERDUNGSANSCHLÜSSE	72
STEUERANSCHLÜSSE.....	73
INSTALLATION GEMÄSS EU-RICHTLINIE ÜBER DIE ELEKTROMAGNETISCHE VERTRÄGLICHKEIT ..	75
INTEGRIERTES BEDIENGERÄT – HMI-CFW11	76
PARAMETERSTRUKTUR.....	77
INBETRIEBNAHME	77
VORBEREITUNG ZUR INBETRIEBNAHME	77
INBETRIEBNAHME IM U/F-MODUS.....	77
DATUM UND UHRZEIT EINSTELLEN.....	78
SCHUTZ VOR UNZULÄSSIGEN PARAMETERÄNDERUNGEN	78
FUNKTIONEN DES FLASH-SPEICHERMODULS.....	78
ANHANG 1 – TECHNISCHE DATEN	79

EINLEITUNG

Diese Installationsanleitung beschreibt die Installation der Frequenzumrichter CFW-11, Baugröße A bis G, sowie deren Inbetriebnahme im U/f-Modus.

Nähere Informationen finden Sie in der Betriebsanleitung sowie im Programmierhandbuch der CFW-11-Serie.

Neben der U/f-Steuerung bietet der Frequenzumrichter CFW-11 folgende Regelungsarten: VVW-Spannungsvektorregelung, sensorlose Vektorregelung und Vektorregelung mit Geber bei Asynchronmotoren sowie sensorlose Vektorregelung und Vektorregelung mit Geber bei Permanentmagnetmotoren (PM-Motoren). Nähere Hinweise hierzu finden Sie im Programmierhandbuch.

Informationen zu weiteren Funktionen, zum Zubehör sowie zur Kommunikation entnehmen Sie bitte den entsprechenden Handbüchern, die auf der WEG-Website unter www.weg.net zum Download zur Verfügung stehen.

SICHERHEITSHINWEISE

Lesen Sie vor der Installation und Inbetriebnahme des Frequenzumrichters die vorliegende Anleitung vollständig durch.

Die Installation und Inbetriebnahme des Frequenzumrichters sowie ggf. Maßnahmen zur Störungsbeseitigung dürfen ausschließlich von geschultem Fachpersonal durchgeführt werden. Dabei sind sämtliche Sicherheitshinweise zu beachten, die in dieser Anleitung bzw. in den am Installationsort geltenden Vorschriften aufgeführt sind.



GEFAHR!

Die Nichteinhaltung der Sicherheitshinweise kann zum Tod, zu schweren Verletzungen und zu Sachschäden führen.

Trennen Sie den Frequenzumrichter von der Spannungsquelle oder schalten Sie die Spannungsversorgung aus, bevor Sie elektrische Bauteile und Komponenten des Geräts berühren. Auch nach dem Ausschalten der Spannungsversorgung können einzelne Bauteile noch unter gefährlicher Spannung stehen oder sich bewegen (Lüfter).

Warten Sie deshalb mindestens 10 Minuten, bis die Kondensatoren vollständig entladen sind.

Stellen Sie sicher, dass das Gerätegehäuse mit der Schutzterde (PE) verbunden ist.



HINWEIS!

Der Begriff „Fachpersonal“ im Sinne dieser Anleitung bezeichnet Personen, die geschult und in der Lage sind:

1. den CFW-11 unter Einhaltung der Vorgaben dieser Anleitung und der geltenden gesetzlichen Sicherheitsvorschriften zu installieren, zu erden, in Betrieb zu nehmen und zu bedienen.
2. die Schutzausrüstung gemäß den geltenden Vorschriften zu verwenden.
3. Erste Hilfe zu leisten.



HINWEIS!

Der Frequenzumrichter kann Interferenzen mit anderen elektronischen Geräten verursachen. Befolgen Sie die Installationshinweise, um derartige Störungen möglichst zu vermeiden.

GERÄTEBESCHREIBUNG DES CFW-11

Die leistungsstarken Frequenzumrichter der Serie CFW-11 sind in einem Leistungsbereich von 0,75 bis 450 kW in sieben verschiedenen Baugrößen und mit einer Eingangsspannung von 200 V bis 480 V erhältlich. Sie sind für die Drehzahl- und Drehmomentregelung von Drehstrom-Asynchronmotoren und Permanentmagnetmotoren ausgelegt. Das Hauptmerkmal der CFW-11-Serie ist die „Vectrue“-Technologie, die folgende Regelungsarten ermöglicht: skalare U/f-Steuerung, VVW-Spannungsvektorregelung, sensorlose Vektorregelung und Vektorregelung mit Geber. Zusätzliche Highlights sind folgende Funktionen: „Optimal Braking“ (geregelt Bremsen), „Self-Tuning“ (Selbsteinstellung) und „Optimal Flux“ (optimale Flusssteuerung).

Nähere Informationen finden Sie in der Betriebsanleitung sowie im Programmierhandbuch der CFW-11-Serie.

LIEFERUNG UND LAGERUNG

Prüfen Sie nach Eingang der Lieferung, ob:

die Daten auf dem Typenschild des CFW-11 mit den Daten in der Bestellung übereinstimmen. Nähere Hinweise zu den Modellen und technischen Daten finden Sie in [Tabelle A.1](#) und [A.2](#).

Transportschäden vorliegen. Festgestellte Schäden sind sofort dem Spediteur zu melden.

Wird der CFW-11 nicht unmittelbar nach Anlieferung installiert, so ist er in der Originalverpackung an einem sauberen und trockenen Ort (bei Lagertemperaturen zwischen -25 °C und 60 °C) zu lagern.

MECHANISCHE INSTALLATION

UMGEBUNGSBEDINGUNGEN

Zu vermeiden sind:

- direkte Sonneneinstrahlung, Niederschlag, hohe Luftfeuchtigkeit und Seeluft.
- entflammbare oder korrosive Gase und Flüssigkeiten.
- übermäßige Erschütterungen.
- Staub, Metallpartikel und Ölnebel.
- Die Umgebungsbedingungen gemäß [Tabelle A.1](#) und [A.2](#) sind einzuhalten.

ALLGEMEINE HINWEISE ZUR MONTAGE

Beachten Sie die Angaben zum Gewicht des Frequenzumrichters in [Tabelle A.1](#) und [A.2](#).

Montieren Sie den Frequenzumrichter in aufrechter Position an einer flachen, vertikalen Fläche.

Die Außenmaße und die Lage der Befestigungsbohrungen entnehmen Sie bitte [Abb. 1](#).

Damit Luft zum Kühlen des Geräts frei zirkulieren kann, sind bei der Montage die Mindestabstände nach [Abb. 2](#) einzuhalten.

Hinweis:

- Bei den Baugrößen A, B und C können die Frequenzumrichter ohne Montageabstand direkt nebeneinander montiert werden, sofern die obere Gehäuseabdeckung entfernt wird.

Installieren Sie keine hitzeempfindlichen Bauteile unmittelbar oberhalb des Frequenzumrichters.

GEHÄUSEMONTAGE

Wandmontage:

Sorgen Sie für eine ausreichende Entlüftung, damit die zulässige Gehäuseinnentemperatur während des Umrichterbetriebs nicht überschritten wird.

Die Verlustleistung des Frequenzumrichters bei Nennbetriebsbedingungen ist in [Tabelle A.1](#) und [A.2](#) unter „Verlustleistung in Watt – Wandmontage“ angegeben.

Die für das Umrichtergehäuse erforderliche Kühlluftmenge entnehmen Sie bitte [Tabelle 1](#).

Position und Durchmesser der Montagebohrungen sind in [Abb. 1](#) dargestellt.

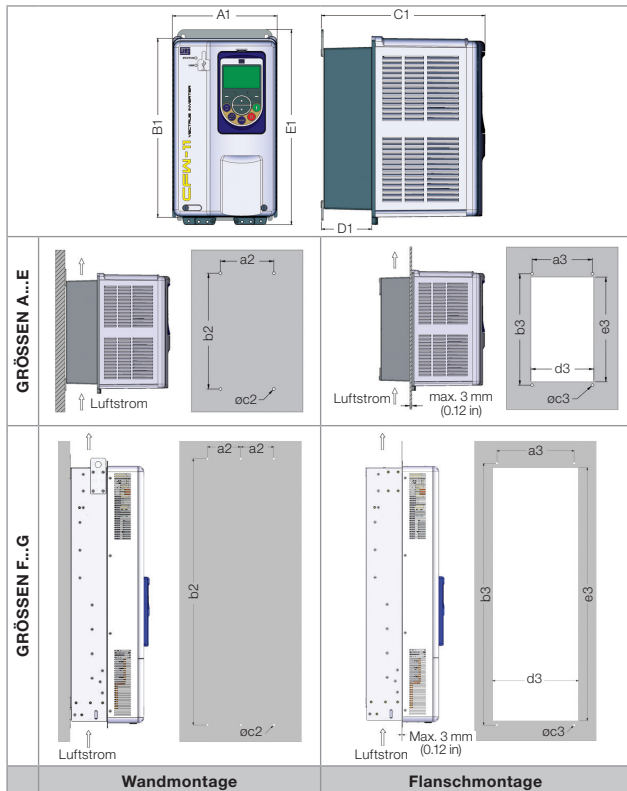

Modell	A1	B1	C1	D1	E1	a2	b2	c2	a3	b3	c3	d3	e3
	mm (in)	mm (in)	mm (in)	mm (in)	mm (in)	mm (in)	mm (in)	M	mm (in)	mm (in)	M	mm (in)	mm (in)
Größe A	145 (5.71)	247 (9.73)	227 (8.94)	70 (2.75)	270 (10.63)	115 (4.53)	250 (9.85)	M5	130 (5.12)	240 (9.45)	M5	135 (5.32)	225 (8.86)
Größe B	190 (7.48)	293 (11.53)	227 (8.94)	71 (2.78)	316 (12.43)	150 (5.91)	300 (11.82)	M5	175 (6.89)	285 (11.23)	M5	179 (7.05)	271 (10.66)
Größe C	220 (8.67)	378 (14.88)	293 (11.53)	136 (5.36)	405 (15.95)	150 (5.91)	375 (14.77)	M6	195 (7.68)	365 (14.38)	M6	205 (8.08)	345 (13.59)
Größe D	300 (11.81)	504 (19.84)	305 (12.00)	135 (5.32)	550 (21.65)	200 (7.88)	525 (20.67)	M8	275 (10.83)	517 (20.36)	M8	285 (11.23)	485 (19.10)
Größe E	335 (13.19)	620 (24.41)	358 (14.09)	168 (6.61)	675 (26.57)	200 (7.88)	650 (25.59)	M8	275 (10.83)	635 (25.00)	M8	315 (12.40)	615 (24.21)
Größe F	430 (16.93)	1156 (45.51)	360 (14.17)	169 (6.65)	1234 (48.58)	150 (5.91)	1200 (47.24)	M10	350 (13.78)	1185 (46.65)	M10	391 (15.39)	1146 (45.12)
Größe G	535 (21.06)	1190 (46.85)	426 (16.77)	202 (7.95)	1264 (49.76)	200 (7.87)	1225 (48.23)	M10	400 (15.75)	1220 (48.03)	M10	495 (19.49)	1182 (46.53)

Toleranz für d3 und e3: +1,0 mm (+0.039 in)
Allgemeine Toleranz: ±1,0 mm (± 0.039 in)

Abb. 1: Mechanische Installation

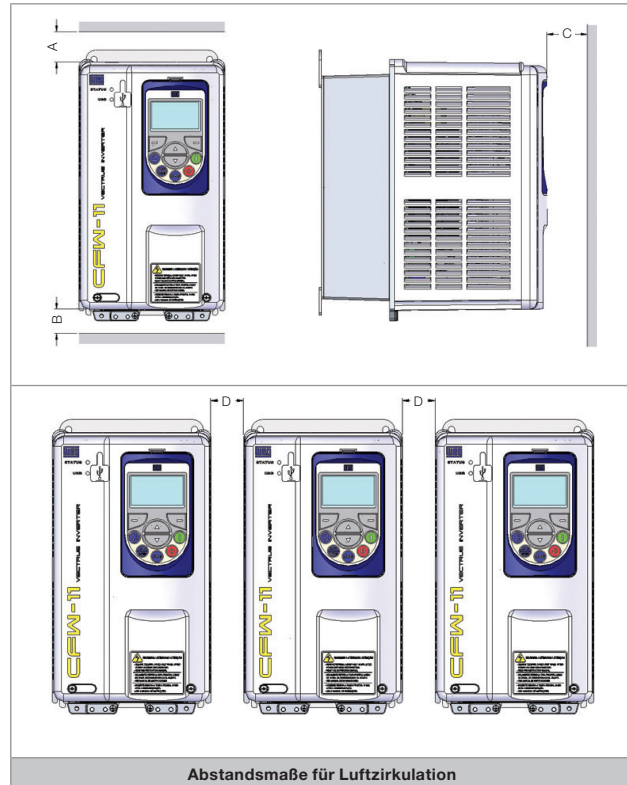

Abstandsmaße für Luftzirkulation

Modell	A	B	C	D
	mm (in)	mm (in)	mm (in)	mm (in)
Größe A	25 (0.98)	25 (0.98)	10 (0.39)	30 (1.18)
Größe B	40 (1.57)	45 (1.77)		
Größe C	110 (4.33)	130 (5.12)		
Größe D	100 (3.94)	130 (5.12)	20 (0.78)	40 (1.57)
Größe E	0142 T2	150 (5.91)		80 (3.15)
	0211 T2	100 (3.94)		40 (1.57)
	0142 T4	150 (5.91)		80 (3.15)
	0211 T4	150 (5.91)		80 (3.15)
Größe F				
Größe G				

Toleranz: ±1.0 mm (± 0.039 in)

Abb. 2: Mindestabstände für Umrichter-Kühlluftzirkulation

Tabelle 1: Erforderliche Kühlluftmenge für Umrichtergehäuse

Baugröße	Modell	cfm	l/s	m³/min
A	alle	18	8	0.5
B	alle	42	20	1.2
C	alle	96	45	2.7
D	alle	132	62	3.7
E	CFW11 0142 T 2	138	65	3.9
	CFW11 0180 T 2	265	125	7.5
	CFW11 0211 T 2			
	CFW11 0105 T 4	138	65	3.9
	CFW11 0142 T 4	180	95	5.1
	CFW11 0180 T 4	265	125	7.5
CFW11 0211 T 4				
F	CFW11 0242 T 4	250	118	7.1
	CFW11 0312 T 4	320	151	9.1
	CFW11 0370 T 4	380	180	10.1
	CFW11 0477 T 4	460	217	13
	CFW11 0515 T 4	680	321	19.3
CFW11 0601 T 4				
G	CFW11 0720 T 4			

Flanschmontage:

Der in [Tabelle A.1](#) und [A.2](#) unter „Verlustleistung in Watt – Flanschmontage“ angegebene Leistungsverlust ergibt sich innerhalb des Gehäuses. Der restliche Leistungsverlust erfolgt über die Gehäuserückseite.

Die Montagehalterungen und Transportösen sind bei Baugröße E, F und G zu versetzen. Siehe hierzu [Abb. 3](#) und [4](#).

Der außerhalb des Gehäuses befindliche Teil des Frequenzumrichters ist bei Baugröße A bis E für die Schutzart IP54, bei Baugröße F und G für die Schutzart IP20 ausgelegt.

Für die Gehäuseöffnung ist eine geeignete Dichtung zu verwenden, damit die Schutzart des Gehäuses erhalten bleibt. Beispiel: Silikondichtung.

Die Befestigungsmaße der Montagefläche sowie Position/Durchmesser der Montagebohrungen sind [Abb. 1](#) zu entnehmen.



Abb. 3: Versetzen der Montagehalterungen bei Gr. A bis E. Entfernen der Halterungen bei Gr. F und G



Abb. 4: Befestigung der Transportösen – Gr. E, F, G

Zugang zu den Steuer- und Leistungsklemmen

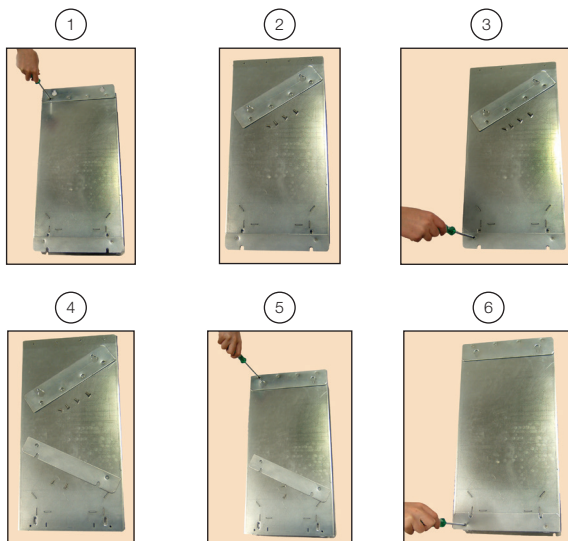
Um Zugang zu den Steuer- und Leistungsklemmen zu erhalten, müssen bei Baugröße A bis C das Bediengerät und die Abdeckung des Steuereinschubs entfernt werden (siehe [Abb. 5](#)).

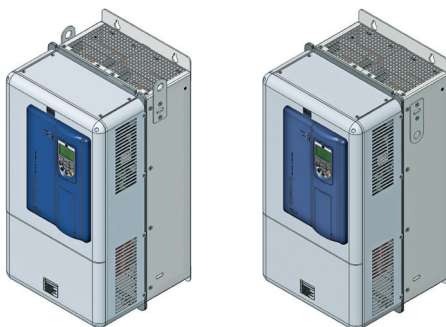

Abb. 5: Entfernung des Bediengeräts und der Abdeckung des Steuereinschubs



Abb. 6: Entfernung des Bediengeräts und der Steuerungsrack-Abdeckung bei Gr. D, E, F, G zwecks Zugang zu den Steuerklemmen

Bei Gr. D bis G sind die Leistungsklemmen erst zugänglich, nachdem die untere frontseitige Abdeckung entfernt wurde (siehe [Abb. 7](#)).

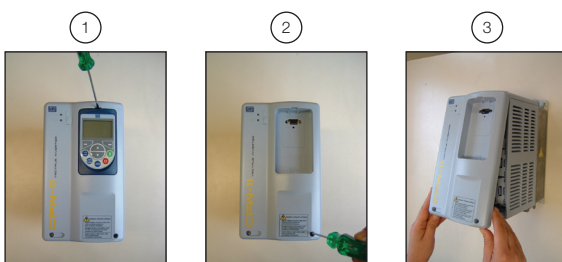

Abb. 7: Entfernung der unteren frontseitigen Abdeckung zwecks Zugang zu den Leistungsklemmen bei Gr. D bis G

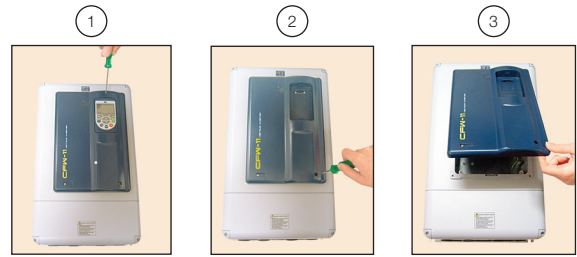
Wenn als Schutzart weder IP20 noch Nema1 erforderlich ist, kann bei Baugröße D und E die Kabeldurchführungsplatte an der Geräteunterseite entfernt werden.

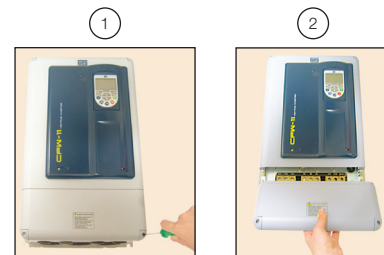

Abb. 8: Entfernung der Kabeldurchführungsplatte

Nehmen Sie bei Baugröße F und G zum Anschluss der Leistungskabel (Netz- und Motorkabel) wie in [Abb 9](#) dargestellt stets die Abdeckplatte an der Geräteunterseite ab.

In diesem Falle reduziert sich die Schutzart des Frequenzumrichter-Unterteils.

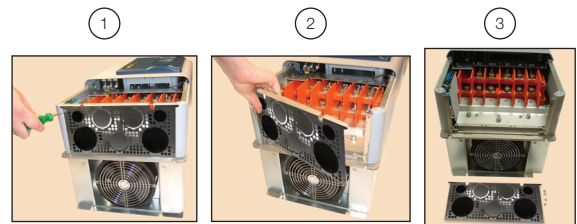

Abb. 9: Entfernung der Kabeldurchführungsplatte bei Gr. F und G

ELEKTRISCHE INSTALLATION

GEFAHR!
Vergewissern Sie sich, dass die Spannungsversorgung ausgeschaltet ist, bevor Sie mit der Installation beginnen.

GEFAHR!
Die nachfolgenden Hinweise dienen lediglich als Orientierungshilfe für eine ordnungsgemäße Installation. Beachten Sie die vor Ort geltenden Vorschriften für die Installation elektrischer Geräte.

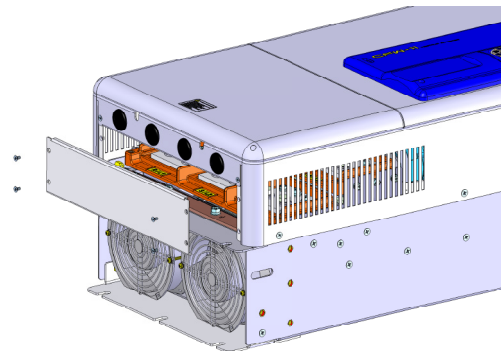
GEFAHR!
Der Anschluss der Eingangsspannungsversorgung an die Ausgangsklemmen führt zu einer Beschädigung des Frequenzumrichters.

ANSCHLUSSPLÄNE

Hinweise:
Die technischen Daten und Angaben zu Netzsicherungen entnehmen Sie bitte [Tabelle A.1](#) und [A.2](#).

Die technischen Daten der Bremswiderstände und Bremsströme finden Sie in [Tabelle A.3](#).



Abb. 10: Anschlussplan für Gr. A, B, C, D, E, F und G in Standardausführung



Abb. 11: Anschlussplan für Gr. F und G mit speziellen DC-Bauteilen

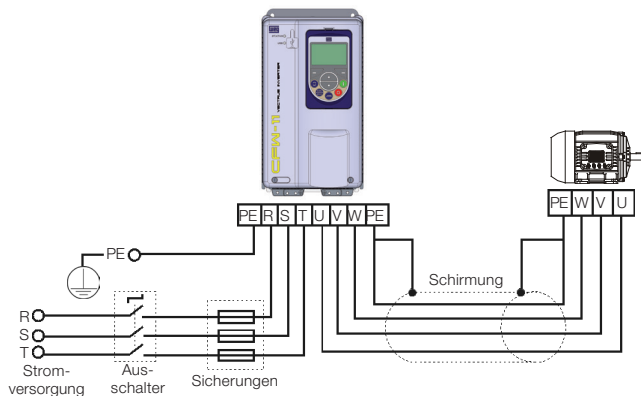

Abb. 12: Anschlussplan des Bremswiderstands bei Gr. A, B, C, D und E

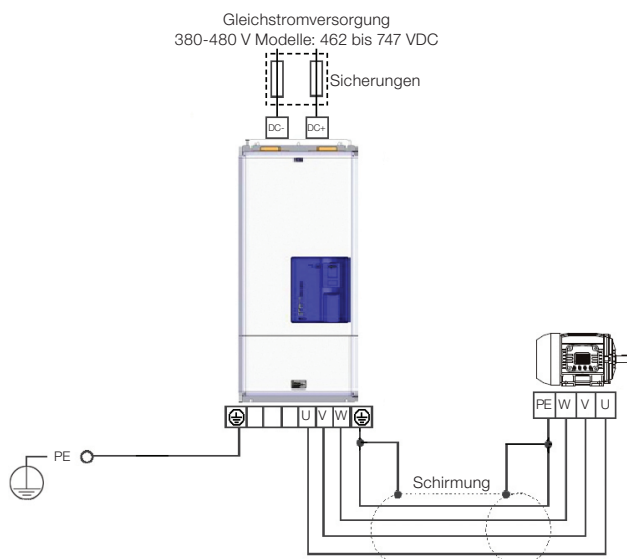

Abb. 13: Anschlussplan für Gr. F und G in Standardausführung mit Bremswiderstand

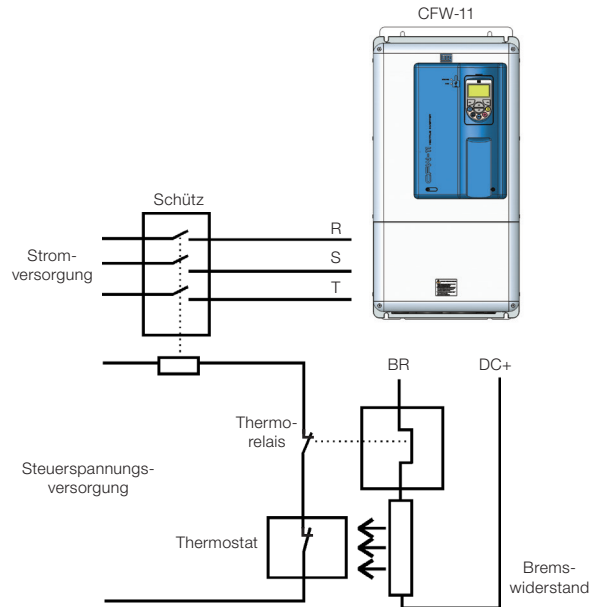

Abb. 14 (a): Leistungs- und Erdungsklemmen bei Gr. A bis C

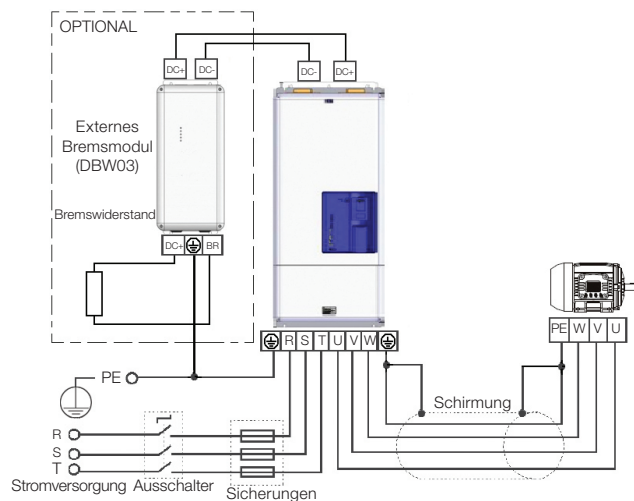

Abb. 14 (b) und (c): Leistungs- und Erdungsklemmen bei Gr. D und E

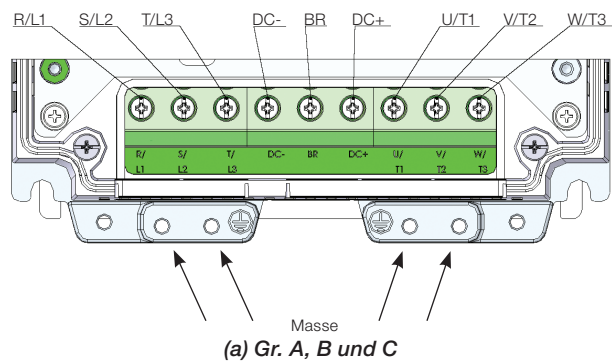

Abb. 15 (a) und (b): Leistungs- und Erdungsklemmen bei Gr. F und G

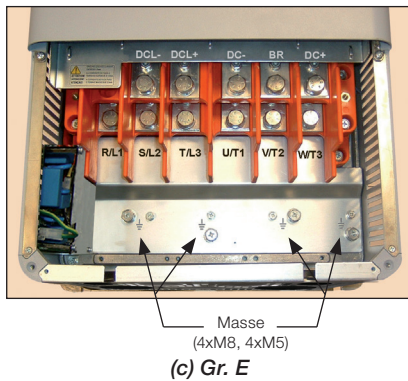
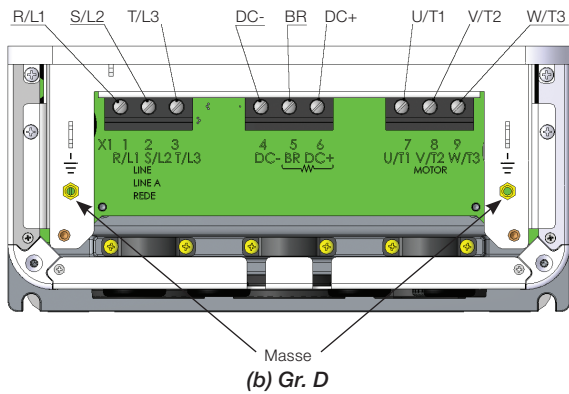

Abb. 16: Anschluss des dynamischen Bremsmoduls bei Gr. F und G in Standardausführung

HINWEISE ZU STROMKREISEN UND ELEKTRISCHEN GERÄTEN

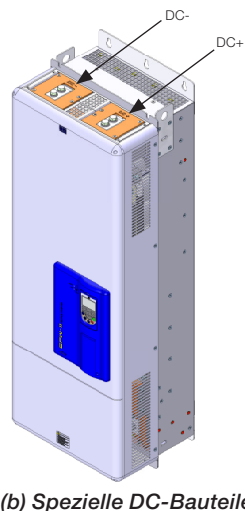
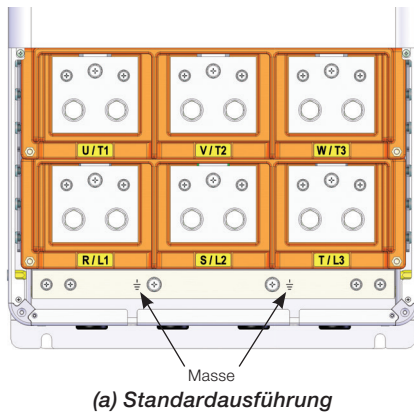
- Die Stromversorgung des Frequenzumrichters muss über einen geerdeten Nullleiter verfügen. Bei IT-Netzen sind einige interne Bauteile gemäß Abb. 17 bis 19 zu trennen.
- Für die Eingangsspannungsversorgung des Frequenzumrichters ist eine Abschaltvorrichtung vorzusehen. Diese Vorrichtung muss bei Bedarf (z.B. bei Wartungsarbeiten) die Eingangsspannung des Umrichters ausschalten.
- Verwenden Sie am Eingang superflinke Sicherungen zum Schutz des Gleichrichters und der Verdrahtung des Umrichters. Angaben zur Auswahl der Sicherungen mit entsprechendem Nennstrom finden Sie in Tabelle A.1 und A.2. (I²t muss kleiner oder gleich dem Tabellenwert sein. Dabei muss der kalte (und nicht der Schmelz-) Löschstromwert berücksichtigt werden.
- Um die Anforderungen der UL-Norm zu erfüllen, müssen Sicherungen der Klasse J am Umrichtereingang verwendet werden, wobei der Nennstrom die Werte in Tabelle A.1 und A.2 nicht überschreiten darf.
- Am Eingang können optional auch träge Sicherungen verwendet werden. Diese müssen für das 1,2-fache des Nennstroms des Umrichters ausgelegt sein. In diesem Fall ist die Anlage kurzschlussicher, nicht jedoch der Eingangs-Gleichrichter des Umrichters. Beim Ausfall eines internen Bauteils kann der Umrichter schwer beschädigt werden.
- Die Frequenzumrichter der Serie CFW-11 sind für Stromkreise bis maximal 100.000 A (Effektivwert, symmetrisch) (230 V / 480 V) geeignet.
- Es wird der Einsatz eines geschirmten Motorkabels nach IEC 60034-25 empfohlen.
- Motorkabel sind in einem Abstand von mindestens 25 cm zu anderen Kabeln wie Signal-, Sensor- und Steuerkabeln usw. zu verlegen.

IT-NETZE

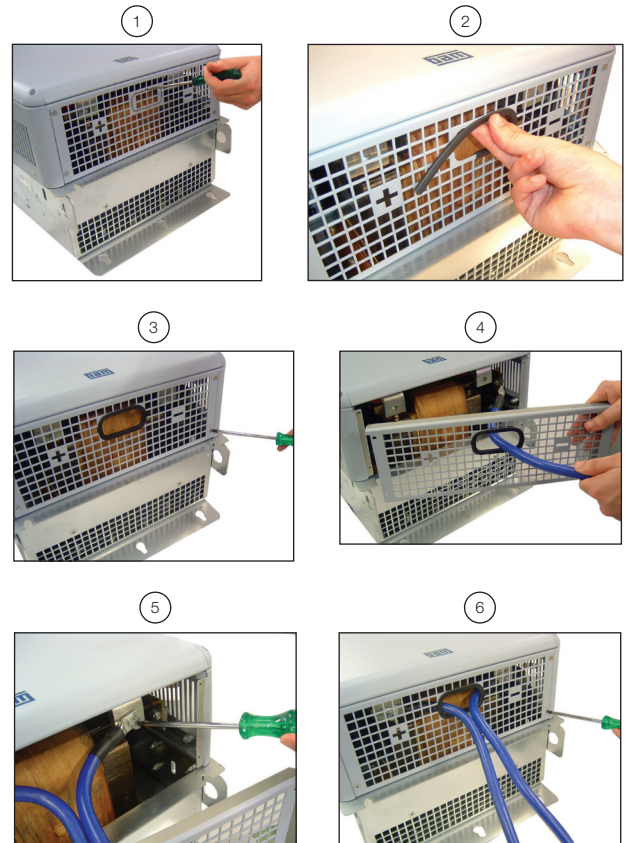
Wenn der Nullleiter nicht geerdet ist oder die Erdung durch einen hochohmigen Widerstand oder in geerdeten (phasengeerdeten) Dreiecksnetzen erfolgt, muss das Kabel mit dem Kabelschuh von der Erdungssammelschiene getrennt und an einen isolierten Punkt am Leistungsklemmenblock angeschlossen werden.



Abb. 17 (a) bis (d): Gr. A bis D – Position der bei IT-Netzen zu entfernenden Erdungsschrauben



(a) Position der Platine

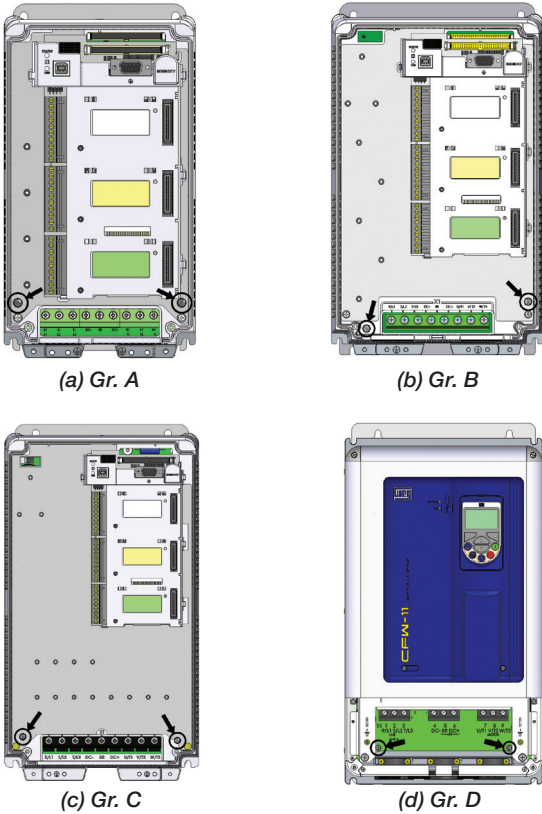
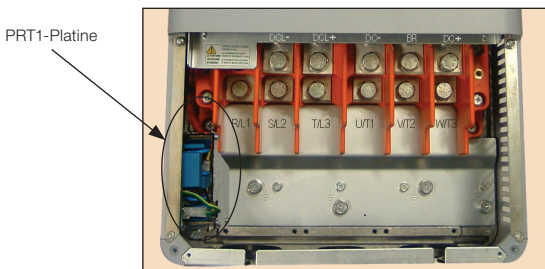
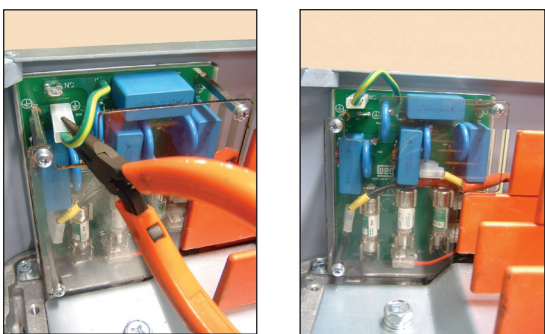

(b) Ursprüngliche Position (c) Geänderte Position (IT)

Abb. 18 (a) bis (c): Gr. E – Klemmenposition auf der PRT1-Platine – bei IT-Netzen zu ändern

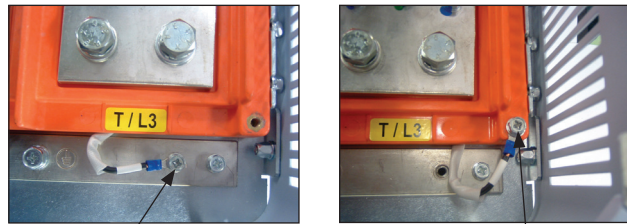

(a) Ursprüngliche Position (b) Geänderte Position

Abb. 19 (a) und (b): Gr. F und G – Klemmenposition auf der PRT1-Platine – bei IT-Netzen zu ändern

ERDUNGSANSCHLÜSSE



GEFAHR!

Der Frequenzumrichter ist an Schutz Erde (PE) anzuschließen. Bei der Auswahl der Erdungsleiterquerschnitte beachten Sie bitte die vor Ort geltenden Vorschriften bzw. die einschlägigen Normen zur Elektrotechnik. Schließen Sie die Erdungsanschlüsse des Umrichters an eine Erdungssammelschiene, an einen einzelnen Masseanschlusspunkt oder an einen gemeinsamen Masseanschlusspunkt (Impedanz $\leq 10 \Omega$) an. Zur Einhaltung der Norm IEC 61800-5-1 ist der Frequenzumrichter mit einem Einzelader-Kupferkabel mit einem Aderquerschnitt von mindestens 10 mm^2 an Masse anzuschließen, da der Kriechstrom über $3,5 \text{ mA}$ Wechselstrom liegt.



ACHTUNG!

Der Nullleiter des Netzanschlusses muss starr geerdet sein. Dieser Leiter darf jedoch nicht für den Masseanschluss des Umrichters verwendet werden.



Abb. 20: Erdungsanschlüsse bei Einsatz mehrerer Frequenzumrichter

STEUERANSCHLÜSSE

Die Steueranschlüsse (analoge Ein-/Ausgänge, digitale Ein-/Ausgänge) müssen auf die Klemmenleiste XC1 der Steuerkarte CC11 geführt werden.

	XC1 Klemmenleiste	Ab Werk eingestellte Funktion
<p>Im Uhrz. $\geq 5 \text{ k}\Omega$ Geg. Uhrz.</p>	1	REF+
	2	AI1+
	3	AI1-
	4	REF-
	5	AI2+
	6	AI2-
<p>U/min</p>	7	AO1
	8	AGND (24 V)
<p>Amp</p>	9	AO2
	10	AGND (24 V)
	11	DGND*
	12	COM
	13	24 VDC
	14	COM
	15	DI1
	16	DI2
	17	DI3
	18	DI4
	19	DI5
	20	DI6
	21	NC1
	22	C1
	23	NO1
	24	NC2
	25	C2
	26	NO2
	27	NC3
	28	C3
	29	NO3

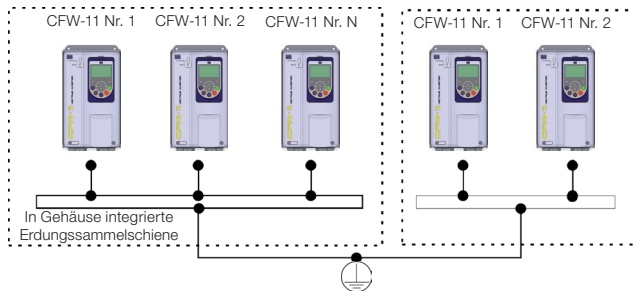
Abb. 21: Signale am Anschluss XC1 – Digitaleingänge mit Funktion „Active High“



HINWEIS!

Zur Verwendung der Digitaleingänge als „Active Low“ entfernen Sie die Brücke zwischen XC1:11 und 12 und installieren Sie diese stattdessen zwischen XC1:12 und 13. Schließen Sie ferner die gemeinsamen Anschlusspunkte der Schalter für DI1 bis DI6 an XC1:11 statt an XC1:13 an.

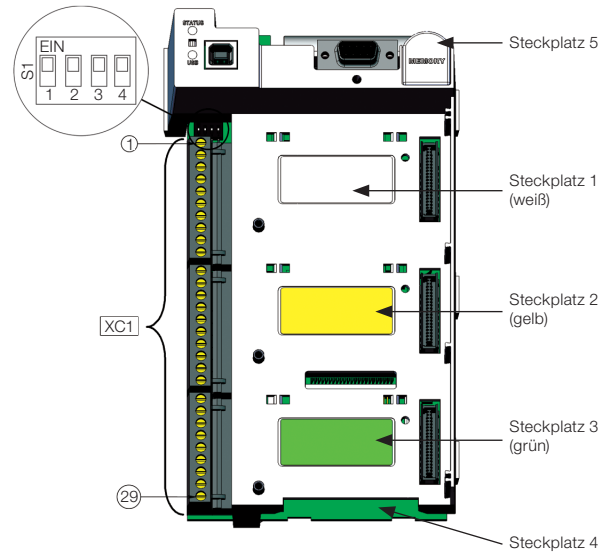

Signal	Ab Werk eingestellte Funktion	DIP-Schalter	Auswahl	Werkseinstellung
AI1	Drehzahlreferenz (Remote)	S1.4	AUS: 0 bis 10 V (Werkseinstellung) EIN: 4 bis 20 mA / 0 bis 20 mA	AUS:
AI2	Ohne Funktion	S1.3	AUS: 0 bis ± 10 V (Werkseinstellung) EIN: 4 bis 20 mA / 0 bis 20 mA	AUS:
AO1	Drehzahl	S1.1	AUS: 4 bis 20 mA / 0 bis 20 mA EIN: 0 bis 10 V (Werkseinstellung)	EIN:
AO2	Motorstrom	S1.2	AUS: 4 bis 20 mA / 0 bis 20 mA EIN: 0 bis 10 V (Werkseinstellung)	EIN:

Abb. 22: DIP-Schalter zur Einstellung des Signaltyps der analogen Ein- und Ausgänge



HINWEIS!



Informationen zur Funktion „Sicherer Halt“ (STO) finden Sie in der Installations-, Konfigurations- und Bedienungsanleitung.

Typische Steueranschlüsse

Steueranschluss 1 – Start-/Stopp-Funktion über Tastatur gesteuert (Local-Modus)

Mit diesem Steueranschluss kann der Umrichter im Local-Modus mit den Werkseinstellungen betrieben werden. Diese Betriebsart wird für Erstbenutzer empfohlen, da keine zusätzlichen Steueranschlüsse erforderlich sind.

Steueranschluss 2 – 2-Draht-Start-/Stopp-Funktion (Remote-Modus)

Dieses Verdrahtungsbeispiel gilt nur bei Verwendung der Werkseinstellungen und für den Umrichterbetrieb im Remote-Modus. Mit den Werkseinstellungen erfolgt die Auswahl der Betriebsart (Local/Remote) über die Taste  auf dem Bediengerät (Standardeinstellung: Local). Stellen Sie P0220 auf 3 ein, um die Standardeinstellung der Taste  auf dem Bediengerät auf Remote umzustellen.



Abb. 23: Verdrahtung von XC1 für Steueranschluss 2

Steueranschluss 3 – 3-Draht-Start-/Stopp-Funktion

Aktivierung der Start-/Stopp-Funktion durch 3-Draht-Steuerung Folgende Parametrierungen sind erforderlich:

DI3 auf START setzen: P0265=6

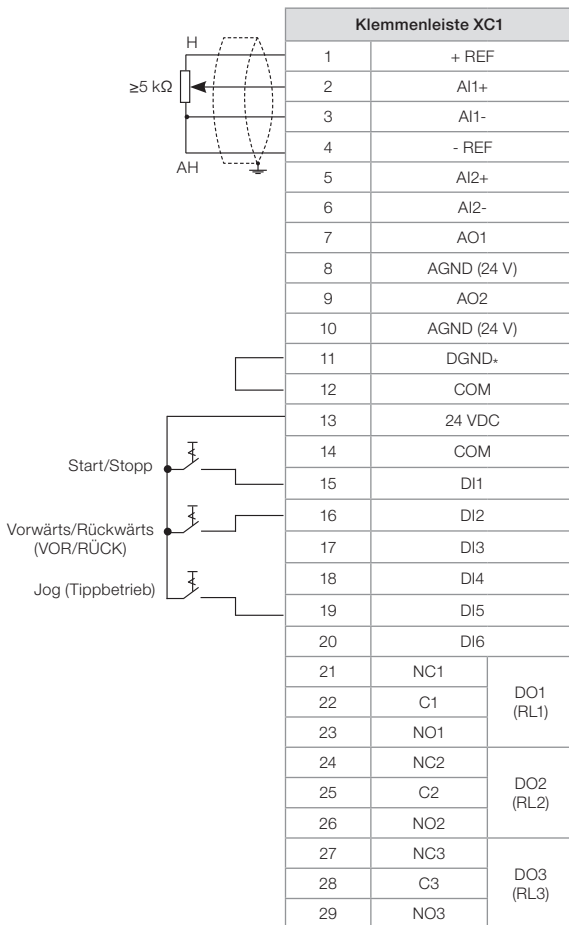
DI4 auf STOP setzen: P0266=7

P0224=1 (DIx) setzen für 3-Draht-Steuerung im Local-Modus.

P0227=1 (DIx) setzen für 3-Draht-Steuerung im Remote-Modus.

Auswahl Vorwärts/Rückwärts über Digitaleingang 2 (DI2).

P0223=4 setzen für Local-Modus oder P0226=4 für Remote-Modus.

S1 und S2 entsprechen jeweils den Tasten Start (Schließer) und Stopp (Öffner).

Die Drehzahlreferenz kann über den Analogeingang (wie bei Steueranschluss 2), über die Tastatur (wie bei Steueranschluss 1) bzw. über eine andere Quelle definiert werden.



Abb. 24: XC1 Verdrahtung von XC1 für Steueranschluss 3

Steueranschluss 4 – Vorwärts/Rückwärts

Aktivierung der Funktion Vorwärts/Rückwärts

Folgende Parametrierungen sind erforderlich:

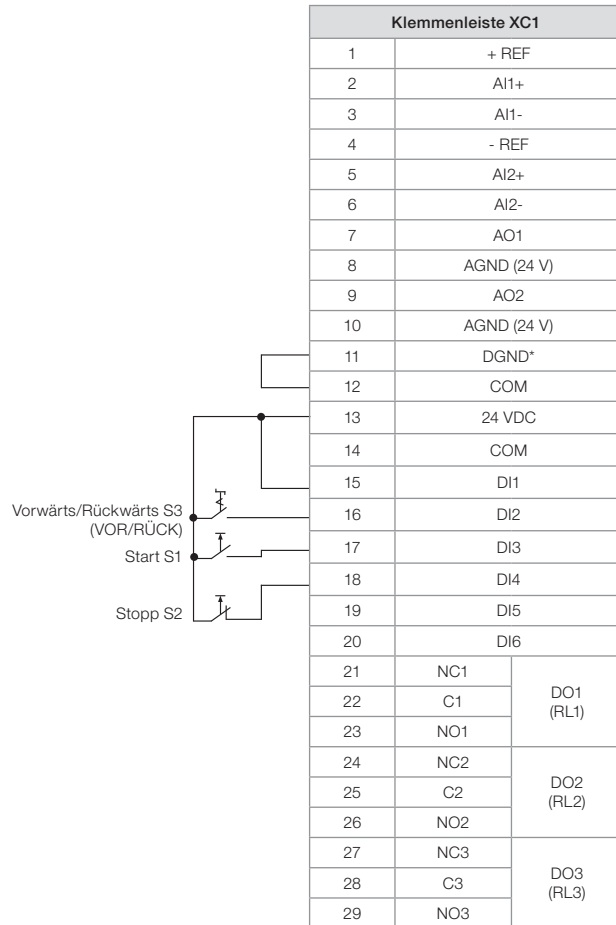
DI3 auf Vorwärts setzen: P0265=4

DI4 auf Rückwärts setzen: P0266=5

Wenn die Vorwärts/Rückwärts-Funktion eingestellt ist, ist sie entweder im Local- oder im Remote-Modus aktiv. Gleichzeitig sind die Tasten und auf dem Bediengerät stets deaktiviert (auch wenn P0224=0 bzw. P0227=0).

Die Drehrichtung wird durch die Vorwärts- und Rückwärts-Eingänge bestimmt.

Im Uhrzeigersinn bei der Vorwärts-Funktion und gegen den Uhrzeigersinn bei der Rückwärts-Funktion.

Die Drehzahlreferenz kann von einer beliebigen Quelle definiert werden (wie bei Steueranschluss 3).



Abb. 25: Verdrahtung von XC1 für Steueranschluss 4

INSTALLATION GEMÄSS EU-RICHTLINIE ÜBER DIE ELEKTROMAGNETISCHE VERTRÄGLICHKEIT

Die Umrichter der Baugröße A bis D mit FA-Option (CFW11XXXXXOFA) sowie alle Standard-Umrichter in den übrigen Baugrößen sind mit einem integrierten RFI-Filter (Funkentstörfilter) zur Unterdrückung elektromagnetischer Störungen ausgerüstet. Sofern diese Umrichter ordnungsgemäß installiert sind, erfüllen sie die Anforderungen zur elektromagnetischen Verträglichkeit gemäß EMV-Richtlinie 2004/108/EG.

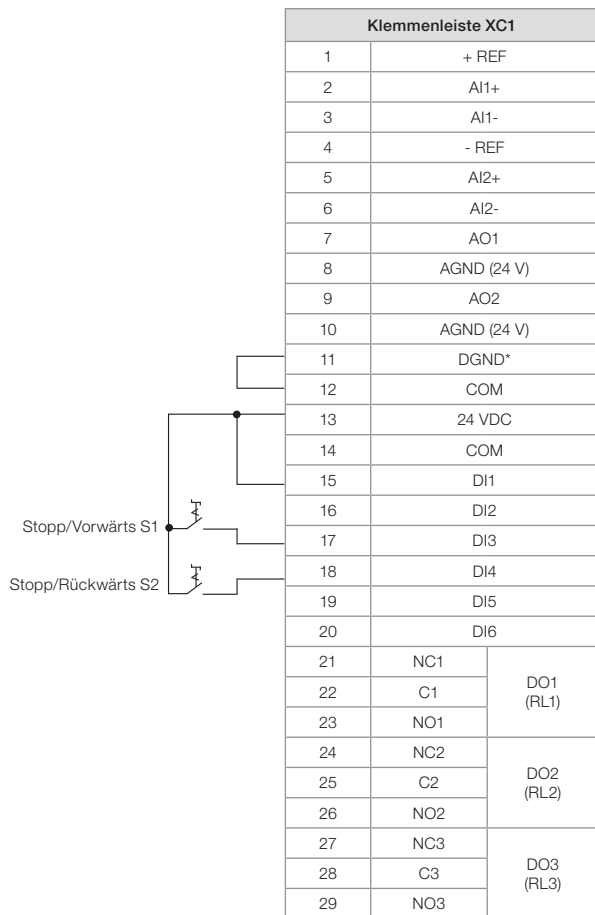

ACHTUNG!

Werden Umrichter mit integrierten RFI-Filtern in IT-Netzen eingesetzt, so sind die Hinweise in [Abb. 17](#) bis [19](#) zu beachten.

Richtlinienkonforme Installation

Folgende Bauteile sind zu verwenden, um eine vorschriftsgemäße Installation des Umrichters zu gewährleisten:

1. Umrichter der Baugröße A bis D: mit integriertem RFI-Filter CFW11XXXXXOFA (Option) und andere Standard-Modelle.
2. Geschirmte Ausgangskabel (Motorkabel): Die Schirmung muss beidseitig (motor- und umrichterseitig) mit einem Niedrigimpedanz-Anschluss für hohe Frequenzen verbunden werden. Bezüglich der maximalen Länge des Motorkabels sowie der Störpegel durch Störspannung und Störstrahlung sind die Angaben in [Tabelle 2](#) und [3](#) zu beachten. Falls ein niedrigerer Störpegel bzw. ein längeres Motorkabel erforderlich ist, muss ein externer RFI-Filter am Umrichtereingang vorgesehen werden. Weitere Informationen (Artikelbezeichnung des RFI-Filters, Länge des Motorkabels sowie Störpegel) sind [Tabelle 2](#) und [3](#) zu entnehmen.
3. Geschirmte Steuerkabel.
4. Starre Erdung des Umrichters.

Tabelle 2: Funkstörspannung und Funkstrahlung bei Baugröße A bis D

Umrichter-Modell (mit eingebautem RFI-Filter)	Ohne externen RFI-Filter			Mit externem RFI-Filter				
	Funkstörspannung – Max. Länge des Motorkabels		Funkstörstrahlung	Externer RFI-Filter Art.-Nr. (Hersteller: EPCOS)		Funkstörspannung – Max. Länge des Motorkabels		Funkstörstrahlung – Kategorie
	Kategorie C3	Kategorie C2		Kategorie C2	Kategorie C1	Ohne Metallgehäuse	In Metallgehäuse eingebaut	
			Kategorie (kein Metallgehäuse erforderlich)					
CFW11 0006 S 2 O FA	100 m	7 m	C2	B84142-A16-R122	75 m	50 m	C2	C2
				B84142-B16-R	100 m	100 m		
CFW11 0007 T 2 O FA	100 m	5 m	C2	B84143-G8-R110	100 m	-	C2	C2
				B84143-A8-R105	50 m	50 m		
CFW11 0007 S 2 O FA	100 m	7 m	C2	B84142-A16-R122	75 m	50 m	C2	C2
				B84142-B16-R	100 m	100 m		
CFW11 0010 S 2 O FA	100 m	7 m	C2	B84142-A30-R122	75 m	50 m	C2	C2
				B84142-B25-R	100 m	100 m		
CFW11 0010 T 2 O FA	100 m	5 m	C2	B84143-G20-R110	100 m	-	C2	C2
				B84143-A16-R105	50 m	50 m		
CFW11 0013 T 2 O FA	100 m	5 m	C2	B84143-G20-R110	100 m	-	C2	C2
				B84143-A16-R105	50 m	50 m		
CFW11 0016 T 2 O FA	100 m	5 m	C2	B84143-G20-R110	100 m	-	C2	C2
				B84143-A25-R105	50 m	50 m		
CFW11 0024 T 2 O FA	100 m	Nein	C2	B84143-A36-R105	100 m	100 m	C2	C2
CFW11 0028 T 2 O FA	100 m	Nein	C2	B84143-A36-R105	100 m	100 m	C2	C2
CFW11 0033 T 2 O FA	100 m	Nein	C2	B84143-A50-R105	100 m	100 m	C2	C2
CFW11 0045 T 2 O FA	100 m	Nein	C3	B84143-A50-R105	100 m	100 m	C3	C2
CFW11 0054 T 2 O FA	100 m	Nein	C3	B84143-A66-R105	100 m	100 m	C3	C2
CFW11 0070 T 2 O FA	100 m	Nein	C3	B84143-A90-R105	100 m	100 m	C3	C2
CFW11 0086 T 2 O FA	100 m	Nein	C3	B84143-A120-R105	100 m	100 m	C3	C2
CFW11 0105 T 2 O FA	100 m	Nein	C3	B84143-A120-R105	100 m	100 m	C3	C2
CFW11 0003 T 4 O FA	100 m	5 m	C2	B84143-G8-R110	100 m	-	C2	C2
				B84143-A8-R105	50 m	50 m		
CFW11 0005 T 4 O FA	100 m	5 m	C2	B84143-G8-R110	100 m	-	C2	C2
				B84143-A8-R105	50 m	50 m		
CFW11 0007 T 4 O FA	100 m	5 m	C2	B84143-G8-R110	100 m	-	C2	C2
				B84143-A8-R105	50 m	50 m		
CFW11 0010 T 4 O FA	100 m	5 m	C2	B84143-G20-R110	100 m	-	C2	C2
				B84143-A16-R105	50 m	50 m		
CFW11 0013 T 4 O FA	100 m	5 m	C2	B84143-G20-R110	100 m	-	C2	C2
				B84143-A16-R105	50 m	50 m		
CFW11 0017 T 4 O FA	100 m	Nein	C2	B84143-A25-R105	100 m	100 m	C2	C2
CFW11 0024 T 4 O FA	100 m	Nein	C2	B84143-A36-R105	100 m	100 m	C2	C2
CFW11 0031 T 4 O FA	100 m	Nein	C2	B84143-A36-R105	100 m	100 m	C2	C2
CFW11 0038 T 4 O FA	100 m	Nein	C3	B84143-A50-R105	100 m	100 m	C3	C2
CFW11 0045 T 4 O FA	100 m	Nein	C3	B84143-A50-R105	100 m	100 m	C3	C2
CFW11 0058 T 4 O FA	100 m	Nein	C3	B84143-A66-R105	100 m	100 m	C3	C2
CFW11 0070 T 4 O FA	100 m	Nein	C3	B84143-A90-R105	100 m	100 m	C3	C2
CFW11 0088 T 4 O FA	100 m	Nein	C3	B84143-A120-R105	100 m	100 m	C3	C2

Tabelle 3: Funkstörspannung und Funkstrahlung bei Baugröße E bis G

Umrichter-Modell (eingebauter RFI-Filter)	Baugröße	Ohne externen RFI-Filter		Mit externem RFI-Filter			
		Funkstörspannung – Max. Länge des Motorkabels	Funkstörstrahlung	Externer RFI-Filter Art.-Nr. – (Hersteller: EPCOS)	Funkstörspannung – Max. Länge des Motorkabels	Funkstörstrahlung – ohne Metallgehäuse	
		Kategorie C3			Kategorie		Kategorie C2
			Kategorie	Kategorie			
CFW11 0142 T2	E	100 m	C2	B84143-B0150-S020	100 m	C2	
CFW11 0180 T2		100 m	C2	B84143-B0180-S020 (1)	100 m	C2	
CFW11 0211 T2		100 m	C2	B84143-B0250-S020 (2)	100 m	C2	
CFW11 0105 T4		100 m	C2	B84143-B0150-S020	100 m	C2	
CFW11 0142 T4		100 m	C2	B84143-B0150-S020	100 m	C2	
CFW11 0180 T4		100 m	C2	B84143-B0180-S020 (1)	100 m	C2	
CFW11 0211 T4		100 m	C2	B84143-B0250-S020 (2)	100 m	C2	
CFW11 0242 T4		100 m	C3 (3)	B84143-B0250-S021	100 m (4)	C3	
CFW11 0312 T4		100 m	C3 (3)	B84143-B01420-S021	100 m (4)	C3	
CFW11 0370 T4		100 m	C3 (3)	B84143-B0400-S021	100 m (4)	C3	
CFW11 0477 T4	F	100 m	C3 (3)	B84143-B0600-S021	100 m (4)	C3	
		100 m	C3 (3)	B84143-B0600-S021	100 m (4)	C3	
CFW11 0515 T4		100 m	C3 (3)	B84143-B0600-S021	100 m (4)	C3	
CFW11 0601 T4		G	100 m	C3 (3)	B84143-B0600-S021	100 m (4)	C3
			100 m	C3 (3)	B84143-B1000-S021	100 m (4)	C3

Anmerkungen zu Tabelle 3:

- (1) Bei einer Umgebungstemperatur von über 40 °C im Bereich des Umrichters/Filterns und einem Dauerausgangsstrom von über 172 A (Effektivwert) muss ein Filter des Typs B84143B0250S020 eingesetzt werden.
- (2) Bei einer Umgebungstemperatur von über 40 °C im Bereich des Umrichters/Filterns und bei Hochlastbetrieb (Ausgangsstrom < 180 A Effektivwert), kann ein Filter des Typs B84143B0180S020 eingesetzt werden.
- (3) Mit Ringkern im Drehstrom-Netzkaabel Beispiel: TDK PN: PC40 UU120x160x20.
- (4) Betriebsfrequenz min. 2,5 Hz.

INTEGRIERTES BEDIENGERÄT – HMI-CFW11

Softkey links: Die Funktion wird im Text direkt oberhalb der Anzeige erläutert.

Softkey rechts: Die Funktion wird im Text direkt oberhalb der Anzeige erläutert.

1. Weiterblättern in den Parametern
2. Drehzahl erhöhen
3. Zurück zur vorherigen Gruppe in der Parametergruppenliste

1. Zurückblättern in den Parametern
2. Drehzahl reduzieren
3. Weiter zur nächsten Gruppe in der Parametergruppenliste

Steuern der Motordrehrichtung
Diese Taste ist aktiv, wenn:
P0223=2 oder 3 auf LOCAL und/oder P0226=2 oder 3 auf REMOTE

Beschleunigt den Motor gemäß Beschleunigungsrampe.
Diese Taste ist aktiv, wenn:
P0224=0 auf LOCAL und/oder P0227=0 auf REMOTE.

Wechsel zwischen LOCAL- und REMOTE-Modus
Diese Taste ist aktiv, wenn:
P0220=2 oder 3

Bremst den Motor gemäß Bremsrampe bis zum Stillstand.
Diese Taste ist aktiv, wenn:
P0224=0 auf LOCAL und/oder P0227=0 auf REMOTE.

Beschleunigt den Motor gemäß Beschleunigungsrampe bis zu der durch P0122 festgelegten Drehzahl.
Die festgelegte Drehzahl bleibt konstant, solange die Taste gedrückt wird.
Beim Loslassen der Taste bremsst der Motor gemäß Bremsrampe bis zum Stillstand.
Diese Taste ist aktiv, wenn folgende Bedingungen erfüllt sind:
1. Start/Stopp=Stopp;
2. Generelle Freigabe=Aktiv;
3. P0225=1 auf LOCAL und/oder P0228=1 auf REMOTE.

Abb. 26: Tasten und Funktionen des Bediengeräts



Abb. 27: Display des Bediengeräts und ab Werk eingestellte Funktionen im Überwachungsmodus (Beispiel)



Abb. 28: Batteriefachabdeckung des Bediengeräts

Hinweise zum Bediengerät

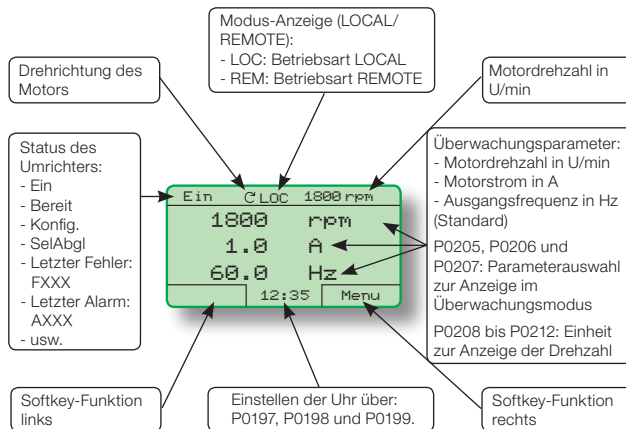
- Das Bediengerät kann unter Spannung ein- und ausgesteckt werden (hot pluggable).
- Im Überwachungsmodus können weitere Anzeigen, wie Balkendiagramme oder Anzeigen mit größeren Zeichensätzen, durch Einstellung der Parameter P0205-207, P0208-212 programmiert werden.
- Die Batterie dient ausschließlich dem Betrieb der internen Uhr, wenn der Umrichter spannungslos ist. Ist die Batterie vollständig entladen oder ist keine Batterie im Bediengerät eingelegt, wird eine ungültige Uhrzeit angezeigt. In diesem Fall erscheint die Alarmmeldung „A181 – Uhrzeit ungültig“ bei jedem Einschalten des Umrichters.
- Batterien dürfen nach Ablauf ihrer Lebensdauer nicht über den Hausmüll entsorgt werden, sondern sind an den entsprechenden Batteriesammelstellen abzugeben.

PARAMETERSTRUKTUR

Bei Betätigung des rechten Softkeys („MENU“) erscheinen in der Anzeige die ersten Parametergruppen. Anzahl und Name der Parametergruppen richten sich nach der jeweiligen Firmware-Version.

INBETRIEBNAHME

GEFAHR!
Der Anschluss der Eingangsspannungsversorgung an die Ausgangsklemmen führt zu einer Beschädigung des Frequenzumrichters.

VORBEREITUNG ZUR INBETRIEBNAHME

- 1) Prüfen Sie, ob die Leistungs-, Erdungs- und Steueranschlüsse ordnungsgemäß und sicher hergestellt wurden.
- 2) Vergewissern Sie sich, dass alle zur Installation verwendeten Gegenstände aus dem Umrichter bzw. Gehäuse entfernt wurden.
- 3) Prüfen Sie die Motoranschlüsse und achten Sie darauf, dass sämtliche Spannungs- und Stromwerte den Nennwerten des Umrichters entsprechen.
- 4) Entkoppeln Sie den Motor von der Last. Falls dies nicht möglich ist, vergewissern Sie sich, dass durch die gewählte Drehrichtung (vorwärts oder rückwärts) weder Personen- noch Sachschäden entstehen können.
- 5) Schließen Sie die Abdeckungen am Umrichter bzw. Gehäuse.
- 6) Messen Sie die Versorgungsspannung und prüfen Sie, ob sie innerhalb des zulässigen Bereichs liegt.
- 7) Stellen Sie die Stromversorgung am Eingang her. Schließen Sie den Eingangstrennschalter.
- 8) Prüfen Sie, ob die Erstinbetriebnahme erfolgreich durchgeführt wurde: Auf dem Display des Bediengeräts sollte der Standard-Überwachungsmodus angezeigt werden. Dabei sollte die Status-LED dauerhaft grün leuchten.

INBETRIEBNAHME IM U/F-MODUS

Die Inbetriebnahme im U/f-Modus wird in drei einfachen Schritten beschrieben. Hierzu gehören die Parametergruppen für die **Geführte Inbetriebnahme** und die **Basisanwendung**.

1) P0000 Passworteinstellung

Schritt	Aktion/Ergebnis	Anzeige
1	- Überwachungsmodus - Taste „Menü“ drücken. (Softkey rechts).	Bereit C'LOC 0 rpm 0 rpm 0.0 A 0.0 Hz 15:45 Menu
2	- Die Gruppe „00 ALLE PARAMETER“ ist bereits ausgewählt. - Taste „Ausw.“ drücken.	Bereit C'LOC 0 rpm 00 ALLE PARAMETER 01 PARAMETERGRUPPEN 02 GEFUHRTE INBETRIEBNAHME 03 GEAND. PARAMETER Zurück 15:45 Ausw.
3	- Der Parameter „Parameterzugriff P0000: 0“ ist bereits ausgewählt. - Taste „Ausw.“ drücken.	Bereit C'LOC 0 rpm Parameterzugriff P0000: 0 Drehzahlsollwert P0001: 90 rpm Zurück 15:45 Ausw.
4	- Zum Einstellen des Passworts drücken, bis die Zahl 5 angezeigt wird.	Bereit C'LOC 0 rpm P0000 Parameterzugriff 5 Zurück 15:45 Speich
5	- Wenn die Zahl 5 angezeigt wird, Taste „Speich“ drücken.	Bereit C'LOC 0 rpm P0000 Parameterzugriff 5 Zurück 15:45 Speich
6	- Bei korrekter Einstellung muss folgende Anzeige erscheinen: „Parameterzugriff P0000: 5“. - Taste „Zurück“ drücken (Softkey links).	Bereit C'LOC 0 rpm Parameterzugriff P0000: 5 Drehzahlsollwert P0001: 90 rpm Zurück 15:45 Ausw.
7	- Taste „Zurück“ drücken.	Bereit C'LOC 0 rpm 00 ALLE PARAMETER 01 PARAMETERGRUPPEN 02 GEFUHRTE INBETRIEBNAHME 03 GEAND. PARAMETER Zurück 15:45 Ausw.
8	- Die Anzeige schaltet in den Überwachungsmodus zurück.	Bereit C'LOC 0 rpm 0 rpm 0.0 A 0.0 Hz 15:45 Menu

Abb. 29: Ändern der Parametrierung über P0000

2) Geführte Inbetriebnahme

Die Parametergruppe „Geführte Inbetriebnahme“ erleichtert die Einstellung des Umrichters. Über den Parameter P0317 in dieser Parametergruppe kann die geführte Inbetriebnahmesequenz eingegeben werden.

Diese Sequenz zeigt die wichtigsten Parameter in einer logischen Reihenfolge am Bediengerät an. Es werden die für einen ordnungsgemäßen Betrieb des Umrichters erforderlichen Parameter eingestellt. Daten wie Netzspannung sowie die Typenschilddaten des Motors werden eingegeben.

Zum Starten der geführten Inbetriebnahme setzen Sie zunächst Parameter P0317 auf 1. Für alle übrigen Parametrierungen folgen Sie den Anweisungen auf dem Display.

Die während der geführten Inbetriebnahme vorgenommenen Parametrierungen ändern automatisch andere Parameter und/oder interne Variablen des Umrichters.

Während der geführten Inbetriebnahme erscheint die Meldung „Konfig“ links oben im Display des Bediengeräts (HMI).

3) Parametrierungen der Basisanwendung

Nachdem die geführte Inbetriebnahme mit allen Parametrierungen ordnungsgemäß durchgeführt wurde, steht der Umrichter für den U/f-Betrieb bereit.

Die Parametergruppe in der Basisanwendung umfasst die gängigeren Anwendungsparameter.

DATUM UND UHRZEIT EINSTELLEN

Wählen Sie die Parametergruppe HMI und nehmen Sie folgende Änderungen vor: Tag (P0194), Monat (P0195) und Jahr (P0196); Uhrzeit: Stunde (P0197), Minuten (P0198) und Sekunden (P0199).

SCHUTZ VOR UNZULÄSSIGEN PARAMETERÄNDERUNGEN

Um unberechtigten oder versehentlichen Parameteränderungen vorzubeugen, kann P0000 auf einen Wert ungleich 5 gesetzt werden.

FUNKTIONEN DES FLASH-SPEICHERMODULS

- Speichern Sie eine Kopie der Umrichter-Parameter.
- Übertragen Sie die Parameter aus dem FLASH-Speicher in den Umrichter.
- Übertragen Sie die Firmware aus dem FLASH-Speicher in den Umrichter.
- Speichern Sie das Programm, das Sie mit der SoftPLC erstellt haben.

Bei jedem Einschalten des Umrichters wird dieses Programm (SoftPLC) in den RAM-Speicher auf der Steuerkarte des Umrichters übertragen und ausgeführt.

Weitere Informationen hierzu entnehmen Sie bitte dem Programmierhandbuch des CFW-11 und dem Handbuch zur SoftPLC.

Tabelle A.2: Technische Daten der Baugrößen E bis G

Modell	Baugröße	Anzahl der Stromphasen	Einsatz bei Normalbetrieb (ND)						Einsatz bei Hochlastbetrieb (HD)						Sicherung I ^{2t} [A ² s] bei 25 °C	Sicherung [A] gemäß europäischer IEC-Norm	Umgebungstemperatur [°C]	Dynamisches Bremsen	Schutzart durch Gehäuse	RFI-Filter	Sicherer Halt	24 VDC externe Steuerspannungsversorgung	Verfügbarkeit von Optionsbausätzen für das Produkt												
			Nennausgangsstrom ⁽¹⁾ [Aeff.]	Überlaststrom ⁽²⁾ [Aeff.]	Nennträgerfrequenz [kHz]	Motorleistung max. [kW]	Nenneingangsstrom [Aeff.]	Verlustleistung [W]	Wand-Flanschmontage	Nennausgangsstrom ⁽¹⁾ [Aeff.]	Überlaststrom ⁽²⁾ [Aeff.]	Nennträgerfrequenz [kHz]	Motorleistung max. [kW]	Nenneingangsstrom [Aeff.]										Verlustleistung [W]	Wand-Flanschmontage	1 min	3 s	1 min	3 s	1 min	3 s	1 min	3 s	1 min	3 s
CFW11 0142 T 2	E	3ø	142	156.2	213	2.5	50/37	142	1490	210	115	172.5	230	5	40/30	115	1280	200	64.0 (141.1)	200	39200	-10... 45 (14... 113)	Option (Standardausführung ohne dynamisches Bremsen)	Nema 1 (KNIE-01 Set)	Ja	Ja	integriert	integriert	IP20	IP20	IP20	IP20	IP20	IP20	
CFW11 0180 T 2		3ø	180	198	270	2.5	60/45	180	1820	360	142	213	284	5	50/37	142	1550	350	65.0 (143.3)	200	218000	-10... 45 (14... 113)	Option (Standardausführung ohne dynamisches Bremsen)	Nema 1 (KNIE-02 Set)											
CFW11 0211 T 2		3ø	211	232	317	2.5	75/65	211	2040	360	180	270	360	2.5	75/55	180	1690	350	65.0 (143.3)	250	218000	-10... 45 (14... 113)	Option (Standardausführung ohne dynamisches Bremsen)	Nema 1 (KNIE-01 Set)											
CFW11 0105 T 4		3ø	105	115.5	157.5	2.5	75/65	105	1270	200	88	132	176	2.5	60/45	88	1020	190	62.5 (137.8)	125	39200	-10... 45 (14... 113)	Option (Standardausführung ohne dynamisches Bremsen)	Nema 1 (KNIE-01 Set)											
CFW11 0142 T 4		3ø	142	156.2	213	2.5	100/75	142	1680	210	115	172.5	230	2.5	75/55	115	1290	200	64.0 (141.1)	200	39200	-10... 45 (14... 113)	Option (Standardausführung ohne dynamisches Bremsen)	Nema 1 (KNIE-02 Set)											
CFW11 0180 T 4		3ø	180	198	270	2.5	150/110	180	2050	360	142	213	284	2.5	100/75	142	1570	350	65.0 (143.3)	200	218000	-10... 45 (14... 113)	Option (Standardausführung ohne dynamisches Bremsen)	Nema 1 (KNIE-02 Set)											
CFW11 0211 T 4		3ø	211	232.1	317	2.5	175/132	211	2330	360	180	270	360	2.5	150/110	180	1940	350	65.0 (143.3)	250	218000	-10... 45 (14... 113)	Option (Standardausführung ohne dynamisches Bremsen)	Nema 1 (KNIE-01 Set)											
CFW11 0242 T 4		3ø	242	266	363	2.5	200/150	242	1518	285	211	317	422	2.5	175/132	211	1277	227	130 (286.6)	315	320000	-10... 45 (14... 113)	Option (Standardausführung ohne dynamisches Bremsen)	Nema 1 (KNIE-02 Set)											
CFW11 0312 T 4		F	3ø	312	343	468	2.5	250/185	312	2034	375	242	363	484	2.5	200/150	242	1507	292	132 (291.0)	500	414000	-10... 45 (14... 113)	Option (Standardausführung ohne dynamisches Bremsen)											Nema 1 (KNIE-01 Set)
CFW11 0370 T 4			3ø	370	407	555	2.5	300/220	370	2497	407	312	468	624	2.5	250/185	312	2008	320	135 (297.6)	500	414000	-10... 45 (14... 113)	Option (Standardausführung ohne dynamisches Bremsen)											Nema 1 (KNIE-02 Set)
CFW11 0477 T 4			3ø	477	525	716	2.5	400/300	477	3273	595	370	555	740	2.5	300/220	370	2451	465	140 (308.6)	700	1051000	-10... 45 (14... 113)	Option (Standardausführung ohne dynamisches Bremsen)											Nema 1 (KNIE-01 Set)
CFW11 0515 T 4			3ø	515	567	773	2	400/300	515	3338	769	477	716	954	2	400/300	477	2987	644	204 (449.7)	900	1445000	-10... 45 (14... 113)	Option (Standardausführung ohne dynamisches Bremsen)											Nema 1 (KNIE-02 Set)
CFW11 0601 T 4	3ø		601	662	900	2	500/370	601	3875	781	515	773	1030	2	400/300	515	3219	639	207 (456.4)	900	1445000	-10... 45 (14... 113)	Option (Standardausführung ohne dynamisches Bremsen)	Nema 1 (KNIE-01 Set)											
CFW11 0720 T 4	3ø		720	792	1080	2	600/440	720	4576	858	560	840	1120	2	450/330	560	3747	653	215 (474.0)	1100	1445000	-10... 40 (14... 104)	Option (Standardausführung ohne dynamisches Bremsen)	Nema 1 (KNIE-02 Set)											
Modelle mit 380 bis 440 V Stromversorgung																																			

Hinweise:
 (1) Dauernennstrom unter folgenden Bedingungen:
 - Angegebene Schaltfrequenzen;
 - Umgebungstemperatur gemäß Tabelle. Bei höheren Temperaturen (maximal 10 °C über der für die Nennbetriebsbedingungen geltenden Höchsttemperatur) muss der Ausgangsstrom um 2 % pro °C, das die angegebene Höchsttemperatur übersteigt, reduziert werden.

(2) Die angegebenen Motornennströme sind lediglich Richtwerte für 230 V bzw. 460 V vierpolige WEG-Motoren. Die Baugröße des Frequenzumrichters muss abhängig vom tatsächlichen Motornennstrom ausgewählt werden.

- Relative Luftfeuchtigkeit: 5 % bis 90 %, nicht kondensierend;
 - Aufstellungshöhe: 1000 m. Bei einer Aufstellungshöhe über 1000 m muss der Ausgangsstrom um 1 % für jede 100 m, die über 1000 m liegen, reduziert werden.
 - Umgebungen mit Verschmutzungsgrad 2 (gemäß EN 50178 und UL 508C).

Tabelle A.3: Technische Daten zum dynamischen Bremsen bei Baugrößen A bis E

Umrichter-Modell	Bremsstrom max. (I _{max}) [A]	Bremsleistung max. (Spitzenleistung) (P _{max}) ⁽²⁾ [kW]	Effektiver Bremsstrom (I _{effektiv}) ⁽¹⁾ [A]	Verlustleistung (Mittelwert) im Bremswiderstand (P _R) ⁽²⁾ [kW]	Empfohlener Widerstand [Ω]	Leistungsaderquerschnitt (Klemmen DC+ und BR) [mm ² (AWG)]
CFW11 0006 B 2	5.3	2.1	5.2	2.03	75	1.5 (16)
CFW11 0006 S 2 O FA	5.3	2.1	5.2	2.03	75	1.5 (16)
CFW11 0007 B 2	7.1	2.9	6.96	2.71	56	1.5 (16)
CFW11 0007 S 2 O FA	7.1	2.9	6.96	2.71	56	1.5 (16)
CFW11 0007 T 2	5.3	2.1	5.2	2.03	75	1.5 (16)
CFW11 0010 S 2	11.1	4.4	10.83	4.22	36	2.5 (14)
CFW11 0010 T 2	7.1	2.9	6.96	2.71	56	1.5 (16)
CFW11 0013 T 2	11.1	4.4	8.54	2.62	36	2.5 (14)
CFW11 0016 T 2	14.8	5.9	14.44	5.63	27	4 (12)
CFW11 0024 T 2	26.7	10.7	19.15	5.5	15	6 (10)
CFW11 0028 T 2	26.7	10.7	18.21	4.97	15	6 (10)
CFW11 0033 T 2	26.7	10.7	16.71	4.19	15	6 (10)
CFW11 0045 T 2	44	17.6	33.29	10.1	9.1	10 (8)
CFW11 0054 T 2	48.8	19.5	32.17	8.49	8.2	10 (8)
CFW11 0070 T 2	48.8	19.5	26.13	5.6	8.2	6 (8)
CFW11 0086 T 2	93	37.2	90.67	35.3	4.3	35 (2)
CFW11 0105 T 2	111.1	44.4	90.87	29.7	3.6	35 (2)
CFW11 0003 T 4	3.6	2.9	3.54	2.76	220	1.5 (16)
CFW11 0005 T 4	5.3	4.3	5.2	4.05	150	1.5 (16)
CFW11 0007 T 4	5.3	4.3	5.2	4.05	150	1.5 (16)
CFW11 0010 T 4	8.8	7	8.57	6.68	91	2.5 (14)
CFW11 0013 T 4	10.7	8.5	10.4	8.11	75	2.5 (14)
CFW11 0017 T 4	12.9	10.3	12.58	9.81	62	2.5 (12)
CFW11 0024 T 4	17	13.6	16.59	12.9	47	4 (10)
CFW11 0031 T 4	26.7	21.3	20.49	12.6	30	6 (10)
CFW11 0038 T 4	36.4	29.1	26.06	14.9	22	6 (8)
CFW11 0045 T 4	47.1	37.6	40	27.2	17	10 (8)
CFW11 0058 T 4	53.3	42.7	31.71	15.1	15	10 (8)
CFW11 0070 T 4	66.7	53.3	42.87	22.1	12	10 (6)
CFW11 0088 T 4	87.9	70.3	63.08	36.2	9.1	25 (4)
CFW11 0142 T 2 O DB	266.7	106.7	142	30.2	1.5	70 (2/0) oder 2 x 25 (2 x 4)
CFW11 0180 T 2 O DB	266.7	106.7	180	48.6	1.5	120 (4/0) oder 2 x 35 (2 x 2)
CFW11 0211 T 2 O DB	333.3	133.3	211	53.4	1.2	150 (300) oder 2 x 50 (2 x 1)
CFW11 0105 T 4 O DB	186	148.8	105	47.4	4.3	50 (1)
CFW11 0142 T 4 O DB	266.7	213.3	142	60.5	3	70 (2/0) oder 2 x 25 (2 x 4)
CFW11 0180 T 4 O DB	266.7	213.3	180	97.2	3	120 (4/0) oder 2 x 35 (2 x 2)
CFW11 0211 T 4 O DB	363.6	290.9	191.7	80.8	2.2	120 (250) oder 2 x 50 (2 x 1)

Hinweise:

(1) Bei dem angegebenen effektiven Bremsstrom handelt es sich lediglich um einen Anhaltswert. Der tatsächliche effektive Bremsstrom richtet sich nach der Bremsdauer. Der effektive Bremsstrom lässt sich anhand folgender Formel berechnen. Dabei entspricht der in Minuten angegebene Wert t_{br} der Summe aller Bremszeiten während einer fünfminütigen Einschaltdauer.

$$I_{\text{effektiv}} = I_{\text{max}} \cdot \sqrt{\frac{t_{\text{br}}}{5}}$$

(2) Die angegebenen Werte P_{max} und P_R (maximale bzw. mittlere Leistung des Bremswiderstands) gelten für die empfohlenen Bremswiderstände sowie für die in der Tabelle aufgeführten effektiven Bremsströme. Die Leistung des Bremswiderstands muss je nach Bremsdauer geändert werden.



Variateur de Vitesse

Manuel d'installation

Série: CFW-11

Langue: Français

Document: 10001803811 / 00

Date de Publication: 01/2013

FRANÇAIS

РУССКИЙ

NEDERLANDS

ITALIANO

TABLE DES MATIÈRES

A PROPOS DE CE MANUEL.....	87
CONSIGNES DE SÉCURITÉ	87
CFW-11 - DESCRIPTION GÉNÉRALE	87
RÉCEPTION - STOCKAGE.....	87
INSTALLATION MÉCANIQUE	87
MONTAGE - GÉNÉRALITÉS	87
MONTAGE DU BOÎTIER	87
INSTALLATION ÉLECTRIQUE.....	90
SCHÉMAS DE CÂBLAGE.....	90
REMARQUES SUR LES CIRCUITS ET LES APPAREILS	91
RÉSEAUX INFORMATIQUES	92
RACCORDEMENTS À LA TERRE.....	92
CONNEXIONS DES CÂBLES DE COMMANDE	93
INSTALLATION CONFORME À LA DIRECTIVE EUROPÉENNE DE COMPATIBILITÉ ÉLECTROMAGNÉTIQUE.....	95
CLAVIER INTÉGRÉ - HMI-CFW11	96
STRUCTURE DES PARAMÈTRES.....	97
DÉMARRAGE	97
AVANT DE METTRE SOUS TENSION	97
DÉMARRAGE EN MODE V/F	97
RÉGLAGE DE LA DATE ET DE L'HEURE	98
BLOCAGE DE LA MODIFICATION DES PARAMÈTRES.....	98
FONCTIONS DU MODULE MÉMOIRE FLASH.....	98
ANNEXE 1 – CARACTÉRISTIQUES TECHNIQUES.....	99

A PROPOS DE CE MANUEL

Ce manuel explique comment installer et mettre en service en mode V/f les variateurs CFW-11 modèles A à G.

Pour en savoir plus, veuillez vous reporter au Manuel d'utilisation et au Manuel de programmation du variateur CFW-11.

Le variateur CFW-11 est également utilisable dans les modes suivants : VVW, régulation vectorielle sans capteur et régulation vectorielle avec encodeur pour les moteurs asynchrones ; régulation vectorielle sans capteur et avec encodeur pour les machines à aimant permanent (PM). (Voir le Manuel de programmation).

Pour plus d'informations sur les fonctions, les accessoires et les communications, vous pouvez télécharger des manuels sur le site web WEG www.weg.net.

CONSIGNES DE SÉCURITÉ

Lisez attentivement ce manuel avant d'installer ou d'utiliser le variateur.

Seul du personnel qualifié et compétent peut utiliser, mettre en service et dépanner ce type d'appareil. Ces personnes doivent respecter toutes les consignes de sécurité figurant dans ce manuel et/ou imposées par les réglementations locales.



DANGER !

Le manquement à ces consignes de sécurité peut entraîner la mort, des blessures graves et des dommages matériels.

Déconnectez toujours l'alimentation principale avant d'entrer en contact avec un appareil électrique associé au variateur.

Plusieurs composants peuvent rester chargés à un potentiel électrique élevé et/ou être en mouvement (ventilateurs), même après la déconnexion ou la coupure de l'alimentation en courant alternatif.

Attendez au moins 10 minutes que les condensateurs se déchargent complètement.

Raccordez toujours la masse de l'appareil à une terre protectrice (PE).



REMARQUE !

Dans le cadre de ce manuel, le personnel est considéré comme qualifié s'il a été formé et peut :

1. Installer, raccorder à la terre, mettre sous tension et utiliser le variateur conformément aux consignes de ce manuel et aux procédures légales de sécurité.
2. Utiliser le matériel de protection conformément aux réglementations en vigueur.
3. Apporter les premiers soins.



REMARQUE !

Un variateur de fréquence peut créer des interférences et des parasites avec d'autres appareils électroniques. Respectez les instructions d'installation pour minimiser ces effets.

CFW-11 - DESCRIPTION GÉNÉRALE

La gamme des variateurs de fréquence CFW-11 comporte des modèles performants de puissance comprise entre 0,75 et 450 kW en 7 tailles différentes et fonctionnant sur une tension secteur de 200 V à 480 V. Il régule la vitesse et le couple des moteurs asynchrones triphasés et à aimant permanent. La principale caractéristique de ce produit est la technologie "Vectrue" qui offre les modes de régulation suivants : régulation scalaire (V/f), VVW, "régulation vectorielle sans capteur" et "régulation vectorielle avec encodeur". Autres fonctions et caractéristiques : "Freinage optimal", "Réglage automatique" et "Flux optimal".

Pour en savoir plus, veuillez vous reporter au Manuel d'utilisation et au Manuel de programmation du variateur CFW-11.

RÉCEPTION - STOCKAGE

À la réception du produit, vérifiez que :

La plaque signalétique du variateur CFW-11 correspond au modèle indiqué sur le bon de commande. Voir les modèles et les caractéristiques dans les [tableaux A.1](#) et [A.2](#).

Le produit n'a pas été endommagé pendant le transport. Si vous constatez un problème, contactez immédiatement le transporteur.

Si vous n'installez pas immédiatement le variateur CFW-11, stockez-le dans son emballage d'origine dans un endroit propre et sec (température comprise entre -25 °C et 60 °C).

INSTALLATION MÉCANIQUE

ENVIRONNEMENT

Évitez :

- l'exposition directe au soleil, à la pluie, dans un milieu humide et à l'air marin.
- la présence de gaz ou de liquides corrosifs.
- des vibrations excessives.
- les poussières, les particules métalliques et les vapeurs d'huile.
- Environnement conforme aux [tableaux A.1](#) et [A.2](#).

MONTAGE - GÉNÉRALITÉS

Les [tableaux A.1](#) et [A.2](#) indiquent les poids des divers modèles.

Montez le variateur en position verticale sur une surface verticale plane.

Cotes extérieures et la position des trous : voir [figure 1](#).

Les espaces libres et dégagés pour la circulation correcte de l'air de refroidissement sont indiqués [figure 2](#).

Remarque :

- Pour les tailles A, B et C : montage côte à côte - pas d'espace libre nécessaire entre les variateurs si le capot supérieur est enlevé.

Ne placez pas de composants sensibles à la chaleur au-dessus du variateur.

MONTAGE DU BOÎTIER

Surface de montage :

Prévoyez suffisamment d'espace de façon que la température interne du variateur reste dans les tolérances de fonctionnement autorisées.

La puissance dissipée par le variateur dans ses conditions d'utilisation nominales est indiquée dans les [tableaux A.1](#) et [A.2](#) "Puissance dissipée en Watts – Montage sur platine".

Le débit minimal de l'air de refroidissement du boîtier est indiqué au [tableau 1](#).

La position et le diamètre des trous de fixation sont indiqués figure 1.

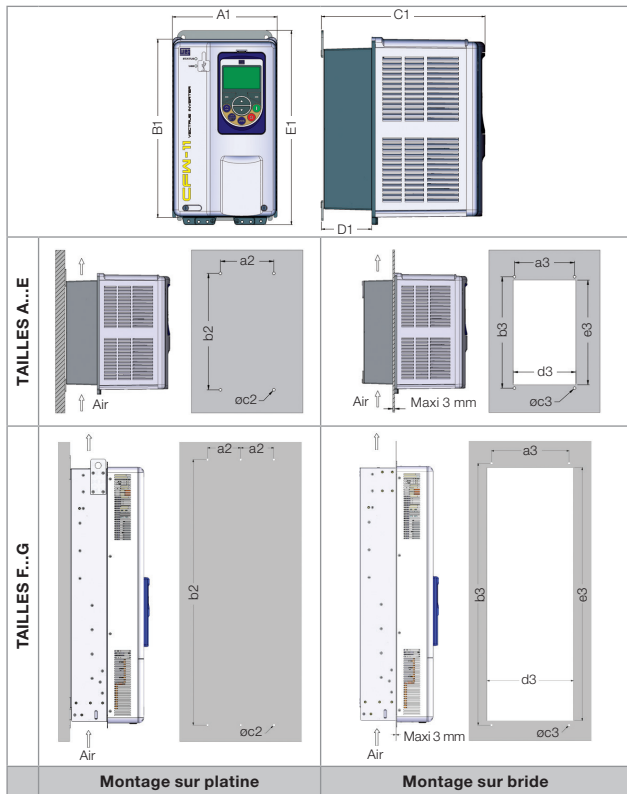

Modèle	A1	B1	C1	D1	E1	a2	b2	c2	a3	b3	c3	d3	e3
	mm (pouces)	mm (pouces)	mm (pouces)	mm (pouces)	mm (pouces)	mm (pouces)	mm (pouces)	M	mm (pouces)	mm (pouces)	M	mm (pouces)	mm (pouces)
Taille A	145 (5.71)	247 (9.73)	227 (8.94)	70 (2.75)	270 (10.63)	115 (4.53)	250 (9.85)	M5	130 (5.12)	240 (9.45)	M5	135 (5.32)	225 (8.86)
Taille B	190 (7.48)	293 (11.53)	227 (8.94)	71 (2.78)	316 (12.43)	150 (5.91)	300 (11.82)	M5	175 (6.89)	285 (11.23)	M5	179 (7.05)	271 (10.66)
Taille C	220 (8.67)	378 (14.88)	293 (11.53)	136 (5.36)	405 (15.95)	150 (5.91)	375 (14.77)	M6	195 (7.68)	365 (14.38)	M6	205 (8.08)	345 (13.59)
Taille D	300 (11.81)	504 (19.84)	305 (12.00)	135 (5.32)	550 (21.65)	200 (7.88)	525 (20.67)	M8	275 (10.83)	517 (20.36)	M8	285 (11.23)	485 (19.10)
Taille E	335 (13.19)	620 (24.41)	358 (14.09)	168 (6.61)	675 (26.57)	200 (7.88)	650 (25.59)	M8	275 (10.83)	635 (25.00)	M8	315 (12.40)	615 (24.21)
Taille F	430 (16.93)	1156 (45.51)	360 (14.17)	169 (6.65)	1234 (48.58)	150 (5.91)	1200 (47.24)	M10	350 (13.78)	1185 (46.65)	M10	391 (15.39)	1146 (45.12)
Taille G	535 (21.06)	1190 (46.85)	426 (16.77)	202 (7.95)	1264 (49.76)	200 (7.87)	1225 (48.23)	M10	400 (15.75)	1220 (48.03)	M10	495 (19.49)	1182 (46.53)

Tolérance pour d3 et e3 : +1.0 mm
Tolérance générale : ±1.0 mm

Figure 1 : détails d'installation mécanique

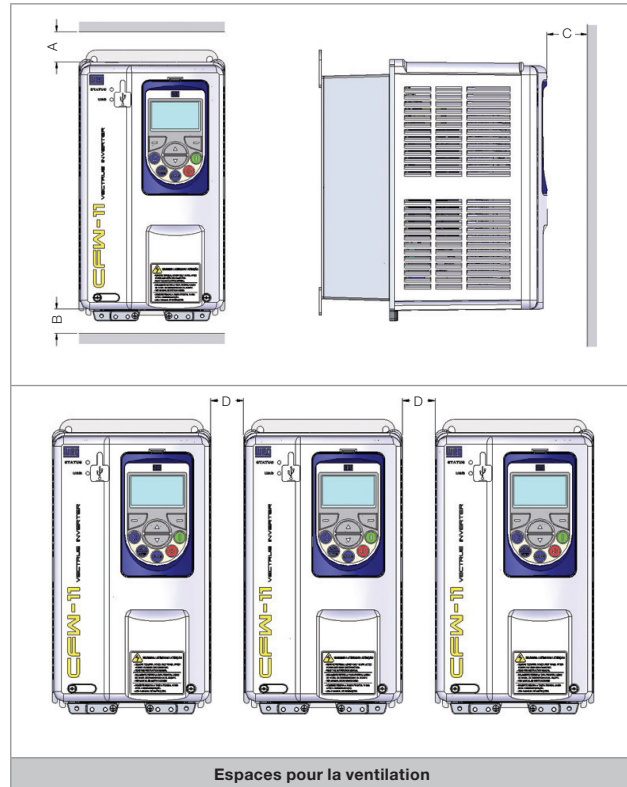

Modèle	A	B	C	D			
	mm (pouces)	mm (pouces)	mm (pouces)	mm (pouces)			
Taille A	25 (0.98)	25 (0.98)	10 (0.39)	30 (1.18)			
Taille B	40 (1.57)	45 (1.77)					
Taille C	110 (4.33)	130 (5.12)	20 (0.78)	80 (3.15)			
Taille D	100 (3.94)	130 (5.12)					
Taille E					0142 T2	150 (5.91)	250 (9.84)
					0211 T2	100 (3.94)	130 (5.12)
					0105 T4	150 (5.91)	250 (9.84)
					0180 T4		
			0211 T4				
Taille F							
Taille G							

Tolérance : ±1.0 mm

Figure 2 : Espace minimal de ventilation du variateur

Tableau 1 : Débit minimal de l'air de refroidissement

Châssis	Modèle	CFM	l/s	m³/min
A	TOUS	18	8	0.5
B	TOUS	42	20	1.2
C	TOUS	96	45	2.7
D	TOUS	132	62	3.7
E	CFW11 0142 T 2	138	65	3.9
	CFW11 0180 T 2	265	125	7.5
	CFW11 0211 T 2			
	CFW11 0105 T 4	138	65	3.9
	CFW11 0142 T 4	180	95	5.1
	CFW11 0180 T 4	265	125	7.5
CFW11 0211 T 4				
F	CFW11 0242 T 4	250	118	7.1
	CFW11 0312 T 4	320	151	9.1
	CFW11 0370 T 4	380	180	10.1
	CFW11 0477 T 4	460	217	13
G	CFW11 0515 T 4	680	321	19.3
	CFW11 0601 T 4			
	CFW11 0720 T 4			

Montage sur bride :

Les pertes indiquées aux [tableaux A.1 et A.2](#) "Puissance dissipée en Watts – Montage sur bride" se dissipent à l'intérieur du boîtier. Les autres pertes sont dissipées par l'arrière.

Les supports de fixation et les œillets de levage du variateur doivent être démontés et repositionnés pour les tailles E, F et G. Voir les [figures 3 et 4](#).

La partie du variateur à l'extérieur du boîtier est classée IP54 pour les châssis A à E. Pour les châssis F et G, la protection est classée IP20.

Utilisez un joint adéquat sur l'ouverture du boîtier pour garantir que la classe de protection est conservée. Exemple : joint de silicone.

Cotes de montage et positions et diamètres des trous de fixation : voir [figure 1](#).

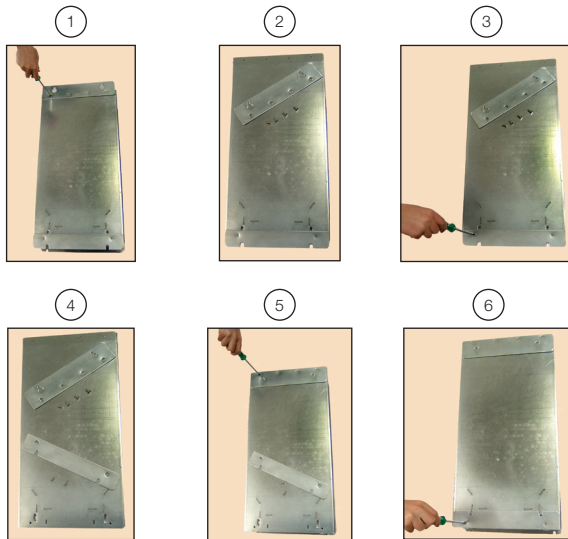

Figure 3 : Repositionnement des supports de fixation pour les tailles A à E. Pour les tailles F et G, les supports de fixation doivent être démontés.

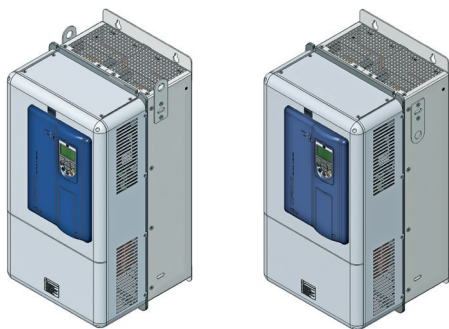

Figure 4 : Montage des œillets de levage – Tailles E, F et G

Accès aux bornes de commande et d'alimentation

Pour accéder aux bornes de commande et d'alimentation, il est nécessaire de déposer le capot du pupitre opérateur et des commandes pour les tailles A à C. Voir [figure 5](#).

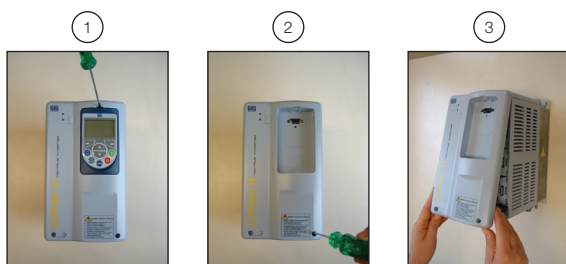

Figure 5 : Dépose du capot du pupitre opérateur et des commandes

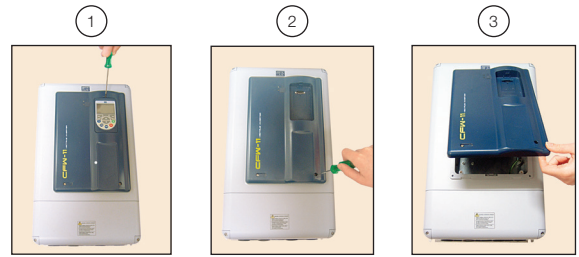

Figure 6 : Dépose du capot du pupitre opérateur et du rack de commande pour les tailles D, E, F et G pour accéder aux bornes de commande

Pour accéder aux bornes d'alimentation, il est nécessaire de déposer le capot avant inférieur (voir [figure 7](#)) pour les tailles D à G.

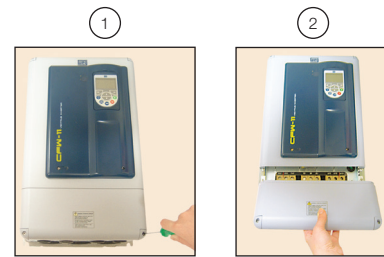

Figure 7 : Dépose du capot avant inférieur pour accéder aux bornes d'alimentation (tailles D à G)

Lorsque les classes de protection IP20 ou Nema1 ne sont pas nécessaires, il est possible d'enlever la plaque inférieure de passage des câbles pour les tailles D et E.

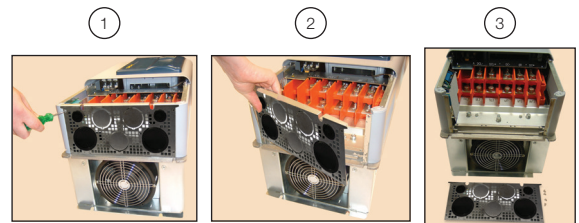

Figure 8 : Dépose de la plaque de passage des câbles

Pour les tailles F et G, déposez toujours la plaque inférieure de connexion des câbles (secteur et moteur) : voir [figure 9](#).

Dans ce cas, la classe de protection de la partie inférieure du variateur peut être dégradée.

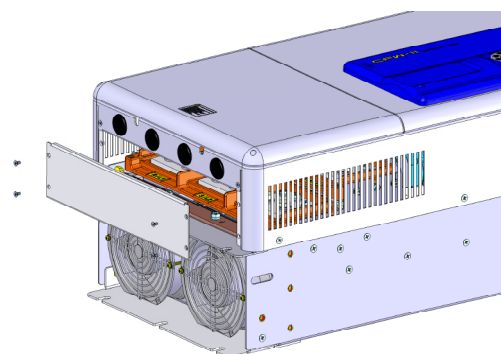

Figure 9 : Dépose de la plaque de passage des câbles pour les tailles F et G

INSTALLATION ÉLECTRIQUE

DANGER !
Vérifiez que l'alimentation secteur CA est débranchée avant de commencer l'installation.

DANGER !
Les informations suivantes constituent uniquement un guide pour une installation correcte. Respectez les réglementations locales en vigueur pour les installations électriques.

DANGER !
Le variateur sera détérioré si l'alimentation est connectée aux bornes de sortie.

SCHÉMAS DE CÂBLAGE

Remarques :

Les caractéristiques techniques, y compris les fusibles, figurent aux tableaux A.1 et A.2.

Caractéristiques techniques des résistances et des courants de freinage : voir tableau A.3.

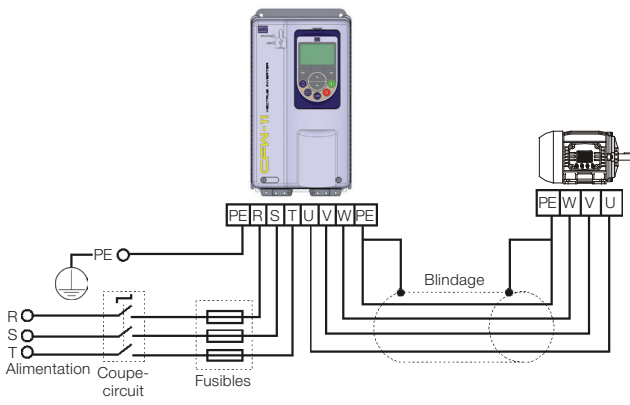

Figure 10 : Schéma de connexion de l'alimentation pour les châssis standard A, B, C, D, E, F et G

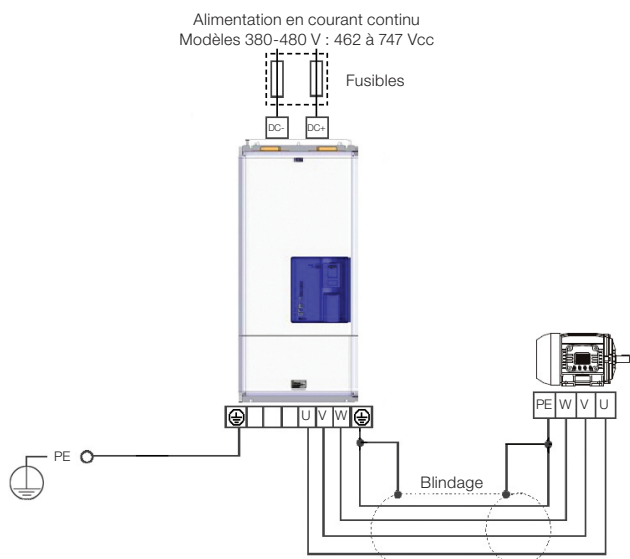

Figure 11 : Schéma de connexion de l'alimentation pour les tailles F et G avec un matériel CC spécial

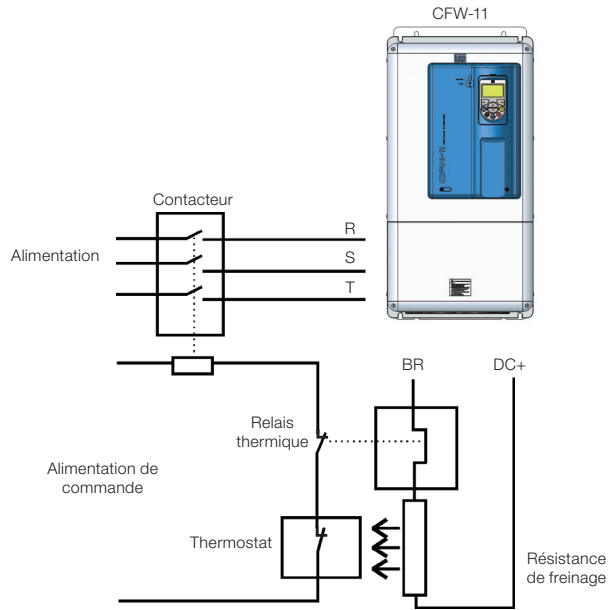

Figure 12 : Schéma de connexion de la résistance de freinage pour les tailles A, B, C, D et E

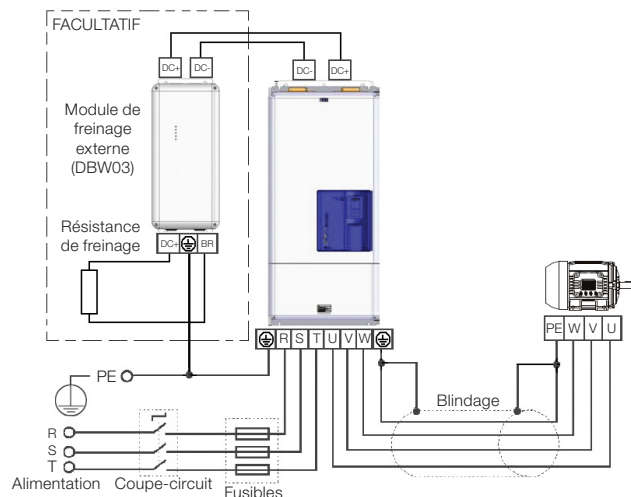

Figure 13 : Schéma de connexion de l'alimentation pour les tailles F et G avec résistance de freinage

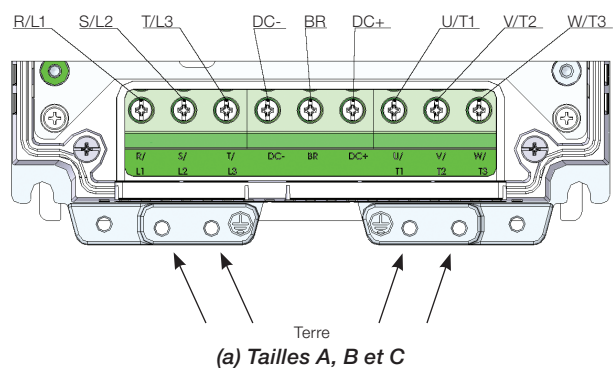
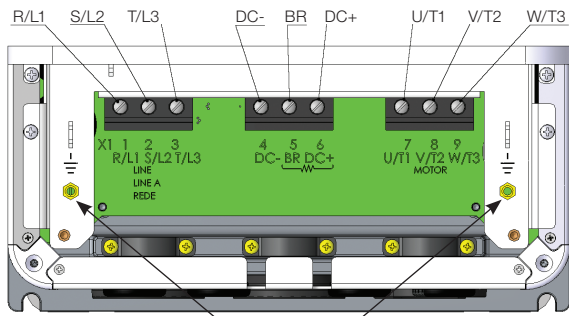
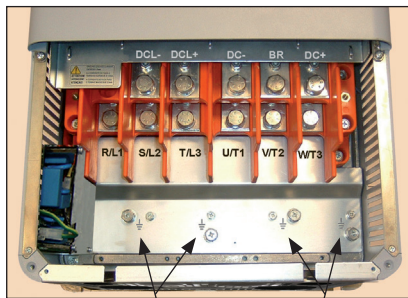

Figure 14 (a) : Bornes de terre et d'alimentation - Tailles A à C



(b) Taille D



(c) Taille E

Figure 14 (b) et (c) : Bornes de terre et d'alimentation - Tailles D et E

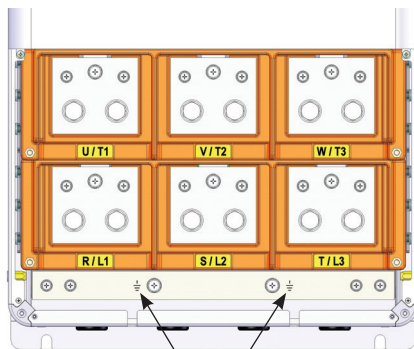

(a) Standard

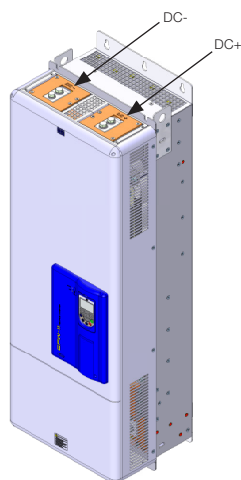

(b) Matériel CC spécial

Figures 15 (a) et (b) : Bornes de terre et d'alimentation - Tailles F et G

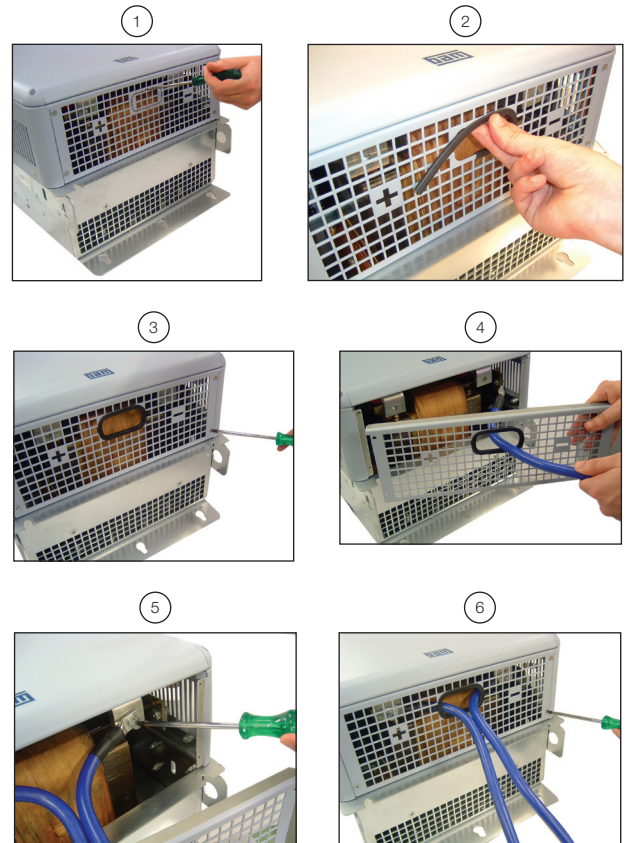

Figure 16 : Connexion du module de freinage dynamique - Tailles standard F et G

REMARQUES SUR LES CIRCUITS ET LES APPAREILS

- L'alimentation du variateur doit comporter un fil neutre raccordé à la terre. Pour les réseaux informatiques, certains composants internes doivent être déconnectés : voir figures 17 à 19.
- Montez un dispositif de coupure sur l'alimentation du variateur. Ce composant doit déconnecter l'alimentation du variateur si cela est nécessaire (ex. pendant l'entretien et la maintenance).
- Utilisez des fusibles rapides en entrée pour protéger le redresseur et le câblage du variateur. Voir les tableaux A.1 et A.2 pour les fusibles adaptés (I²t doit être inférieure ou égale à la valeur indiquée dans les tableaux tenant compte de la valeur d'extinction à froid (et non en fusion).
- Pour remplir les conditions des normes UL, utilisez des fusibles de classe J sur l'alimentation du variateur ayant un courant qui n'est pas supérieur aux valeurs des tableaux A.1 et A.2.
- Facultativement, vous pouvez utiliser des fusibles lents sur l'entrée. Ils doivent être spécifiés pour un courant égal à 1,2 fois le courant nominal d'entrée du variateur. Dans ce cas, l'installation est protégée contre les courts-circuits, mais pas le redresseur d'entrée du variateur. Cela peut entraîner des détériorations plus importantes du variateur en cas de panne d'un composant interne.
- Les variateurs CFW-11 sont adaptés à un circuit fournissant au maximum 100 000 Aeff symétriques (230 V / 480 V).
- Câble blindé du moteur recommandé et conforme à la norme IEC 60034-25.
- Laissez un espace minimal de 25 cm entre les câbles moteur et les autres câbles (signaux, capteurs, commande, etc.).

RÉSEAUX INFORMATIQUES

Lorsque la masse n'est pas raccordée à la terre ou si la terre présente une résistance importante ou est raccordée dans des réseaux en étoile.

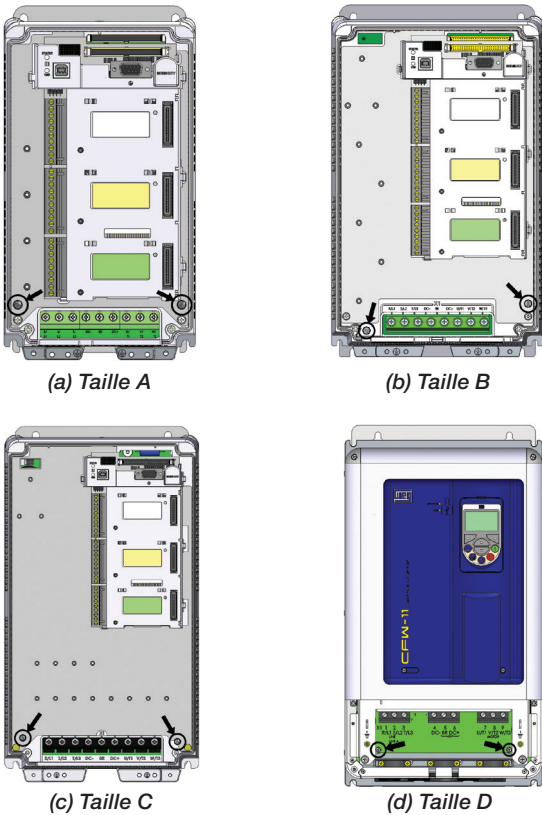

Figures 17 (a) à (d) : Tailles A à D - Emplacement des vis de terre - Enlever pour les réseaux informatiques

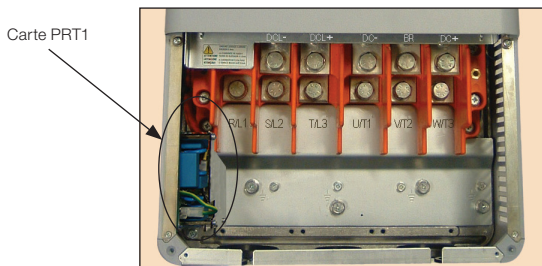

(a) Emplacement de la carte

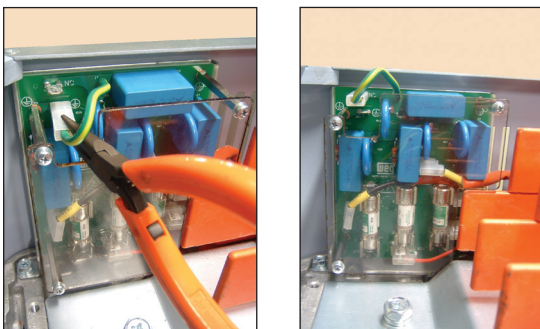

(b) Position initiale (c) Position finale (IT)

Figures 18 (a) à (c) : Taille E - Emplacement de la borne sur une carte PRT1 – Modifier la position pour les réseaux informatiques

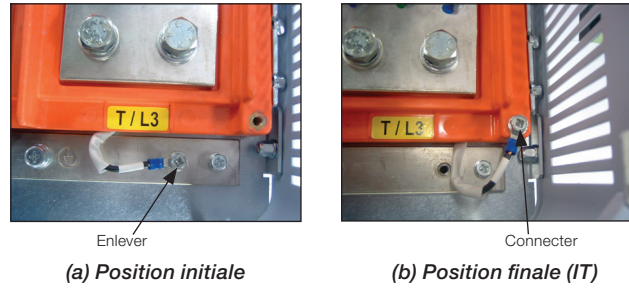

(a) Position initiale (b) Position finale (IT)

Figures 19 (a) et (b) : Tailles F et G - Emplacement de la borne sur une carte PRT1 – Modifier la position pour les réseaux informatiques

RACCORDEMENTS À LA TERRE



DANGER!

La masse du variateur doit être raccordée à une terre de protection (PE).

Voir les réglementations locales et/ou les normes électriques pour choisir la section des fils de terre. Connectez les bornes de masse du variateur à une barre de terre, à un point unique de raccordement à la terre ou à un point commun de raccordement à la terre (impédance $\leq 10 \Omega$).

Pour la conformité à la norme IEC 61800-5-1, raccordez le variateur à la terre au moyen d'un seul câble en cuivre de section minimale 10 mm², du fait que le courant de fuite est supérieur à 3,5 mA CA.



ATTENTION!

Le fil de masse de l'alimentation secteur doit être fermement raccordé à la terre. Cependant, ce fil e doit s'utiliser pour raccorder le variateur à la terre.



Figura 20 : Raccordements à la terre de plusieurs variateurs

CONNEXIONS DES CÂBLES DE COMMANDE

Les connexions des câbles de commande (entrées/sorties analogiques, entrées/sorties numériques) doivent s'effectuer sur le connecteur XC1 de la carte de commande CC11.

	XC1 Barrette de connexion		Fonction réglée en usine
Sens horaire	1	REF+	Référence positive du potentiomètre (5.4 V ± 5 %).
	2	AI1+	Entrée analogique n° 1 : Référence de vitesse (à distance).
Sens anti-horaire	3	AI1-	
	4	REF-	Référence négative du potentiomètre (-4,7 V ± 5 %).
≥ 5 kΩ	5	AI2+	Entrée analogique n° 2 : Aucune fonction.
	6	AI2-	
tr/min	7	AO1	Sortie analogique n° 1 : Vitesse .
courant	8	AGND (24 V)	Référence (0 V) des sorties analogiques.
	9	AO2	Sortie analogique n° 2 : Courant moteur.
	10	AGND (24 V)	Référence (0 V) des sorties analogiques.
	11	DGND*	Référence (0 V) pour l'alimentation 24 Vcc.
	12	COM	Point commun des entrées numériques.
	13	24 Vcc	Alimentation 24 Vcc.
	14	COM	Point commun des entrées numériques.
	15	DI1	Entrée numérique n° 1 : Marche / Arrêt (Start / Stop).
	16	DI2	Entrée numérique n° 2 : Sens de rotation (distant).
	17	DI3	Entrée numérique n° 3 : Aucune fonction.
	18	DI4	Entrée numérique n° 4 : Aucune fonction.
	19	DI5	Entrée numérique n° 5 : Jog (distant).
	20	DI6	Entrée numérique n° 6 : 2 ^{ème} rampe.
	21	NC1	Sortie numérique n° 1 DO1 (RL1) : Absence anomalie.
22	C1		
23	NO1		
	24	NC2	Sortie numérique n° 2 DO2 (RL2) : N > N _x - Vitesse > P0288.
	25	C2	
26	NO2		
	27	NC3	Sortie numérique n° 3 DO3 (RL3) : N* > N _x - Référence vitesse > P0288.
	28	C3	
29	NO3		

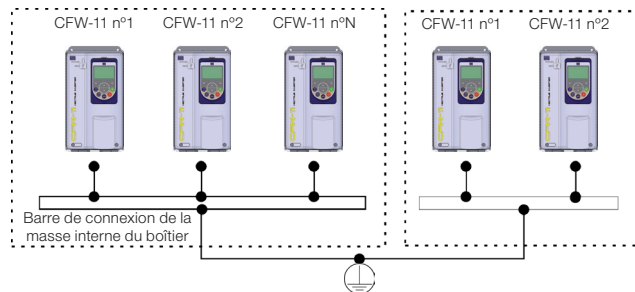
Figure 21: Signaux sur le connecteur XC1 - Entrées numériques fonctionnant en "Signal haut actif"



REMARQUE !

Pour passer en "Signal actif bas", enlevez le cavalier entre XC1:11 et 12 et placez-le entre XC1:12 et 13 ; raccordez les points communs des interrupteurs sur DI1 à DI6 à XC1:11 au lieu de XC1:13.

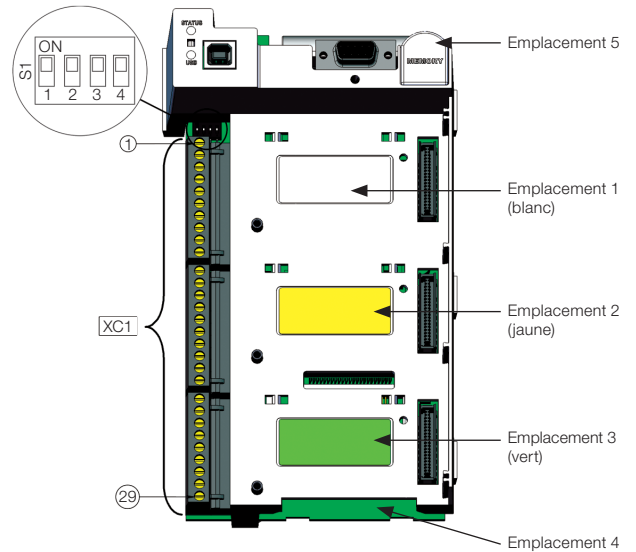

Signal	Fonction par défaut réglée en usine	Mini-interrupteur DIP	Sélection	Réglage en usine
AI1	Référence de vitesse (à distance)	S1.4	OFF : 0 à 10 V (réglage usine) ON : 4 à 20 mA / 0 à 20 mA	OFF
AI2	Aucune fonction	S1.3	OFF : 0 à ±10 V (réglage usine) ON : 4 à 20 mA / 0 à 20 mA	OFF
AO1	Vitesse	S1.1	OFF : 4 à 20 mA / 0 à 20 mA ON : 0 à 10 V (réglage usine)	ON
AO2	Courant moteur	S1.2	OFF : 4 à 20 mA / 0 à 20 mA ON : 0 à 10 V (réglage usine)	ON

Figure 22 : Mini-interrupteurs DIP de configuration du type de signal des entrées et sorties analogiques



REMARQUE!

Pour en savoir plus sur la fonction d'arrêt de sécurité (STO), voir le Manuel d'installation, de configuration et d'utilisation.

Connexions de commande typiques

Connexion de commande n° 1 - Fonction Marche / Arrêt commandée à partir du clavier (mode local).

Avec cette connexion, il est possible d'utiliser le variateur en mode local avec les réglages d'usine par défaut. Ce mode est recommandé pour les utilisateurs novices du fait qu'aucune connexion de commande supplémentaire n'est nécessaire.

Connexion de commande n° 2 - Fonction Marche / Arrêt sur 2 fils (mode distant).

Cet exemple de connexion s'applique uniquement aux réglages d'usine par défaut si le variateur est configuré en mode distant. Avec ces réglages, le choix du mode de fonctionnement (local/distant) s'effectue sur la touche **LOC** du pupitre opérateur (mode local par défaut). Configurez P0220=3 pour modifier le réglage par défaut de la touche **REM** et passer en mode distant.

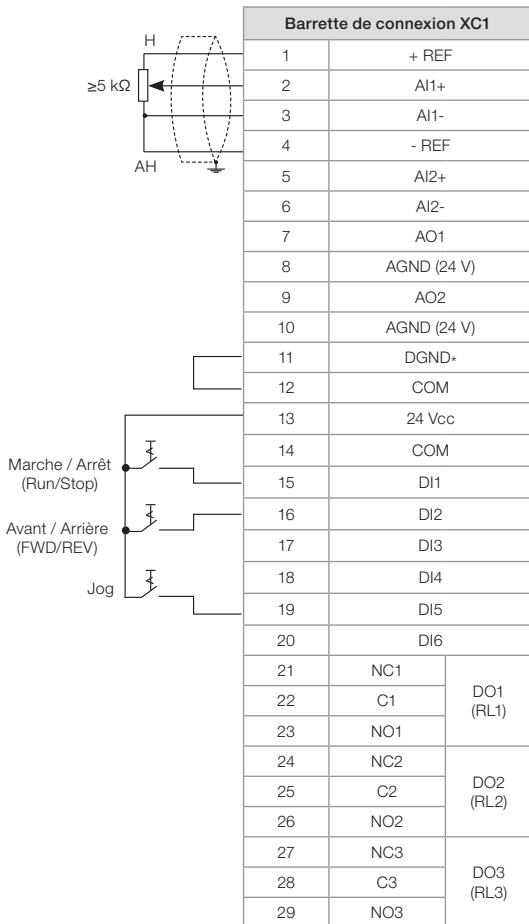

Figure 23 : Raccordement de la borne XC1 pour la connexion de commande n° 2

Connexion de commande n° 3 - Fonction Marche / Arrêt sur 3 fils.

Activation de la fonction Marche / Arrêt avec 3 fils de commande. Paramètres à régler :

Configurez DI3 sur START (Marche) : P0265=6

Configurez DI4 sur STOP (Arrêt) : P0266=7

Configurez P0224=1 (Dlx) pour la commande sur 3 fils en mode local.

Configurez P0227=1 (Dlx) pour la commande sur 3 fils en mode distant.

Configurez le choix Forward/Reverse (Avant/Arrière) avec l'entrée numérique n° 2 (DI2).

Configurez P0223=4 pour le mode local ou P0226=4 pour le mode distant.

S1 et S2 représentent respectivement les boutons poussoirs Start (contact NO) et Stop (contact NF).

La référence de vitesse peut être fournie sur l'entrée analogique (comme dans la connexion de commande n° 2), sur le clavier (comme dans la connexion de commande n° 1) ou par une autre source disponible.

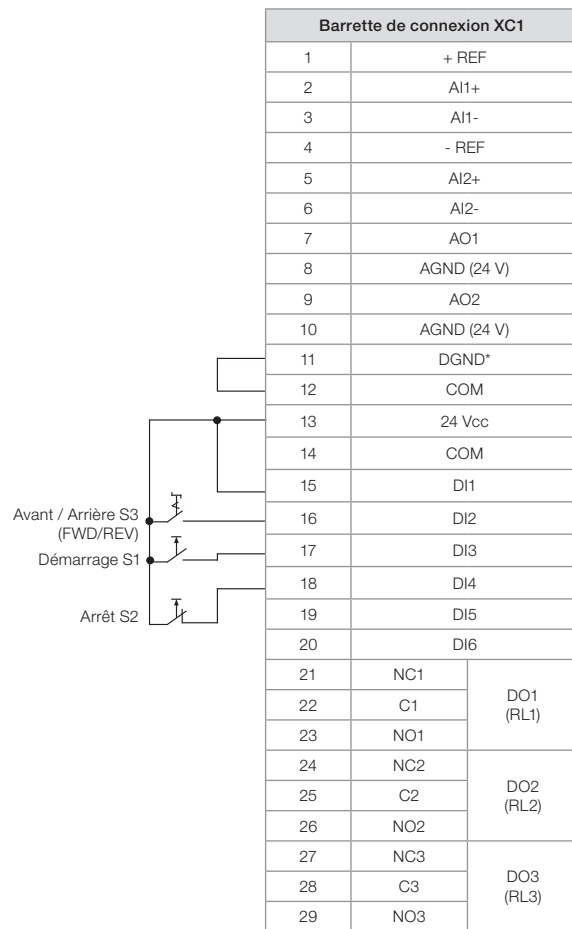

Figure 24 : Raccordement de la borne XC1 pour la connexion de commande n° 3



Connexion de commande n° 4 - Avant / Arrière (Forward/Reverse).

Activation de la fonction Forward/Reverse (Avant/Arrière).

Paramètres à régler :

Configurez DI3 sur marche avant (Forward) : P0265=4

Configurez DI4 sur marche arrière (Reverse) : P0266=5

Lorsque la fonction Forward/Reverse est configurée, elle est active en mode local ou distant. Simultanément, les touches  et  du pupitre opérateur restent inactives (même si P0224=0 ou P0227=0). Le sens de rotation est déterminé par les entrées Forward (Avant) et Reverse (Arrière).

Sens horaire pour la marche avant et anti-horaire pour la marche arrière.

La référence de vitesse peut être fournie par n'importe quelle source (comme dans la connexion de commande n° 3).

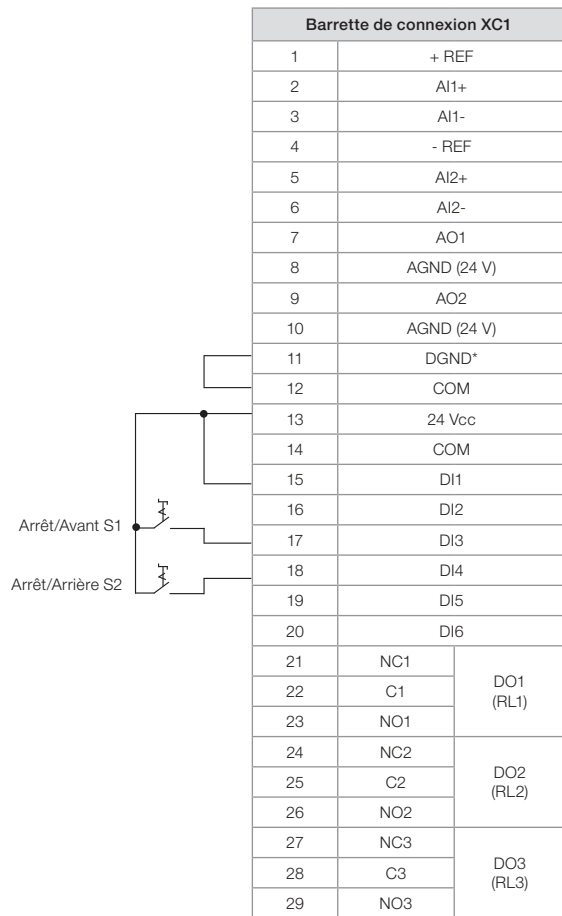

Figure 25 : Raccordement de la borne XC1 pour la connexion de commande n° 4

INSTALLATION CONFORME À LA DIRECTIVE EUROPÉENNE DE COMPATIBILITÉ ÉLECTROMAGNÉTIQUE

Les variateurs de tailles A à D avec l'option FA (CFW11XXXXXXOFA) et tous les variateurs standard des autres tailles sont équipés d'un filtre antiparasite interne pour diminuer les interférences électromagnétiques. Correctement installés, ces variateurs sont conformes à la Directive de compatibilité électromagnétique "2004/108/EC".

ATTENTION !

Pour utiliser des modèles équipés de filtres antiparasites dans des réseaux informatiques, exécutez les instructions des figures 17 à 19.

Installation conforme

Pour l'installation conforme, utilisez :

1. Des variateurs de taille A à D : avec les filtres antiparasites internes CFW11XXXXXXOFA et tous les autres modèles standard.
2. Des câbles de sortie blindés (câbles moteur) et raccordez le blindage aux 2 extrémités (moteur et variateur) avec une connexion de faible impédance pour les hautes fréquences. Des câbles moteur de longueur minimale et des niveaux d'émission et de rayonnement des interférences conformes aux tableaux 2 et 3. Si un niveau d'émissions plus faibles et/ou un câble moteur plus long sont nécessaires, il est alors indispensable de monter un filtre antiparasite externe à l'entrée du variateur. Pour plus d'informations, (références commerciales des filtres antiparasites, longueur des câbles moteur et niveaux d'émission), voir les tableaux 2 et 3.
3. Des câbles de commande blindés.
4. Un raccordement correct à la terre du variateur.

Tableau 2 : Niveaux d'émissions par conduction et rayonnement pour les tailles A à D

Modèle de variateur (avec filtre antiparasite intégré)	Sans filtre antiparasite externe			Avec filtre antiparasite externe					
	Émissions par conduction - Longueur maximale du câble moteur		Émissions par rayonnement	Référence du filtre antiparasite externe (fabricant : EPCOS)		Émissions par conduction - Longueur maximale du câble moteur		Émissions par rayonnement - Catégorie	
	Catégorie C3	Catégorie C2				Catégorie C2	Catégorie C2	Catégorie C1	Sans boîtier métallique
			Catégorie C2		Catégorie C2				
CFW11 0006 S 2 O FA	100 m	7 m	C2	B84142-A16-R122	75 m	50 m	C2	C2	
CFW11 0007 T 2 O FA	100 m	5 m	C2	B84143-G8-R110	100 m	-	C2	C2	
				B84143-A8-R105	50 m	50 m			
CFW11 0007 S 2 O FA	100 m	7 m	C2	B84142-A16-R122	75 m	50 m	C2	C2	
				B84142-B16-R	100 m	100 m			
CFW11 0010 S 2 O FA	100 m	7 m	C2	B84142-A30-R122	75 m	50 m	C2	C2	
				B84142-B25-R	100 m	100 m			
CFW11 0010 T 2 O FA	100 m	5 m	C2	B84143-G20-R110	100 m	-	C2	C2	
				B84143-A16-R105	50 m	50 m			
CFW11 0013 T 2 O FA	100 m	5 m	C2	B84143-G20-R110	100 m	-	C2	C2	
				B84143-A16-R105	50 m	50 m			
CFW11 0016 T 2 O FA	100 m	5 m	C2	B84143-G20-R110	100 m	-	C2	C2	
				B84143-A25-R105	50 m	50 m			
CFW11 0024 T 2 O FA	100 m	Non	C2	B84143-A36-R105	100 m	100 m	C2	C2	
CFW11 0028 T 2 O FA	100 m	Non	C2	B84143-A36-R105	100 m	100 m	C2	C2	
CFW11 0033 T 2 O FA	100 m	Non	C2	B84143-A50-R105	100 m	100 m	C2	C2	
CFW11 0045 T 2 O FA	100 m	Non	C3	B84143-A50-R105	100 m	100 m	C3	C2	
CFW11 0054 T 2 O FA	100 m	Non	C3	B84143-A66-R105	100 m	100 m	C3	C2	
CFW11 0070 T 2 O FA	100 m	Non	C3	B84143-A90-R105	100 m	100 m	C3	C2	
CFW11 0086 T 2 O FA	100 m	Non	C3	B84143-A120-R105	100 m	100 m	C3	C2	
CFW11 0105 T 2 O FA	100 m	Non	C3	B84143-A120-R105	100 m	100 m	C3	C2	
				B84143-G8-R110	100 m	-			
CFW11 0003 T 4 O FA	100 m	5 m	C2	B84143-A8-R105	50 m	50 m	C2	C2	
				B84143-G8-R110	100 m	-			
CFW11 0005 T 4 O FA	100 m	5 m	C2	B84143-G8-R110	100 m	-	C2	C2	
				B84143-A8-R105	50 m	50 m			
CFW11 0007 T 4 O FA	100 m	5 m	C2	B84143-G8-R110	100 m	-	C2	C2	
				B84143-A8-R105	50 m	50 m			
CFW11 0010 T 4 O FA	100 m	5 m	C2	B84143-G20-R110	100 m	-	C2	C2	
				B84143-A16-R105	50 m	50 m			
CFW11 0013 T 4 O FA	100 m	5 m	C2	B84143-G20-R110	100 m	-	C2	C2	
				B84143-A16-R105	50 m	50 m			
CFW11 0017 T 4 O FA	100 m	Non	C2	B84143-A25-R105	100 m	100 m	C2	C2	
CFW11 0024 T 4 O FA	100 m	Non	C2	B84143-A36-R105	100 m	100 m	C2	C2	
CFW11 0031 T 4 O FA	100 m	Non	C2	B84143-A36-R105	100 m	100 m	C2	C2	
CFW11 0038 T 4 O FA	100 m	Non	C3	B84143-A50-R105	100 m	100 m	C3	C2	
CFW11 0045 T 4 O FA	100 m	Non	C3	B84143-A50-R105	100 m	100 m	C3	C2	
CFW11 0058 T 4 O FA	100 m	Non	C3	B84143-A66-R105	100 m	100 m	C3	C2	
CFW11 0070 T 4 O FA	100 m	Non	C3	B84143-A90-R105	100 m	100 m	C3	C2	
CFW11 0088 T 4 O FA	100 m	Non	C3	B84143-A120-R105	100 m	100 m	C3	C2	

Tableau 3 : Niveaux d'émissions par conduction et rayonnement pour les tailles E à G

Modèle de variateur (filtre antiparasite intégré)	Châssis	Sans filtre antiparasite externe		Avec filtre antiparasite externe			
		Émissions par conduction - Longueur maximale du câble moteur		Référence du filtre antiparasite externe (fabricant : EPCOS)	Émissions par conduction - Longueur maximale du câble moteur		Émissions par rayonnement - Sans boîtier métallique
		Catégorie C3	Catégorie		Catégorie C2	Catégorie C2	
				Catégorie			Catégorie
CFW11 0142 T2		100 m	C2	B84143-B0150-S020	100 m	C2	
CFW11 0180 T2		100 m	C2	B84143-B0180-S020 (1)	100 m	C2	
CFW11 0211 T2		100 m	C2	B84143-B0250-S020 (2)	100 m	C2	
CFW11 0105 T4	E	100 m	C2	B84143-B0150-S020	100 m	C2	
CFW11 0142 T4		100 m	C2	B84143-B0150-S020	100 m	C2	
CFW11 0180 T4		100 m	C2	B84143-B0180-S020 (1)	100 m	C2	
CFW11 0211 T4		100 m	C2	B84143-B0250-S020 (2)	100 m	C2	
CFW11 0242 T4		100 m	C3 (3)	B84143-B0250-S021	100 m (4)	C3	
CFW11 0312 T4		100 m	C3 (3)	B84143-B01420-S021	100 m (4)	C3	
CFW11 0370 T4	F	100 m	C3 (3)	B84143-B0400-S021	100 m (4)	C3	
CFW11 0477 T4		100 m	C3 (3)	B84143-B0600-S021	100 m (4)	C3	
CFW11 0515 T4		100 m	C3 (3)	B84143-B0600-S021	100 m (4)	C3	
CFW11 0601 T4	G	100 m	C3 (3)	B84143-B0600-S021	100 m (4)	C3	
CFW11 0720 T4		100 m	C3 (3)	B84143-B1000-S021	100 m (4)	C3	

Remarques sur le tableau 3 :

- (1) Pour une température de l'air autour du variateur/filtre supérieure à 40 °C (104 °F) et un courant de sortie permanent supérieur à 172 Aeff, le filtre B84143B0250S020 est indispensable.
- (2) Pour une température de l'air autour du variateur/filtre de 40 °C (104 °F) et des applications intensives (conditions difficiles, courant de sortie < 180 Aeff), il est possible d'utiliser le filtre B84143B0180S020.
- (3) Avec âme toroidale dans les 3 câbles secteur. Exemple : TDK PN : PC40 UU120x160x20.
- (4) Fréquence minimale de fonctionnement 2,5 Hz.

CLAVIER INTÉGRÉ - HMI-CFW11

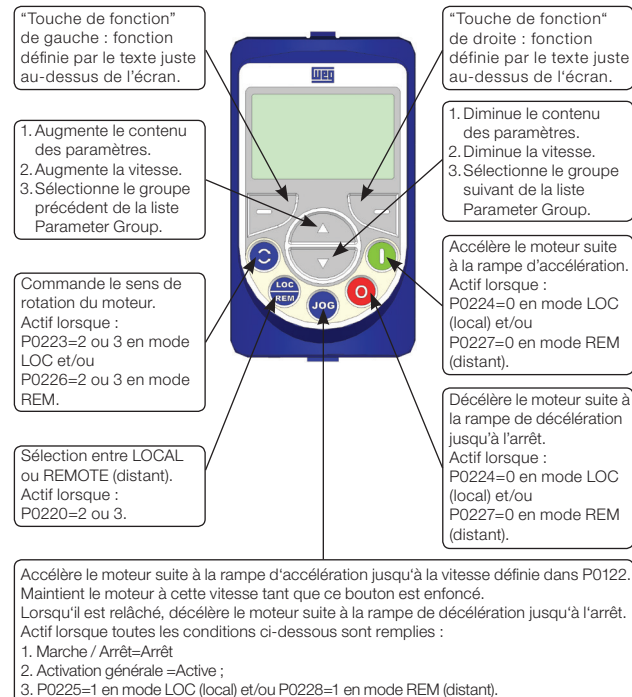

Figure 26 : Touches et fonctions du clavier

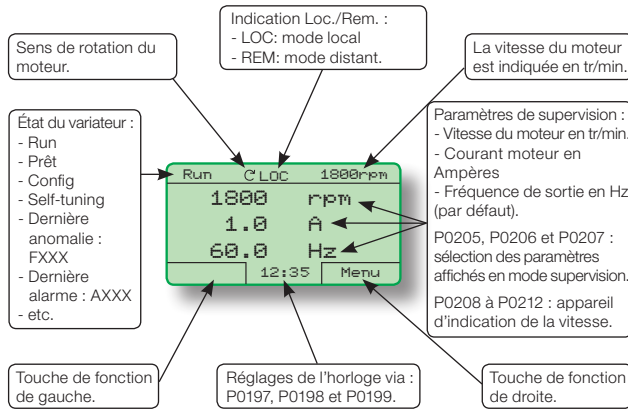

Figure 27 : Exemple - Clavier sur écran et fonctions réglées par défaut en usine (mode supervision)



Figure 28 : Cache-batterie du clavier

Remarques sur le clavier :

- Connexion possible „à chaud“.
- Il est possible de programmer d'autres types d'écrans de supervision (graphiques à barres, grandes polices) en définissant les paramètres P0205-207, P0208-212.
- La batterie sert uniquement au fonctionnement de l'horloge interne lorsque le variateur n'est pas alimenté. Si elle est complètement déchargée ou si elle n'est pas installée, l'heure affichée sera faussée et l'alarme "A181 - Invalid clock time" s'affiche à chaque mise sous tension du variateur.
- A la fin de la durée d'utilisation de la batterie, ne la jetez pas dans votre conteneur à déchets, mais utilisez un site d'élimination adapté.

STRUCTURE DES PARAMÈTRES

Lorsque vous appuyez sur la touche de fonction de droite ("MENU") en mode supervision, l'écran affiche les premiers groupes de paramètres. Le nom et le nombre des groupes peuvent varier en fonction de la version du micrologiciel utilisée.

DÉMARRAGE

DANGER !
Le variateur sera détérioré si l'alimentation est connectée aux bornes de sortie.

AVANT DE METTRE SOUS TENSION

- 1) Vérifiez que les connexions de l'alimentation, de la terre et des commandes sont correctes et solidement fixées.
- 2) Enlevez à l'intérieur du variateur ou du boîtier tous les corps étrangers laissés après l'installation.
- 3) Vérifiez les connexions du moteur et que sa tension et son courant sont compris dans les valeurs nominales du variateur.
- 4) Désaccouplez mécaniquement le moteur de la charge. S'il n'est pas possible de désaccoupler le moteur, vérifiez que le sens de rotation (avant ou arrière) ne provoquera pas de blessure et/ou ne détériorera pas le matériel.
- 5) Fermez les capots du variateur ou du boîtier.
- 6) Mesurez la tension d'alimentation et vérifiez qu'elle est conforme à la plage autorisée.
- 7) Appliquez l'alimentation en fermant le coupe-circuit à l'entrée.
- 8) Vérifiez le résultat à la première mise sous tension :
Le clavier doit afficher le mode de supervision standard ; la DEL d'état doit être verte en permanence.

DÉMARRAGE EN MODE V/F

La procédure de démarrage en mode V/f s'effectue en trois opérations en utilisant la routine **Oriented Start-up** (Démarrage orienté) et le groupe **Basic Application** (Application de base).

1) P0000 : définition du mot de passe

Opération	Action/Résultat	Affichage
1	- Mode supervision. - Appuyez sur "Menu" (touche de fonction de droite).	
2	- Le groupe "00 TOUS PARAMETRES" (Tous les paramètres) est déjà sélectionné. - Appuyez sur "Selec.".	
3	- Le paramètre "Acces aux paramètres P0000: 0" est déjà sélectionné. - Appuyez sur "Selec.".	
4	- Per impostare la password, premere fino a visualizzare il numero 5 sul display.	
5	- Lorsque le chiffre 5 s'affiche, appuyez sur "Enreg.".	
6	- Si le paramètre est correctement défini, l'écran doit afficher "Acces aux paramètres P0000: 5". - Appuyez sur "Retour" (touche de fonction de gauche).	
7	- Appuyez sur "Retour".	
8	- L'écran revient en mode supervision.	

Figure 29: Opérations permettant de modifier les paramètres via P0000

2) Démarrage orienté

Le groupe de paramètres «Oriented Start-up» (Démarrage orienté) facilite le paramétrage du variateur. Le paramètre P0317 de ce groupe permet d'entrer dans la routine de démarrage orienté (Oriented Start-up).

Cette routine présente sur le pupitre opérateur la suite logique des principaux paramètres. Les paramètres minimaux nécessaires au fonctionnement correct sont réglés. Les informations telles que la tension secteur et les données de la plaque signalétique sont saisies.

Pour entrer dans la routine «Oriented Start-up», modifiez le paramètre P0317 avec la valeur 1, puis définissez tous les paramètres restants au fur et à mesure qu'ils s'affichent.

La définition des paramètres de la routine «Oriented Start-up» entraîne la modification automatique du contenu des autres paramètres et/ou des variables internes du variateur.

Pendant l'exécution de la routine, le message «Config» s'affiche dans le coin supérieur gauche de l'écran du pupitre opérateur.

3) Paramètres d'une application de base

Après avoir exécuté la routine «Oriented Start-up» et correctement défini les paramètres, le variateur est prêt à fonctionner en mode V/f mode.

Le groupe Basic Application (Application de base) comporte les paramètres applicatifs les plus courants.

RÉGLAGE DE LA DATE ET DE L'HEURE

Accédez l'interface des groupes et modifiez : le jour (P0194), le mois (P0195) et l'année (P0196) ; le temps : l'heure (P0197), les minutes (P0198) et les secondes (P0199).

BLOPAGE DE LA MODIFICATION DES PARAMÈTRES

Pour éviter les modifications non autorisées ou accidentelles des paramètres, vous pouvez définir le paramètre P0000 avec une valeur différente de 5.

FONCTIONS DU MODULE MÉMOIRE FLASH

- Enregistrez une copie des paramètres du variateur.
- Transférez les paramètres enregistrés en mémoire FLASH dans le variateur.
- Transférez le micrologiciel enregistré en mémoire FLASH dans le variateur.
- Enregistrez le programme créé avec SoftPLC.

A la mise sous tension du variateur, ce programme (SoftPLC) est transféré dans la mémoire RAM de la carte de commande du variateur ; il est alors exécuté.

Voir le manuel de programmation CFW-11 et le manuel (SoftPLC) pour plus d'informations.

Tableau A.2 : Caractéristiques techniques des tailles E à G

Modèle	Châssis	Nombre de phases	Utiliser en cycle de service normal (ND)						Utiliser en cycle de service intensif (HD)						Freinage dynamique	Température de l'air ambiant [°C (°F)]	Fusible I ² t [A ² s] @ 25 °C	Fusible [A] conforme à la norme européenne IEC	Disponibilité des kits d'options qu'il est possible d'incorporer au produit
			Courant nominal de sortie ⁽¹⁾ [Aeff]	Courant de surcharge ⁽²⁾ [Aeff]	Fréquence nominale de la porteuse [kHz]	Puissance maximale moteur [cv/kW]	Courant nominal d'entrée [Aeff]	Puissance dissipée [W]	Courant nominal de sortie ⁽¹⁾ [Aeff]	Courant de surcharge ⁽²⁾ [Aeff]	Fréquence nominale de la porteuse [kHz]	Puissance maximale moteur [cv/kW]	Courant nominal d'entrée [Aeff]	Puissance dissipée [W]					
CFW11 0142 T 2	E	3ø	142	156.2	213	2.5	50/37	142	1490	210	1280	200	64.0 (141.1)	200	39200	200	39200	Nema 1 (kit KNIE-01) Nema 1 (kit KNIE-02) Nema 1 (kit KNIE-01) Nema 1 (kit KNIE-02)	
CFW11 0180 T 2		3ø	180	198	270	2.5	60/45	180	1820	360	1550	350	65.0 (143.3)	200	218000	200	218000		
CFW11 0211 T 2		3ø	211	232	317	2.5	75/65	211	2040	360	1690	350	65.0 (143.3)	250	218000	250	218000		
CFW11 0105 T 4		3ø	105	115.5	157.5	2.5	75/65	105	1270	200	1020	190	62.5 (137.8)	125	39200	125	39200		
CFW11 0142 T 4	E	3ø	142	156.2	213	2.5	100/75	142	1680	210	1290	200	64.0 (141.1)	200	39200	200	39200	Nema 1 (kit KNIE-01) Nema 1 (kit KNIE-02)	
CFW11 0180 T 4		3ø	180	198	270	2.5	150/110	180	2050	360	1570	350	65.0 (143.3)	200	218000	200	218000		
CFW11 0211 T 4		3ø	211	232.1	317	2.5	175/132	211	2330	360	1940	350	65.0 (143.3)	250	218000	250	218000		
CFW11 0242 T 4		3ø	242	266	363	2.5	200/150	242	1518	285	1277	227	130 (286.6)	315	320000	315	320000		
CFW11 0312 T 4	F	3ø	312	343	468	2.5	250/185	312	2034	375	1507	292	132 (291.0)	500	414000	500	414000	IP20 IP20 IP20 IP20 IP20 IP20	
CFW11 0370 T 4		3ø	370	407	555	2.5	300/220	370	2497	407	2008	320	135 (297.6)	500	414000	500	414000		
CFW11 0477 T 4		3ø	477	525	716	2.5	400/300	477	3273	595	2451	465	140 (308.6)	700	1051000	700	1051000		
CFW11 0515 T 4		3ø	515	567	773	2	400/300	515	3338	769	2987	644	204 (449.7)	900	1445000	900	1445000		
CFW11 0601 T 4	G	3ø	601	662	900	2	500/370	601	3875	781	3219	639	207 (456.4)	900	1445000	900	1445000	IP20 IP20	
CFW11 0720 T 4		3ø	720	792	1080	2	600/440	720	4576	858	3747	653	215 (474.0)	1100	1445000	1100	1445000		

Modèles avec alimentation 380... 440 V

Remarques :

- (1) Courant nominal stable dans les conditions suivantes :
 - Fréquences de commutation spécifiées.
 - Température de l'air environnant spécifiée dans les tableaux. Pour des températures élevées, limitées à 10 °C au-dessus de la température maximale spécifiée pour les conditions nominales, le courant de sortie doit être déclassé de 2 % par °C au-dessus de la température maximale spécifiée.
 - Humidité relative de l'air : 5 % à 90 % sans condensation.
 - Altitude : 1 000 m. De 1 000 m à 4 000 m, le courant de sortie doit être déclassé de 1 % par 100 m au-dessus de 1 000 m.
 - Milieu ambiant avec degré de pollution 2 (conforme aux normes EN50178 et UL508C).
- (2) Les puissances moteur ne représentent que des valeurs indicatives pour les moteurs WEG 230 V ou 460 V, 4 pôles. Le dimensionnement du variateur correct doit être basé sur le courant nominal du moteur utilisé.

Tableau A.3 : Caractéristiques de freinage dynamique des tailles A à E

Modèle du variateur	Courant maximal de freinage (I _{max}) [A]	Puissance maximale de freinage (valeur crête) (P _{max}) [kW] ⁽²⁾	Courant efficace de freinage (I _{efficace}) ⁽¹⁾ [A]	Puissance dissipée (moyenne) dans la résistance de freinage (P _R) [kW] ⁽²⁾	Résistance recommandée [Ω]	Section des fils d'alimentation (bornes DC+ et BR) [mm ² (AWG)]
CFW11 0006 B 2	5.3	2.1	5.2	2.03	75	1.5 (16)
CFW11 0006 S 2 O FA	5.3	2.1	5.2	2.03	75	1.5 (16)
CFW11 0007 B 2	7.1	2.9	6.96	2.71	56	1.5 (16)
CFW11 0007 S 2 O FA	7.1	2.9	6.96	2.71	56	1.5 (16)
CFW11 0007 T 2	5.3	2.1	5.2	2.03	75	1.5 (16)
CFW11 0010 S 2	11.1	4.4	10.83	4.22	36	2.5 (14)
CFW11 0010 T 2	7.1	2.9	6.96	2.71	56	1.5 (16)
CFW11 0013 T 2	11.1	4.4	8.54	2.62	36	2.5 (14)
CFW11 0016 T 2	14.8	5.9	14.44	5.63	27	4 (12)
CFW11 0024 T 2	26.7	10.7	19.15	5.5	15	6 (10)
CFW11 0028 T 2	26.7	10.7	18.21	4.97	15	6 (10)
CFW11 0033 T 2	26.7	10.7	16.71	4.19	15	6 (10)
CFW11 0045 T 2	44	17.6	33.29	10.1	9.1	10 (8)
CFW11 0054 T 2	48.8	19.5	32.17	8.49	8.2	10 (8)
CFW11 0070 T 2	48.8	19.5	26.13	5.6	8.2	6 (8)
CFW11 0086 T 2	93	37.2	90.67	35.3	4.3	35 (2)
CFW11 0105 T 2	111.1	44.4	90.87	29.7	3.6	35 (2)
CFW11 0003 T 4	3.6	2.9	3.54	2.76	220	1.5 (16)
CFW11 0005 T 4	5.3	4.3	5.2	4.05	150	1.5 (16)
CFW11 0007 T 4	5.3	4.3	5.2	4.05	150	1.5 (16)
CFW11 0010 T 4	8.8	7	8.57	6.68	91	2.5 (14)
CFW11 0013 T 4	10.7	8.5	10.4	8.11	75	2.5 (14)
CFW11 0017 T 4	12.9	10.3	12.58	9.81	62	2.5 (12)
CFW11 0024 T 4	17	13.6	16.59	12.9	47	4 (10)
CFW11 0031 T 4	26.7	21.3	20.49	12.6	30	6 (10)
CFW11 0038 T 4	36.4	29.1	26.06	14.9	22	6 (8)
CFW11 0045 T 4	47.1	37.6	40	27.2	17	10 (8)
CFW11 0058 T 4	53.3	42.7	31.71	15.1	15	10 (8)
CFW11 0070 T 4	66.7	53.3	42.87	22.1	12	10 (6)
CFW11 0088 T 4	87.9	70.3	63.08	36.2	9.1	25 (4)
CFW11 0142 T 2 O DB	266.7	106.7	142	30.2	1.5	70 (2/0) ou 2x 25 (2x 4)
CFW11 0180 T 2 O DB	266.7	106.7	180	48.6	1.5	120 (4/0) ou 2x 35 (2x 2)
CFW11 0211 T 2 O DB	333.3	133.3	211	53.4	1.2	150 (300) ou 2x 50 (2x 1)
CFW11 0105 T 4 O DB	186	148.8	105	47.4	4.3	50 (1)
CFW11 0142 T 4 O DB	266.7	213.3	142	60.5	3	70 (2/0) ou 2x 25 (2x 4)
CFW11 0180 T 4 O DB	266.7	213.3	180	97.2	3	120 (4/0) ou 2x 35 (2x 2)
CFW11 0211 T 4 O DB	363.6	290.9	191.7	80.8	2.2	120 (250) ou 2x 50 (2x 1)

Remarques :

(1) Le courant efficace de freinage est fourni uniquement à titre indicatif car il dépend du cycle de freinage. Ce courant se calcule d'après l'équation ci-dessous où t_{br} est exprimé en minutes et correspond à la somme de toutes les durées de freinage pendant le cycle de freinage le plus long 5 minutes.

$$I_{\text{efficace}} = I_{\text{max}} \cdot \sqrt{\frac{t_{\text{br}}}{5}}$$

(2) Les valeurs P_{max} et P_R (respectivement puissance maximale et moyenne de la résistance de freinage) indiquées sont correctes pour les résistances recommandées et pour les courants efficaces de freinage indiqués dans le tableau. La puissance de la résistance doit être modifiée en fonction du cycle de freinage.



Преобразователь частоты

Руководство по установке

Серия: CFW-11

Язык: русский

Документ: 10001803811 / 00

Дата публикации: 01/2013

РУССКИЙ

NEDERLANDS

ITALIANO

КРАТКАЯ ИНФОРМАЦИЯ

ОБ ЭТОМ РУКОВОДСТВЕ	107
ПРАВИЛА ТЕХНИКИ БЕЗОПАСНОСТИ.....	107
ОПИСАНИЕ ПРЕОБРАЗОВАТЕЛЯ ЧАСТОТЫ CFW-11	107
ПРИЕМКА И ХРАНЕНИЕ	107
УСТАНОВКА	107
ОБЩИЕ РЕКОМЕНДАЦИИ ПО МОНТАЖУ	107
МОНТАЖ В ШКАФ	108
ПОДКЛЮЧЕНИЕ ЭЛЕКТРООБОРУДОВАНИЯ.....	110
СХЕМЫ ПОДКЛЮЧЕНИЙ	110
РЕКОМЕНДАЦИИ ПО ЭЛЕКТРИЧЕСКИМ ЦЕПЯМ И УСТРОЙСТВАМ	111
СЕТИ С ИЗОЛИРОВАННОЙ НЕЙТРАЛЬЮ.....	112
ПОДКЛЮЧЕНИЕ ЗАЗЕМЛЕНИЯ.....	112
ПОДКЛЮЧЕНИЕ ЦЕПЕЙ УПРАВЛЕНИЯ	113
УСТАНОВКА В СООТВЕТСТВИИ С ТРЕБОВАНИЯМИ ДИРЕКТИВЫ ЕС ПО ЭЛЕКТРОМАГНИТНОЙ СОВМЕСТИМОСТИ.....	115
ВСТРОЕННАЯ КЛАВИАТУРА HMI-CFW11	116
СТРУКТУРА ПАРАМЕТРОВ.....	117
ЗАПУСК	117
ДЕЙСТВИЯ ПЕРЕД ПОДАЧЕЙ ЭЛЕКТРОПИТАНИЯ.....	117
ЗАПУСК В РЕЖИМЕ V/F	117
УСТАНОВКА ДАТЫ И ВРЕМЕНИ.....	118
ЗАПРЕТ ИЗМЕНЕНИЯ ПАРАМЕТРОВ	118
ФУНКЦИИ МОДУЛЯ ФЛЭШ-ПАМЯТИ	118
ПРИЛОЖЕНИЕ 1. ТЕХНИЧЕСКИЕ СПЕЦИФИКАЦИИ	119

ОБ ЭТОМ РУКОВОДСТВЕ

Настоящее руководство содержит сведения об установке и запуске в режиме V/f моделей преобразователя частоты CFW-11 с типоразмерами от А до G.

Подробные сведения см. в Руководстве пользователя CFW-11 и в Руководстве по программированию.

Преобразователь частоты CFW-11 можно использовать в следующих режимах управления: VVW, бездатчиковое векторное управление и векторное управление с шифратором для асинхронных электродвигателей, а также бездатчиковое векторное управление с шифратором для электродвигателей с постоянными магнитами. Дополнительные сведения см. в Руководстве по программированию.

Сведения о других функциях, принадлежностях и коммуникационных интерфейсах см. на веб-сайте компании WEG по адресу www.weg.net, где можно загрузить соответствующие руководства.

ПРАВИЛА ТЕХНИКИ БЕЗОПАСНОСТИ

Внимательно прочитайте настоящее руководство перед установкой или началом эксплуатации преобразователя.

Выполнять установку, запуск и обслуживание данного типа оборудования должен только обученный и квалифицированный персонал. Персонал должен следовать всем правилам техники безопасности, приведенным в данном руководстве и местных нормативных документах.



ВНИМАНИЕ!

Несоблюдение правил техники безопасности может привести к несчастным случаям, смерти и повреждению оборудования.

Всегда отключайте питание перед контактом с каким-либо электрическим устройством внутри преобразователя.

Многие компоненты могут находиться под высоким напряжением или в движении (например, вентиляторы) даже после отключения питания. Подождите не менее 10 минут до полной разрядки конденсаторов.

Всегда соединяйте корпус оборудования с защитным заземлением (PE).



ПРИМЕЧАНИЕ!

Под квалифицированным персоналом в настоящем руководстве понимается персонал, обученный выполнению перечисленных ниже задач.

1. Устанавливать, заземлять, включать и эксплуатировать CFW-11 в соответствии с настоящим руководством и действующими требованиями техники безопасности.
2. Пользоваться средствами защиты в соответствии с общепринятыми нормативными документами.
3. Оказывать первую помощь.



ПРИМЕЧАНИЕ!

Преобразователь частоты может создавать помехи и влиять на окружающее электрооборудование. Для уменьшения таких эффектов в точности следуйте рекомендациям по установке.

ОПИСАНИЕ ПРЕОБРАЗОВАТЕЛЯ ЧАСТОТЫ CFW-11

Преобразователь частоты CFW-11 представляет собой высокопроизводительное устройство, предназначенное для управления скоростью и крутящим моментом трехфазных асинхронных электродвигателей и электродвигателей с постоянными магнитами. Диапазон доступных моделей включает семь различных типоразмеров мощностью от 1 до 600 л. с. (от 0,75 до 450 кВт) при линейном напряжении от 200 до 480 В. Основной отличительной особенностью данного устройства является использование технологии Vectrue, которая позволяет реализовать следующие режимы управления: скалярное управление (V/f), VVW, бездатчиковое векторное управление и векторное управление с шифратором. Доступны следующие дополнительные функции: оптимальное торможение, самонастройка и оптимальный поток.

Более подробные сведения см. в Руководстве пользователя CFW-11 и в Руководстве по программированию.

ПРИЕМКА И ХРАНЕНИЕ

При приемке устройства убедитесь в выполнении указанных ниже условий.

Данные на паспортной табличке CFW-11 соответствуют данным заказа на покупку. См. перечень доступных моделей и их технические характеристики в [таблицах А.1 и А.2](#).

Устройство не было повреждено при транспортировке. В случае обнаружения каких-либо проблем немедленно свяжитесь с перевозчиком.

Если преобразователь частоты CFW-11 не планируется устанавливать сразу, его следует хранить в оригинальной упаковке в сухом и чистом помещении (при температуре от -25 °C до 60 °C).

УСТАНОВКА

МЕСТО УСТАНОВКИ

При выборе места для установки следует избегать:

- прямого воздействия солнечных лучей, дождя, высокой влажности или морского воздуха;
- воздействия легко воспламеняющихся или коррозионных газов или жидкостей;
- чрезмерной вибрации;
- попадания пыли, металлических частиц и масляного тумана;
- несоблюдения условий эксплуатации, приведенных в [таблицах А.1 и А.2](#).

ОБЩИЕ РЕКОМЕНДАЦИИ ПО МОНТАЖУ

Вес преобразователя см. в [таблицах А.1 и А.2](#).

Преобразователь следует устанавливать в вертикальном положении на плоской вертикальной поверхности.

Габаритные размеры и расположение установочных отверстий см. на [рис. 1](#).

Требования к минимальным расстояниям для обеспечения достаточной циркуляции охлаждающего воздуха см. на [рис. 2](#).

Примечание:

- Для размеров А, В и С допускается монтаж бок о бок без зазоров при условии снятия верхней крышки.

Не устанавливайте чувствительные к теплу компоненты непосредственно над преобразователем.

МОНТАЖ В ШКАФ

Поверхностный монтаж

Следует обеспечить достаточную вентиляцию, чтобы температура внутри шкафа оставалась в допустимых пределах, соответствующих требованиям к условиям эксплуатации преобразователя.

Значения рассеиваемой мощности при работе преобразователя в штатном режиме см. в [таблицах А.1 и А.2](#) в столбце «Рассеиваемая мощность [Вт] — поверхностный монтаж».

Минимальные требования к воздушному охлаждению шкафа см. в [таблице 1](#).

Расположение и диаметр монтажных отверстий см. на [рис. 1](#).

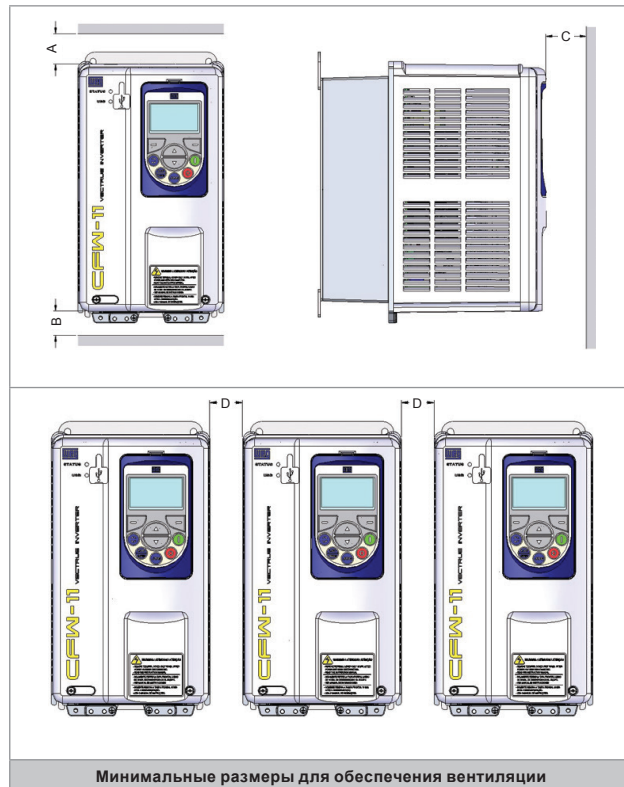

Минимальные размеры для обеспечения вентиляции

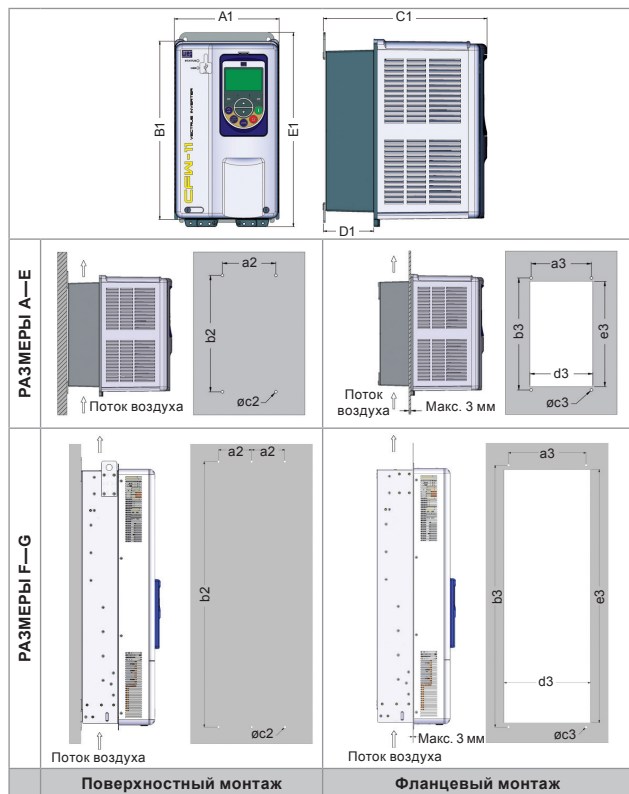

Поверхностный монтаж

Фланцевый монтаж

Модель	A1	B1	C1	D1	E1	a2	b2	c2	a3	b3	c3	d3	e3
	мм (дюймы)	мм (дюймы)	мм (дюймы)	мм (дюймы)	мм (дюймы)	мм (дюймы)	мм (дюймы)	М	мм (дюймы)	мм (дюймы)	М	мм (дюймы)	мм (дюймы)
Размер А	145 (5,71)	247 (9,73)	227 (8,94)	70 (2,75)	270 (10,63)	115 (4,53)	250 (9,85)	M5	130 (5,12)	240 (9,45)	M5	135 (5,32)	225 (8,86)
Размер В	190 (7,48)	293 (11,53)	227 (8,94)	71 (2,78)	316 (12,43)	150 (5,91)	300 (11,82)	M5	175 (6,89)	285 (11,23)	M5	179 (7,05)	271 (10,66)
Размер С	220 (8,67)	378 (14,88)	293 (11,53)	136 (5,36)	405 (15,95)	150 (5,91)	375 (14,77)	M6	195 (7,68)	365 (14,38)	M6	205 (8,08)	345 (13,59)
Размер D	300 (11,81)	504 (19,84)	305 (12,00)	135 (5,32)	550 (21,65)	200 (7,88)	525 (20,67)	M8	275 (10,83)	517 (20,36)	M8	285 (11,23)	485 (19,10)
Размер E	335 (13,19)	620 (24,41)	358 (14,09)	168 (6,61)	675 (25,57)	200 (7,88)	650 (25,59)	M8	275 (10,83)	635 (25,00)	M8	315 (12,40)	615 (24,21)
Размер F	430 (16,93)	1156 (45,51)	360 (14,17)	169 (6,65)	1234 (48,58)	150 (5,91)	1200 (47,24)	M10	350 (13,78)	1185 (46,65)	M10	391 (15,39)	1146 (45,12)
Размер G	535 (21,06)	1190 (46,85)	426 (16,77)	202 (7,95)	1264 (49,76)	200 (7,87)	1225 (48,23)	M10	400 (15,75)	1220 (48,03)	M10	495 (19,49)	1182 (46,53)

Допуск для d3 и e3: +1,0 мм
Общий допуск: ±1,0 мм

Рис. 1.: Габаритные размеры для монтажа

Модель	A	B	C	D		
	мм (дюймы)	мм (дюймы)	мм (дюймы)	мм (дюймы)		
Размер А	25 (0,98)	25 (0,98)	10 (0,39)	30 (1,18)		
Размер В	40 (1,57)	45 (1,77)				
Размер С	110 (4,33)	130 (5,12)				
Размер D			20 (0,78)	80 (3,15)		
Размер E	0142 T2	100 (3,94)			130 (5,12)	40 (1,57)
	0180 T2	150 (5,91)			250 (9,84)	80 (3,15)
	0211 T2					40 (1,57)
	0105 T4	100 (3,94)			130 (5,12)	40 (1,57)
	0142 T4					
0180 T4	150 (5,91)	250 (9,84)		80 (3,15)		
Размер F						
Размер G						

Допуск: ±1,0 мм

Рис. 2.: Минимальные размеры для обеспечения вентиляции преобразователя

Таблица 1.: Минимальные требования к воздушному охлаждению шкафа

Размер	Модель	Куб. футы в минуту	л/с	м³/мин
A	BCE	18	8	0,5
B	BCE	42	20	1,2
C	BCE	96	45	2,7
D	BCE	132	62	3,7
E	CFW11 0142 T 2	138	65	3,9
	CFW11 0180 T 2	265	125	7,5
	CFW11 0211 T 2			
	CFW11 0105 T 4	138	65	3,9
	CFW11 0142 T 4	180	95	5,1
F	CFW11 0180 T 4	265	125	7,5
	CFW11 0211 T 4			
	CFW11 0242 T 4	250	118	7,1
	CFW11 0312 T 4	320	151	9,1
	CFW11 0370 T 4	380	180	10,1
G	CFW11 0477 T 4	460	217	13
	CFW11 0515 T 4	680	321	19,3
	CFW11 0601 T 4			
	CFW11 0720 T 4			

Фланцевый монтаж

Потери энергии, указанные в [таблицах A.1 и A.2](#) в столбце «Рассеиваемая мощность [Вт] — фланцевый монтаж», обозначают только мощность, рассеиваемую внутри шкафа. Остальные потери энергии рассеиваются через заднюю сторону преобразователя.

Крепежные кронштейны и подъемные петли преобразователей размера E, F и G следует снять и переустановить, как показано на [рис. 3 и 4](#).

Находящаяся снаружи шкафа часть преобразователей размера A—E должна соответствовать степени защиты IP54. Степень защиты для размеров F и G — IP20.

Чтобы обеспечить соответствующую степень защиты шкафа, используйте подходящие прокладки (например, из силикона).

Размеры проема в монтажной поверхности, а также расположение и диаметры монтажных отверстий см. на [рис. 1](#).



Рис. 3.: Переустановка монтажных кронштейнов возможна для размеров A—E. На устройствах размера F и G монтажные кронштейны следует снять



Рис. 4.: Установка подъемных петель: размеры E, F и G

Доступ к клеммам питания и управления

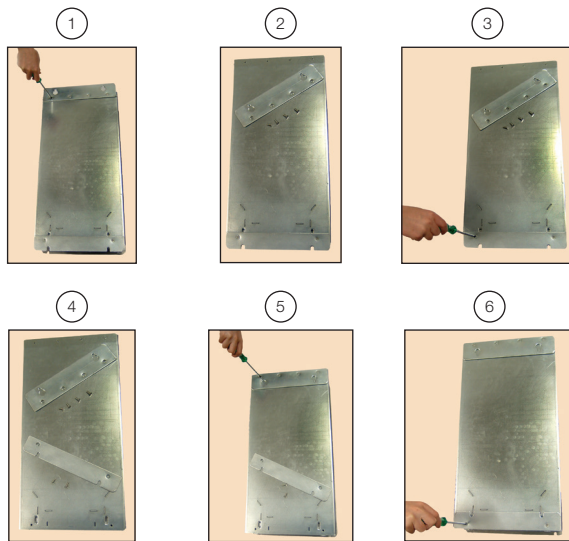
Чтобы получить доступ к клеммам питания и управления преобразователей размера A—C, снимите клавиатуру и крышку панели управления (см. [рис. 5](#)).

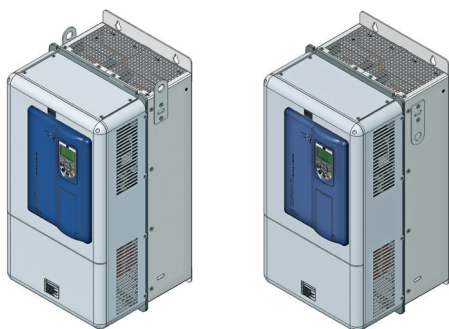

Рис. 5.: Снятие клавиатуры и крышки панели управления



Рис. 6.: Снятие клавиатуры и крышки панели управления на преобразователях размера D, E, F и G для доступа к клеммам управления

Чтобы получить доступ к клеммам питания преобразователей размера D—G, снимите нижнюю переднюю крышку, как показано на [рис. 7](#).

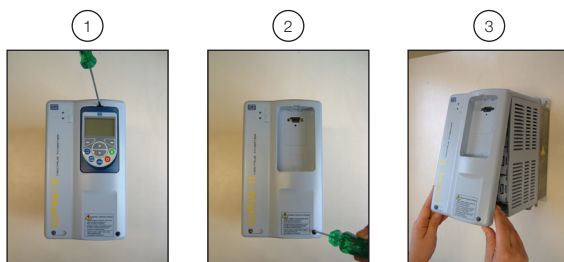

Рис. 7.: Снятие нижней передней крышки для доступа к клеммам питания преобразователей размера D—G

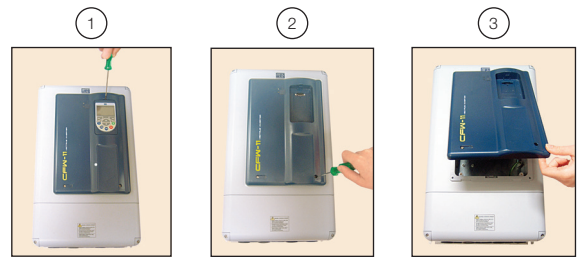
Если обеспечивать защиту степени IP20 или Nema1 для устройств размера D и E не требуется, разрешается снять нижнюю пластину с отверстиями для прокладки кабелей.

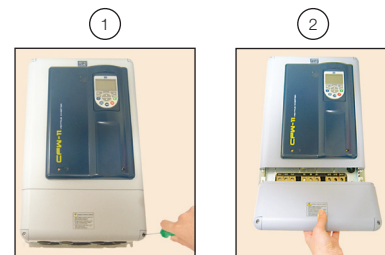

Рис. 8.: Снятие пластины с отверстиями для прокладки кабелей

На преобразователях размера F и G всегда следует снимать нижнюю пластину для подключения силовых кабелей (подачи питания и подключения электродвигателя), как показано на [рис. 9](#).

В данном случае степень защиты нижней части преобразователя снижается.

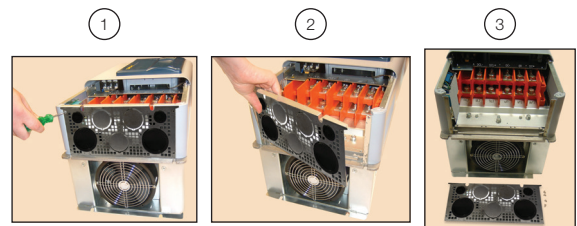

Рис. 9.: Снятие пластины с отверстиями для прокладки кабелей на устройствах размера F и G

ПОДКЛЮЧЕНИЕ ЭЛЕКТРООБОРУДОВАНИЯ



ВНИМАНИЕ!
Перед подключением убедитесь в том, что питание от сети переменного тока отключено.

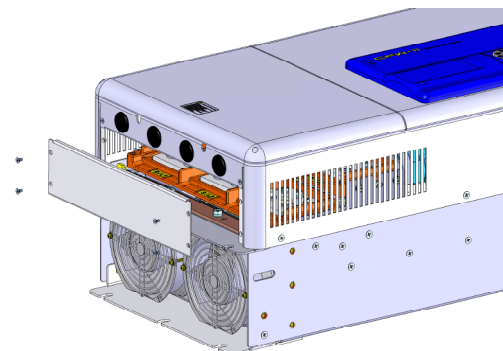

ВНИМАНИЕ!
Приведенная ниже информация представляет собой рекомендации по правильному подключению устройства. При выполнении работ по подключению электрооборудования соблюдайте требования соответствующих местных нормативных документов.



ВНИМАНИЕ!
Подключение электропитания к выходным клеммам приведет к выходу преобразователя из строя.

СХЕМЫ ПОДКЛЮЧЕНИЙ

Примечания

Технические спецификации, включая спецификации плавких линейных предохранителей, см. в [таблицах А.1 и А.2](#).

Технические спецификации тормозных резисторов и тормозных токов см. в [таблице А.3](#).



Рис. 10.: Схема подключения электропитания для стандартных устройств размера А, В, С, D, E, F и G



Рис. 11.: Схема подключения электропитания для устройств размера F и G со специальным оборудованием постоянного тока

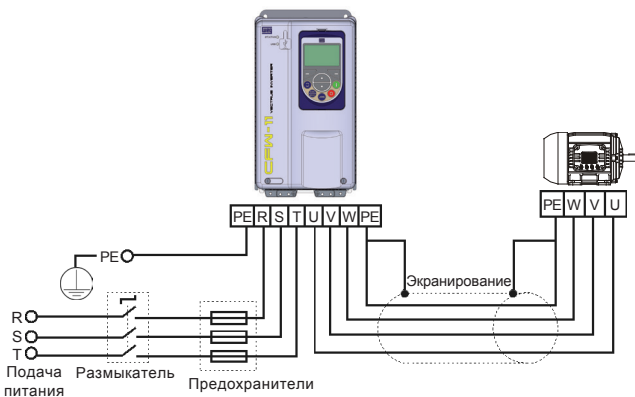

Рис. 12.: Схема подключения тормозного резистора для устройств размера А, В, С, D и E

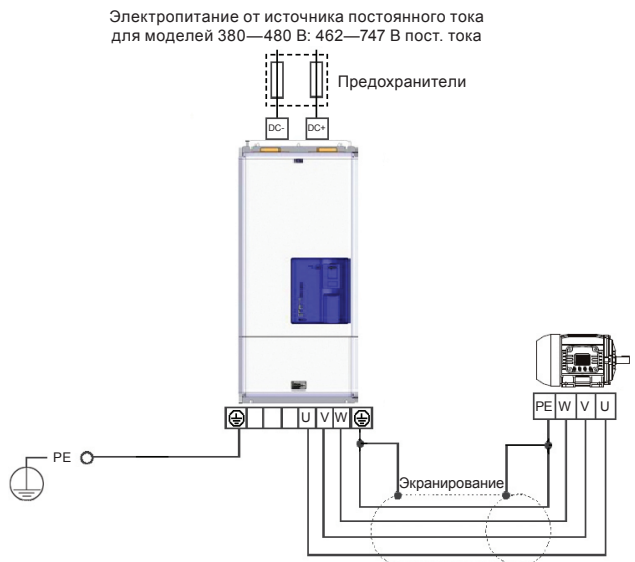

Рис. 13.: Схема подключения электропитания для стандартных устройств размера F и G с тормозным резистором

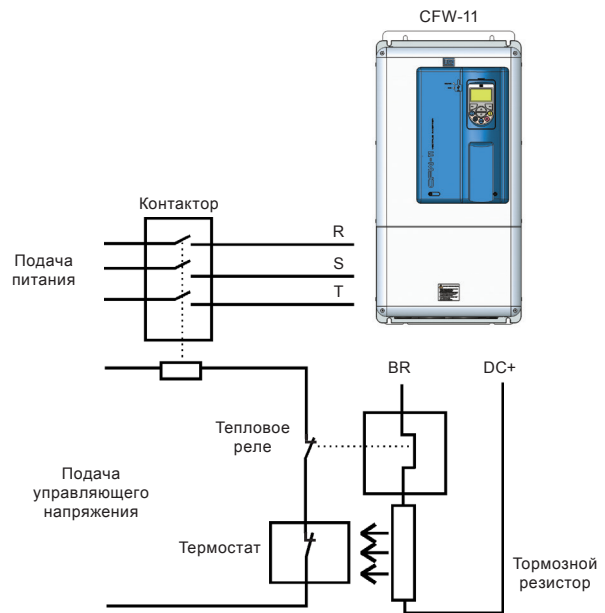

Рис. 14 (а).: Клеммы питания и заземления устройств размера А—С

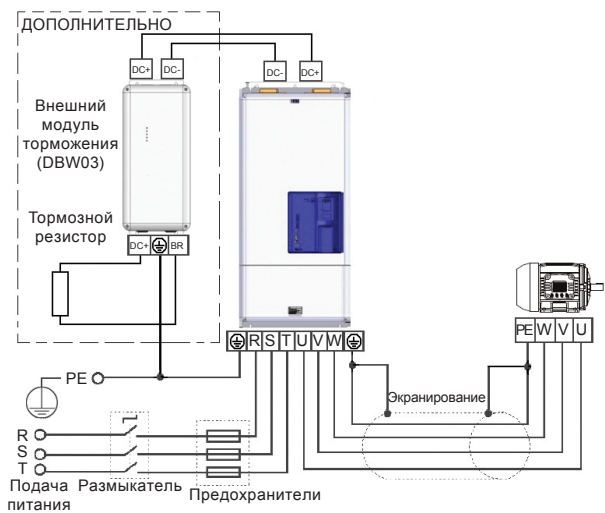

Заземление
(б) Размер D

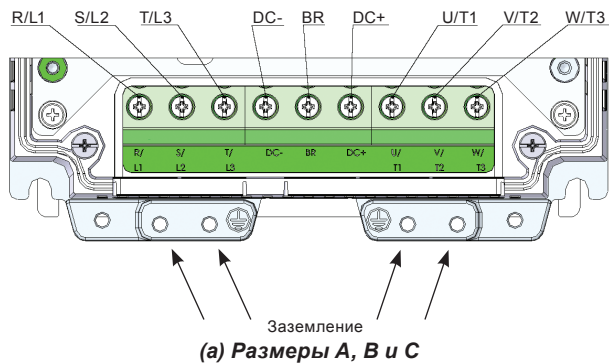
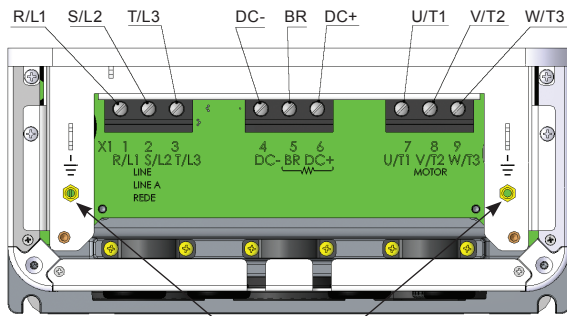
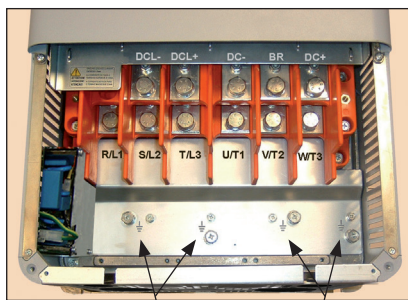

Заземление
(4xM8, 4xM5)
(в) Размер E

Рис. 14 (б) и (в): Клеммы питания и заземления устройств размера D—E

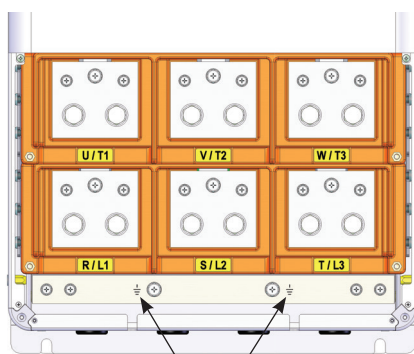

Заземление
(а) Стандартное устройство

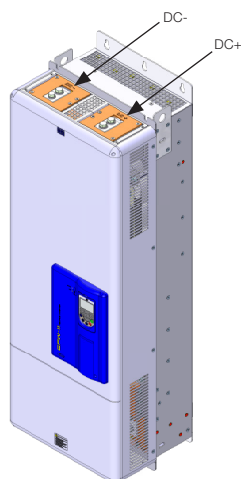

(б) Специальное оборудование постоянного тока

Рис. 15 (а) и (б): Клеммы питания и заземления устройств размера F и G



Рис. 16.: Подключение модуля динамического торможения к стандартным устройствам размера F и G

РЕКОМЕНДАЦИИ ПО ЭЛЕКТРИЧЕСКИМ ЦЕПЯМ И УСТРОЙСТВАМ

- Нейтраль источника электропитания преобразователя должна быть заземлена. Для сетей с изолированной нейтралью необходимо отключить некоторые внутренние компоненты преобразователя, как показано на [рис. 17—19](#).
- На входе электропитания преобразователя следует установить разъединитель. Его можно использовать для отключения электропитания преобразователя при необходимости (например, при обслуживании).
- Для защиты выпрямителя и электропроводки преобразователя используйте на входе высокоскоростные предохранители. При выборе соответствующего номинала предохранителя следует руководствоваться данными в [таблицах A.1 и A.2](#) (значение I_{2t} не должно превышать значение, указанное в таблицах с учетом значения холодного (не при плавлении) затухания тока).
- Чтобы обеспечить соответствие требованиям лаборатории по технике безопасности (США), используйте в цепи электропитания преобразователя предохранители класса J для токов, не превышающих указанные в [таблицах A.1 и A.2](#) значения.
- Кроме того, на входе электропитания могут использоваться стандартные предохранители. Эти предохранители должны быть рассчитаны на ток, превышающий номинальное значение входного тока в 1,2 раза. В данном случае предохранители обеспечивают защиту всего электрооборудования, кроме выпрямителя на входе преобразователя. Это может привести к повреждению преобразователя в случае неисправности какого-либо внутреннего компонента преобразователя.

ПОДКЛЮЧЕНИЕ ЦЕПЕЙ УПРАВЛЕНИЯ

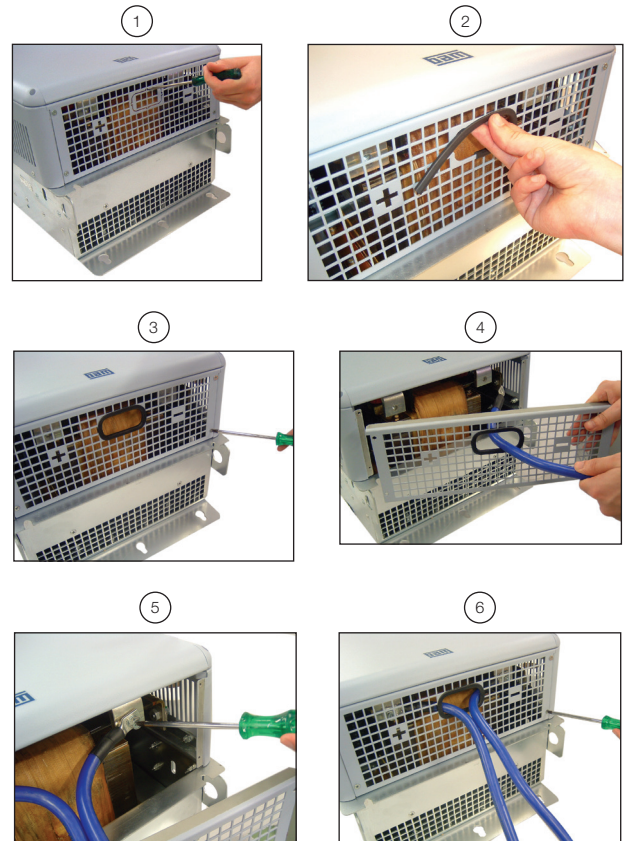
Подключение цепей управления (аналоговых входов и выходов, цифровых входов и выходов) осуществляется через клеммную колодку XC1 платы управления CC11.

Клеммная колодка XC1	Функция по умолчанию
1	REF+
2	AI1+
3	AI1-
4	REF-
5	AI2+
6	AI2-
7	AO1
8	AGND (24 В)
9	AO2
10	AGND (24 В)
11	DGND*
12	COM
13	24 В пост. тока
14	COM
15	DI1
16	DI2
17	DI3
18	DI4
19	DI5
20	DI6
21	NC1
22	C1
23	NO1
24	NC2
25	C2
26	NO2
27	NC3
28	C3
29	NO3



Рис. 21.: Сигналы на разъеме XC1. Цифровые входы работают в режиме активного высокого уровня.



ПРИМЕЧАНИЕ!

Для переключения в режим активного низкого уровня снимите перемычку между XC1:11 и XC1:12 и установите ее между XC1:12 и XC1:13, а затем подключите общие точки переключателей на цифровых входах DI1—DI6 к XC1:11 вместо XC1:13.

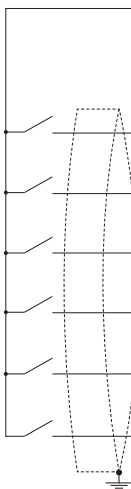
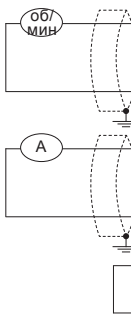
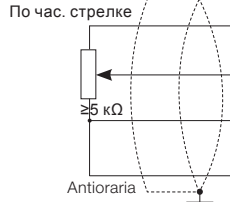
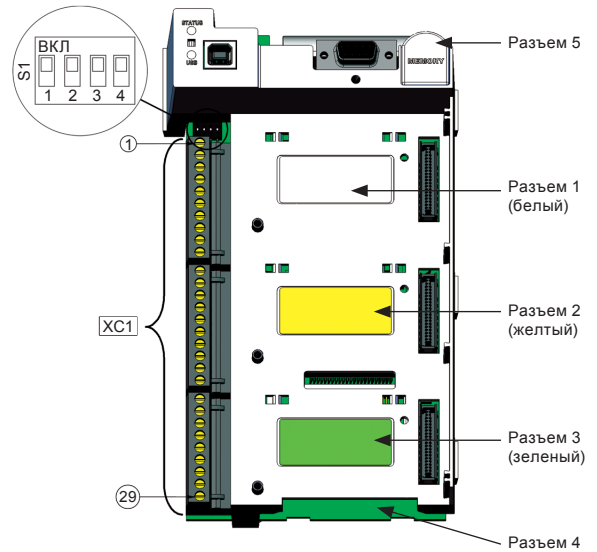

Сигнал	Функция по умолчанию	Положение DIP-переключателя	Режим	Заводская настройка
AI1	Уставка скорости (дистанционное управление)	S1.4	ВЫКЛ: 0—10 В (заводская настройка) ВКЛ: 4—20 мА/0—20 мА	ВЫКЛ
AI2	Не задействован	S1.3	ВЫКЛ: 0—±10 В (заводская настройка) ВКЛ: 4—20 мА/0—20 мА	ВЫКЛ
AO1	Скорость	S1.1	ВЫКЛ: 4—20 мА/0—20 мА ВКЛ: 0—10 В (заводская настройка)	ВКЛ
AO2	Ток двигателя	S1.2	ВЫКЛ: 4—20 мА/0—20 мА ВКЛ: 0—10 В (заводская настройка)	ВКЛ

Рис. 22.: DIP-переключатели для установки типа сигнала на аналоговых входах и выходах



ПРИМЕЧАНИЕ!

Дополнительные сведения о функции аварийного останова (STO) см. в Руководстве по установке, конфигурации и эксплуатации.

Типовые подключения цепей управления

Подключение цепей управления 1: управление функцией пуска и останова с клавиатуры (локальное управление)

Данный тип подключения цепей управления позволяет эксплуатировать преобразователь в режиме локального управления с заводскими настройками по умолчанию. Этот режим эксплуатации рекомендуется для начинающих пользователей, поскольку не требует дополнительных подключений.

Подключение цепей управления 2: двухпроводное управление функцией пуска и останова (дистанционное управление)

Данный тип подключения используется только с заводскими настройками по умолчанию при работе преобразователя в режиме дистанционного управления. При использовании заводских настроек по умолчанию выбор режима управления (местное или дистанционное) осуществляется с помощью клавиши **LOC/REM** на клавиатуре (по умолчанию установлен режим местного управления). Установите P0220=3, чтобы изменить настройку клавиши **LOC/REM** по умолчанию на дистанционный режим управления.



Рис. 23.: Схема разводки проводов на разъеме XC1 для подключения цепей управления 2

Подключение цепей управления 3: трехпроводное управление функцией пуска и останова

Позволяет управлять функцией пуска и останова с помощью трехпроводного управления. **Настройки параметров**
 Установите для DI3 значение START (ПУСК): P0265=6.
 Установите для DI4 значение STOP (ОСТАНОВ): P0266=7.
 Установите P0224=1 (DIx) для трехпроводного управления в режиме локального управления.
 Установите P0227=1 (DIx) для трехпроводного управления в режиме дистанционного управления.
 Установите направление вращения вперед/назад с помощью цифрового входа 2 (DI2).
 Установите P0223=4 для режима локального управления или P0226=4 для режима дистанционного управления.
 Кнопки S1 и S2 — пуск (нормально разомкнутый контакт) и останов (нормально замкнутый контакт) соответственно. Уставка скорости может быть задана через аналоговый вход (как при подключении цепей управления 2), с помощью клавиатуры (как при подключении цепей управления 1) или с помощью другого источника.

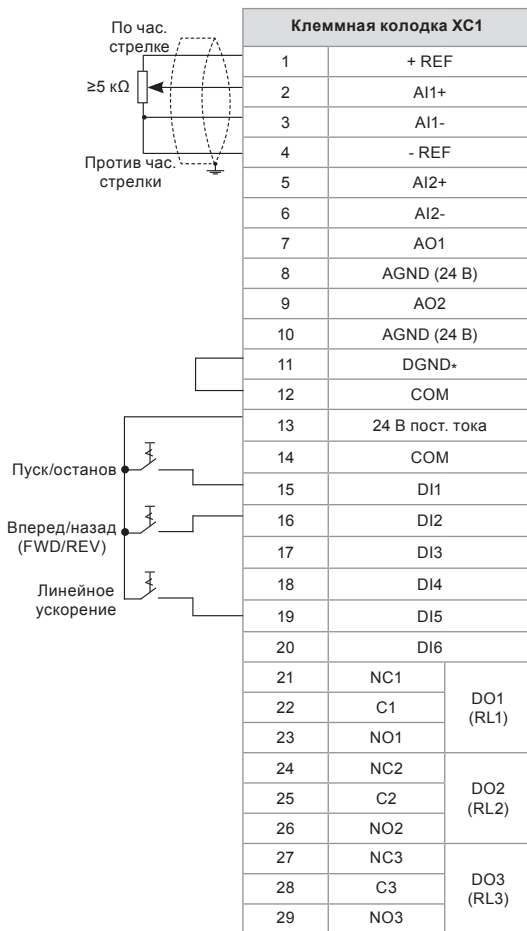

Рис. 24.: Схема разводки проводов на разъеме XC1 для подключения цепей управления 3

Подключение цепей управления 4: управление функцией направления вращения вперед/назад.

Позволяет управлять функцией направления вращения вперед/назад.

Настройки параметров

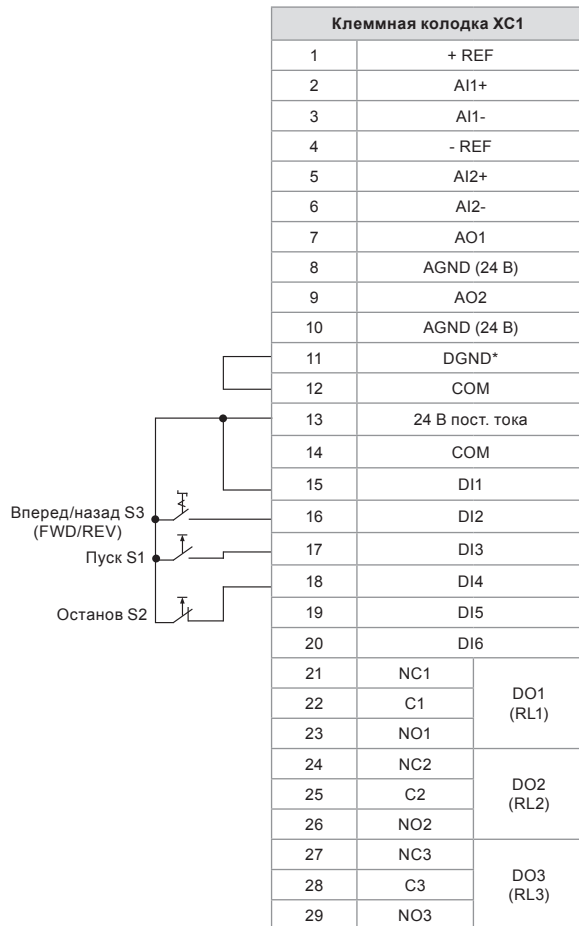
Установите DI3 для вращения вперед: P0265=4.

Установите DI4 для вращения назад: P0266=5.

После настройки функция направления вращения вперед/назад будет активна как в режиме локального управления, так и в режиме дистанционного управления. В то же время клавиши и на клавиатуре работать не будут (даже если P0224=0 или P0227=0).

Направление вращения определяется командами с входов на вращение вперед или назад.

Направление вращения вперед соответствует вращению по часовой стрелке, а направление вращения назад — против часовой стрелки.

Уставка скорости может быть задана с помощью любого устройства (как при подключении цепей управления 3).



Рис. 25.: Схема разводки проводов на разъеме XC1 для подключения цепей управления 4

УСТАНОВКА В СООТВЕТСТВИИ С ТРЕБОВАНИЯМИ ДИРЕКТИВЫ ЕС ПО ЭЛЕКТРОМАГНИТНОЙ СОВМЕСТИМОСТИ

Преобразователи размера А—D в исполнении FA (CFW11XXXXXOFA), а также все стандартные преобразователи других типоразмеров имеют встроенный фильтр радиопомех для снижения электромагнитных помех. Эти преобразователи при правильной установке соответствуют требованиям Директивы по электромагнитной совместимости 2004/108/ЕС.

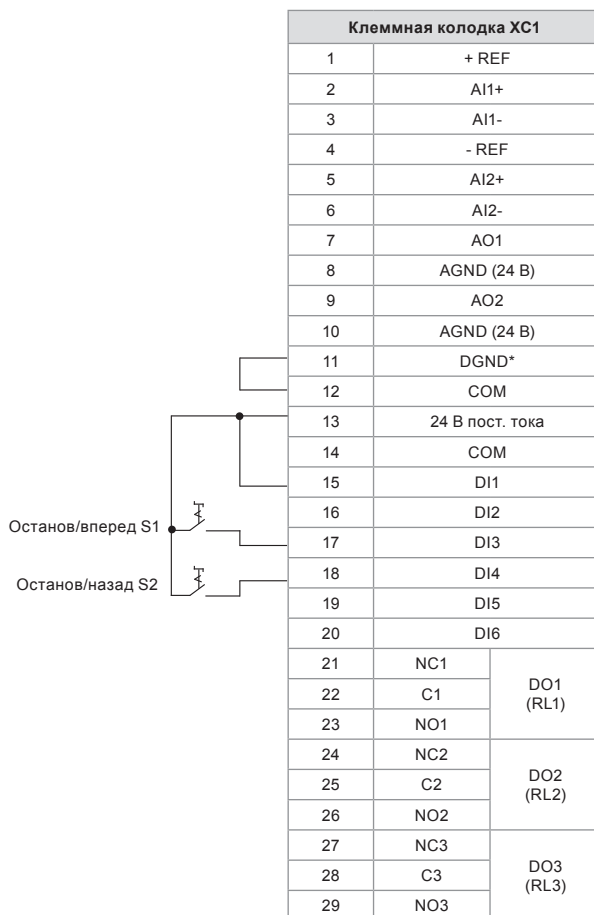

ВНИМАНИЕ!

Чтобы использовать модели со встроенными фильтрами радиопомех в сетях с изолированной нейтралью, выполните действия, показанные на рис. 17—19.

Установка в соответствии с требованиями

Для установки в соответствии с требованиями используйте указанное ниже оборудование.

- Преобразователи размера А—D со встроенными фильтрами радиопомех в исполнении CFW11XXXXXOFA или другие стандартные модели преобразователей.
- Экранированные выходные кабели (двигателя) с низкоомным соединением экрана по обоим сторонам (на двигателе и на преобразователе) для обеспечения высокой частоты. Максимальная длина кабеля двигателя, а также характеристики кабеля по уровням кондуктивного и радиального излучения должны соответствовать значениям, приведенным в [таблицах 2 и 3](#). Если требуется снизить уровень излучения или воспользоваться кабелем двигателя большей длины, следует установить на входе преобразователя внешний фильтр радиопомех. Дополнительные сведения о производителях фильтров радиопомех, допустимой длине кабеля двигателя и уровнях излучения см. в [таблицах 2 и 3](#).
- Экранированные кабели управления.
- Жесткое заземление преобразователя.

Таблица 2.: Уровни кондуктивного и радиального излучения преобразователей размера А—D

Модель преобразователя (со встроенным фильтром радиопомех)	Без внешнего фильтра радиопомех			С внешним фильтром радиопомех				
	Категория C3	Категория C2	Категория (металлический шкаф не требуется)	Кондуктивное излучение и максимальная длина кабеля двигателя	Радиальное излучение	Кондуктивное излучение и максимальная длина кабеля двигателя		Категория радиального излучения
						Категория C2	Категория C1	
	Без		Внутри		Категория радиального излучения			
металлического шкафа		металлического шкафа						
CFW11 0006 S2 O FA	100 м	7 м	C2	B84142-A16-R122	75 м	50 м	C2	C2
						B84142-B16-R		
CFW11 0007 T2 O FA	100 м	5 м	C2	B84143-G8-R110	100 м	-	C2	C2
						B84143-A8-R105		
CFW11 0007 S2 O FA	100 м	7 м	C2	B84142-A16-R122	75 м	50 м	C2	C2
						B84142-B16-R		
CFW11 0010 S2 O FA	100 м	7 м	C2	B84142-A30-R122	75 м	50 м	C2	C2
						B84142-B25-R		
CFW11 0010 T2 O FA	100 м	5 м	C2	B84143-G20-R110	100 м	-	C2	C2
						B84143-A16-R105		
CFW11 0013 T2 O FA	100 м	5 м	C2	B84143-G20-R110	100 м	-	C2	C2
						B84143-A16-R105		
CFW11 0016 T2 O FA	100 м	5 м	C2	B84143-G20-R110	100 м	-	C2	C2
						B84143-A25-R105		
CFW11 0024 T2 O FA	100 м	Нет	C2	B84143-A36-R105	100 м	100 м	C2	C2
CFW11 0028 T2 O FA	100 м	Нет	C2	B84143-A36-R105	100 м	100 м	C2	C2
CFW11 0033 T2 O FA	100 м	Нет	C2	B84143-A50-R105	100 м	100 м	C2	C2
CFW11 0045 T2 O FA	100 м	Нет	C3	B84143-A50-R105	100 м	100 м	C3	C2
CFW11 0054 T2 O FA	100 м	Нет	C3	B84143-A66-R105	100 м	100 м	C3	C2
CFW11 0070 T2 O FA	100 м	Нет	C3	B84143-A90-R105	100 м	100 м	C3	C2
CFW11 0086 T2 O FA	100 м	Нет	C3	B84143-A120-R105	100 м	100 м	C3	C2
CFW11 0105 T2 O FA	100 м	Нет	C3	B84143-A120-R105	100 м	100 м	C3	C2
CFW11 0003 T4 O FA	100 м	5 м	C2	B84143-G8-R110	100 м	-	C2	C2
						B84143-A8-R105		
CFW11 0005 T4 O FA	100 м	5 м	C2	B84143-G8-R110	100 м	-	C2	C2
						B84143-A8-R105		
CFW11 0007 T4 O FA	100 м	5 м	C2	B84143-G8-R110	100 м	-	C2	C2
						B84143-A8-R105		
CFW11 0010 T4 O FA	100 м	5 м	C2	B84143-G20-R110	100 м	-	C2	C2
						B84143-A16-R105		
CFW11 0013 T4 O FA	100 м	5 м	C2	B84143-G20-R110	100 м	-	C2	C2
						B84143-A16-R105		
CFW11 0017 T4 O FA	100 м	Нет	C2	B84143-A25-R105	100 м	100 м	C2	C2
CFW11 0024 T4 O FA	100 м	Нет	C2	B84143-A36-R105	100 м	100 м	C2	C2
CFW11 0031 T4 O FA	100 м	Нет	C2	B84143-A36-R105	100 м	100 м	C2	C2
CFW11 0038 T4 O FA	100 м	Нет	C3	B84143-A50-R105	100 м	100 м	C3	C2
CFW11 0045 T4 O FA	100 м	Нет	C3	B84143-A50-R105	100 м	100 м	C3	C2
CFW11 0058 T4 O FA	100 м	Нет	C3	B84143-A66-R105	100 м	100 м	C3	C2
CFW11 0070 T4 O FA	100 м	Нет	C3	B84143-A90-R105	100 м	100 м	C3	C2
CFW11 0088 T4 O FA	100 м	Нет	C3	B84143-A120-R105	100 м	100 м	C3	C2

Таблица 3.: Уровни кондуктивного и радиального излучения преобразователей размера Е—G

Модель преобразователя (со встроенным фильтром радиопомех)	Без внешнего фильтра радиопомех		С внешним фильтром радиопомех		
	Категория C3	Категория	Кондуктивное излучение и максимальная длина кабеля двигателя	Радиальное излучение	Категория радиального излучения
	Без		Внутри		Категория радиального излучения
металлического шкафа		металлического шкафа			
CFW11 0142 T2	100 м	C2	B84143-B0150-S020	100 м	C2
CFW11 0180 T2	100 м	C2	B84143-B0180-S020 (1)	100 м	C2
CFW11 0211 T2	100 м	C2	B84143-B0250-S020 (2)	100 м	C2
CFW11 0105 T4	100 м	C2	B84143-B0150-S020	100 м	C2
CFW11 0142 T4	100 м	C2	B84143-B0150-S020	100 м	C2
CFW11 0180 T4	100 м	C2	B84143-B0180-S020 (1)	100 м	C2
CFW11 0211 T4	100 м	C2	B84143-B0250-S020 (2)	100 м	C2
CFW11 0242 T4	100 м	C3 (3)	B84143-B0250-S021	100 м (4)	C3
CFW11 0312 T4	100 м	C3 (3)	B84143-B01420-S021	100 м (4)	C3
CFW11 0370 T4	100 м	C3 (3)	B84143-B0400-S021	100 м (4)	C3
CFW11 0477 T4	100 м	C3 (3)	B84143-B0600-S021	100 м (4)	C3
CFW11 0515 T4	100 м	C3 (3)	B84143-B0600-S021	100 м (4)	C3
CFW11 0601 T4	100 м	C3 (3)	B84143-B0600-S021	100 м (4)	C3
CFW11 0720 T4	100 м	C3 (3)	B84143-B1000-S021	100 м (4)	C3

Примечания к таблице 3:

(1) Если температура окружающего воздуха вблизи преобразователя или фильтра превышает 40 °C и выходной ток при длительной работе больше 172 А, необходимо использовать фильтр B84143B0250S020.

(2) Если оборудование эксплуатируется в тяжелых условиях (циклы с большой нагрузкой, выходной ток < 180 А) и температура окружающего воздуха вблизи преобразователя или фильтра превышает 40 °C, можно использовать фильтр B84143B0180S020.

(3) С торoidalным сердечником в трех кабелях подачи электропитания. Пример: TDK PN: PC40 UU120x160x20.

(4) Минимальная рабочая частота 2,5 Гц.

ВСТРОЕННАЯ КЛАВИАТУРА NMI-CFW11

Левая функциональная клавиша, функция которой определяется текстом над клавишей на дисплее.

Правая функциональная клавиша, функция которой определяется текстом над клавишей на дисплее.

1. Увеличение значения параметра.
2. Увеличение скорости.
3. Выбор предыдущей группы в списке группы параметров.

1. Уменьшение значения параметра.
2. Снижение скорости.
3. Выбор следующей группы в списке группы параметров.

Управление направлением вращения двигателя. Действует при P0223=2 или 3 в режиме LOC и/или P0226=2 или 3 в режиме REM.

Линейное ускорение двигателя. Действует при P0224=0 в режиме LOC и/или P0227=0 в режиме REM.

Выбор режима локального (LOC) или дистанционного (REM) управления. Действует при P0220=2 или 3.

Линейное замедление двигателя до полного останова. Действует при P0224=0 в режиме LOC и/или P0227=0 в режиме REM.

При нажатии клавиши происходит линейное ускорение двигателя до скорости, заданной значением параметра P0122. Пока клавиша нажата, скорость двигателя поддерживается на заданном уровне. При отпускании клавиши происходит линейное замедление двигателя до полного останова. Действует при выполнении всех описанных ниже условий.
1. Пуск/останов=останов.
2. Общее включение=активно.
3. P0225=1 в режиме LOC и/или P0228=1 в режиме REM.

Рис. 26.: Внешний вид и функции клавиатуры



Рис. 27.: Дисплей клавиатуры и пример отображения функций по умолчанию (режим контроля)



Рис. 28.: Крышка аккумуляторной батареи клавиатуры для доступа к батарее

Информация о клавиатуре

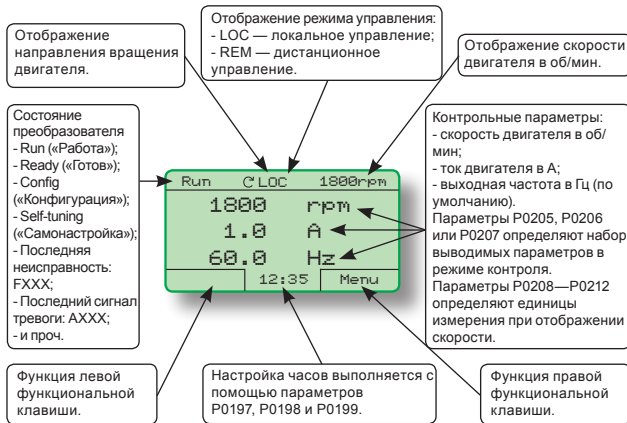
- Поддерживает возможность «горячей» замены.
- Поддерживает программирование других типов экранов контроля с использованием гистограмм и шрифтов большого размера путем настройки параметров P0205-207 и P0208-212.
- Аккумуляторная батарея используется только для питания внутренних часов при отключенном преобразователе. Если батарея полностью разряжена или не установлена, время будет отображаться неверно и при каждом включении преобразователя на дисплей будет выводиться сообщение об ошибке A181 - Invalid clock time («A181 — неверное время»).
- Утилизируйте батарею после полной разрядки в соответствии с требованиями местных нормативных документов.

СТРУКТУРА ПАРАМЕТРОВ

При нажатии правой функциональной клавиши MENU («Меню») в режиме контроля на дисплей выводится первая группа параметров. В зависимости от версии программного обеспечения номера и названия групп параметров могут отличаться.

ЗАПУСК



ВНИМАНИЕ!

Подключение электропитания к выходным клеммам приведет к выходу преобразователя из строя.

ДЕЙСТВИЯ ПЕРЕД ПОДАЧЕЙ ЭЛЕКТРОПИТАНИЯ

- 1) Проверьте правильность и надежность подключения электропитания, заземления и цепей управления.
- 2) Удалите из преобразователя или шкафа все материалы, оставшиеся после завершения монтажа.
- 3) Проверьте подключение двигателя и соответствие параметров напряжения и тока номинальным значениям параметров преобразователя.
- 4) Отсоедините нагрузку от двигателя. Если отсоединить нагрузку от двигателя нельзя, убедитесь в том, что направление вращения (вперед или назад) не приведет к травмированию персонала и повреждению оборудования.
- 5) Закройте крышку преобразователя или дверцы шкафа.
- 6) Измерьте напряжение электропитания и убедитесь в том, что оно находится в допустимых пределах.
- 7) Подайте электропитание на преобразователь, замкнув установленный на входе разъединитель.
- 8) Проверьте результат первого запуска по указанным ниже признакам.

На дисплее клавиатуры отображается стандартный экран режима контроля, а светодиодный индикатор состояния светится, не мигая, зеленым цветом.

ЗАПУСК В РЕЖИМЕ V/F

Процедура запуска в режиме V/f с помощью процедуры Oriented Start-up («Упрощенный запуск») и группы параметров Basic Application («Основное приложение») описана в трех действиях ниже.

1) Настройка пароля P0000

Шаг	Действие и результат	Индикация на дисплее
1	— Режим контроля. — Нажмите клавишу Menu («Меню») (правая функциональная клавиша).	Ready C LOC 0rpm 0 rpm 0.0 A 0.0 Hz 15:45 Menu
2	— Выбрана группа 00 ALL PARAMETERS («00 Все параметры»). — Нажмите клавишу Select («Выбрать»).	Ready C LOC 0rpm 00 ALL PARAMETERS 01 PARAMETER GROUPS 02 ORIENTED START-UP 03 CHANGED PARAMETERS Return 15:45 Select
3	— Выбран параметр Access to Parameters P0000: 0 («Доступ к параметрам: P0000: 0») — Нажмите клавишу Select («Выбрать»).	Ready C LOC 0rpm Access to Parameters P0000: 0 Speed Reference P0001: 90 rpm Return 15:45 Select
4	— Чтобы установить пароль, нажимайте клавишу  до тех пор, пока на дисплее не появится цифра 5.	Ready C LOC 0rpm P0000 Access to Parameters 0 Return 15:45 Save
5	— Когда на дисплее отображается цифра 5, нажмите клавишу Save («Сохранить»).	Ready C LOC 0rpm P0000 Access to Parameters 5 Return 15:45 Save
6	— Если настройка была выполнена правильно, на дисплее должно отображаться сообщение Access to Parameters P0000: 5 («Доступ к параметрам: P0000: 5») — Нажмите клавишу Return («Возврат») (левая функциональная клавиша).	Ready C LOC 0rpm Access to Parameters P0000: 5 Speed Reference P0001: 90 rpm Return 15:45 Select
7	— Нажмите клавишу Return («Возврат»).	Ready C LOC 0rpm 00 ALL PARAMETERS 01 PARAMETER GROUPS 02 ORIENTED START-UP 03 CHANGED PARAMETERS Return 15:45 Select
8	— Дисплей возвращается в режим контроля.	Ready C LOC 0rpm 0 rpm 0.0 A 0.0 Hz 15:45 Menu

Рис. 29.: Порядок разрешения изменения параметров путем настройки параметра P0000

2) Упрощенный запуск

Группа параметров Oriented Start-up («Упрощенный запуск») облегчает настройку параметров преобразователя. Параметр P0317 в данной группе параметров позволяет начать процедуру упрощенного запуска.

При упрощенном запуске на дисплей клавиатуры в логической последовательности выводятся основные параметры. Эта процедура позволяет выполнить настройку минимально необходимого набора параметров для правильной эксплуатации преобразователя. При этом вводятся такие данные, как напряжение электропитания и характеристики двигателя (в соответствии с данными на паспортной табличке двигателя).

Чтобы начать процедуру упрощенного запуска, необходимо сначала установить для параметра P0317 значение 1, а затем настроить все остальные параметры по мере их вывода на дисплей.

При программировании параметров процедуры упрощенного запуска происходит автоматическое изменение настроек других параметров и внутренних переменных преобразователя.

При выполнении процедуры упрощенного запуска в левом верхнем углу дисплея отображается сообщение о состоянии Config («Конфигурация»).

3) Настройки параметров основного приложения

После выполнения процедуры упрощенного запуска и соответствующей настройки параметров преобразователь готов к эксплуатации в режиме V/f.

Группа параметров Basic Application («Основное приложение») содержит некоторые общие параметры приложения.

УСТАНОВКА ДАТЫ И ВРЕМЕНИ

Выберите соответствующую группу и настройте следующие параметры: день (P0194), месяц (P0195) и год (P0196); время — часы (P0197), минуты (P0198) и секунды (P0199).

ЗАПРЕТ ИЗМЕНЕНИЯ ПАРАМЕТРОВ

Чтобы предотвратить несанкционированное или непреднамеренное изменение параметров, установите для параметра P0000 любое значение, отличное от 5.

ФУНКЦИИ МОДУЛЯ ФЛЭШ-ПАМЯТИ

- Хранение копии настроек параметров преобразователя.
- Передача сохраненных параметров во флэш-память преобразователя.
- Передача сохраненного ПО во флэш-память преобразователя.
- Хранение программы, созданной с помощью SoftPLC.

При подаче электропитания на преобразователь данная программа (SoftPLC) записывается в оперативную память преобразователя и выполняется.

Дополнительные сведения см. в Руководстве по программированию CFW-11 и в Руководстве по SoftPLC.

ПРИЛОЖЕНИЕ 1. ТЕХНИЧЕСКИЕ СПЕЦИФИКАЦИИ

Таблица А.1.: Технические спецификации устройств размера А—D

Модель	Размер	Количество силовых фаз	Эксплуатация в нормальном режиме (ND)										Эксплуатация в режиме высокой мощности (HD)										Входная мощность [Вт]	Вес [кг]	Предохранитель в соответствии с европейским стандартом IEC, [А]	Предохранитель, It [А°с] при 25 °С	Температура окружающего воздуха [°С]	Динамическое торможение	Степень защиты корпуса	Фильтр радиопомех	Аварийный останов	Электропитание 24 В пост. тока от внешнего источника	Наличие комплектов дополнительного встраиваемого оборудования
			Номинальный выходной ток [А]	Ток перегрузки [А]		Номинальная несущая частота [кГц]	Максимальная мощность двигателя [л.с./кВт]	Номинальный входной ток [А]	Рассеиваемая мощность [Вт]		Номинальный выходной ток [А]	Ток перегрузки [А]		Номинальная несущая частота [кГц]	Максимальная мощность двигателя [л.с./кВт]	Номинальный входной ток [А]	Рассеиваемая мощность [Вт]																
1 мин		3 с		1 мин					3 с			1 мин					3 с																
CFW11 0006 B 2	А	1ø/3ø	6	6,6	9	5	1,5/1,1	12,3/6	130	25	5	7,5	10	5	1,5/1,1	10,3/5	120	25	5,7/12,6	15	420	Встроен.	-10—50 °С (14—122)	Встроен.	None 1 (изоляционный комплект для устройств размера А)	Да	Да	Да	Да	Да	Да		
CFW11 0006 S 2 O FA		1ø	6	6,6	9	5	1,5/1,1	12,3	130	25	5	7,5	10	5	1,5/1,1	10,3	120	25	5,7/12,6	15	420												
CFW11 0007 T 2		3ø	7	7,7	10,5	5	2/1,5	7	140	25	5,5	8,25	11	5	1,5/1,1	5,5	120	25	5,7/12,6	15	420												
CFW11 0007 B 2		1ø/3ø	7	7,7	10,5	5	2/1,5	14,4/7	140	25	7	10,5	14	5	2/1,5	14,4/7	140	25	6,1/13,4	20(10ø)/15(3ø)	420												
CFW11 0007 S 2 O FA		1ø	7	7,7	10,5	5	2/1,5	14,4	140	25	7	10,5	14	5	2/1,5	14,4	140	25	6,1/13,4	15	420												
CFW11 0010 T 2		3ø	10	11	15	5	3/2,2	10	170	30	8	12	16	5	2/1,5	8	170	30	5,7/12,6	15	420												
CFW11 0010 S 2		1ø	10	11	15	5	3/2,2	20,5	180	30	10	15	20	5	3/2,2	20,5	140	25	6,1/13,4	25	1000												
CFW11 0013 T 2		3ø	13	14,3	19,5	5	4/3,0	13	200	30	11	16,5	22	5	3/2,2	11	170	30	6,1/13,4	20	420												
CFW11 0016 T 2		3ø	16	17,6	24	5	5/3,7	16	230	30	13	19,5	26	5	4/3,0	13	190	30	6,3/13,9	25	420												
CFW11 0024 T 2		3ø	24	26,4	36	5	7,5/5,5	24	310	50	20	30	40	5	6/4,5	20	250	40	9,1/20	25	1000												
CFW11 0028 T 2		3ø	28	30,8	42	5	10/7,5	28	370	60	24	36	48	5	7,5/5,5	24	290	40	9,1/20	35	1000												
CFW11 0033 T 2		3ø	33,5	36,9	50,3	5	12,5/9,2	33,5	430	60	28	42	56	5	10/7,5	28	350	50	9,1/20	30	1000												
CFW11 0045 T 2	3ø	45	49,5	67,5	5	15/11	45	590	90	36	54	72	5	12,5/9,2	36	450	70	15,6/34,4	50	2750													
CFW11 0054 T 2	3ø	54	59,4	81	5	20/15	54	680	100	45	67,5	90	5	15/11	45	540	80	16,0/35,3	70	2750													
CFW11 0070 T 2	3ø	70	77	105	5	25/18,5	70	900	140	56	84	112	5	20/15	56	680	100	17,9/39,5	80	2750													
CFW11 0088 T 2	3ø	86	94,6	129	5	30/22	86	970	150	70	105	140	5	25/18,5	70	740	110	29,5/65,1	100	3150													
CFW11 0105 T 2	3ø	105	116	158	5	40/30	105	1200	180	86	129	172	5	30/22	86	920	140	31,4/69,2	125	3150													
CFW11 0003 T 4	А	3ø	3,6	3,96	5,40	5	2/1,5	3,6	130	25	3,6	5,4	7,2	5	2/1,5	3,6	110	25	5,7/12,6	15	190	Встроен.	-10—50 °С (14—122)	Встроен.	None 1 (изоляционный комплект для устройств размера А)	Да	Да	Да	Да	Да	Да		
CFW11 0005 T 4		3ø	5	5,5	7,5	5	3/2,2	5	140	25	5	7,5	10	5	3/2,2	5	140	25	5,9/13	15	190												
CFW11 0007 T 4		3ø	7	7,7	10,5	5	4/3	7	180	30	5,5	8,25	11	5	3/2,2	5,5	140	25	5,9/13	15	190												
CFW11 0010 T 4		3ø	10	11	15	5	6/4,5	10	220	30	10	15	20	5	6/4,5	10	200	30	6,1/13,4	15	495												
CFW11 0013 T 4		3ø	13,5	14,9	20,3	5	7,5/5,5	13,5	280	40	11	16,5	22	5	6/4,5	11	220	30	6,3/13,9	20	495												
CFW11 0017 T 4		3ø	17	18,7	25,5	5	10/7,5	17	360	50	13,5	20,3	27	5	7,5/5,5	13,5	270	40	9,1/20	25	495												
CFW11 0024 T 4		3ø	24	26,4	36	5	15/11	24	490	70	19	28,5	38	5	10/7,5	19	360	50	9,7/21,4	35	500												
CFW11 0031 T 4		3ø	31	34,1	46,5	5	20/15	31	560	80	25	37,5	50	5	15/11	25	430	60	10,4/22,9	35	1250												
CFW11 0038 T 4		3ø	38	41,8	57	5	25/18,5	38	710	110	33	49,5	66	5	20/15	33	590	90	16,4/36,2	50	1250												
CFW11 0045 T 4		3ø	45	49,5	67,5	5	30/22	45	810	120	38	57	76	5	25/18,5	38	650	100	19,6/43,2	50	2100												
CFW11 0058 T 4		3ø	58,5	64,4	87,8	5	40/30	58,5	1050	160	47	70,5	94	5	30/22	47	800	120	20,5/45,2	70	2100												
CFW11 0070 T 4		3ø	70,5	77,6	106	5	50/37	70,5	1280	190	61	91,5	122	5	40/30	61	1050	160	31,1/68,6	80	2100												
CFW11 0088 T 4	3ø	88	96,8	132	5	60/45	88	1480	220	73	110	146	5	50/37	73	1170	180	32,6/71,8	100	3150													

Модели с электропитанием 200—240 В

Модели с электропитанием 380—480 В

Таблица А.2.: Технические спецификации устройств размера E—G

Модель	Размер	Количество силовых фаз	Эксплуатация в нормальном режиме (ND)										Эксплуатация в режиме высокой мощности (HD)										Вес [кг]	Предохранитель в соответствии с европейским стандартом IEC, [A]	Предохранитель, I ² t [A ² с] при 25 °C	Температура окружающего воздуха [°C]	Динамическое торможение	Степень защиты корпуса	Фильтр радиопомех	Аварийный останов	Электропитание 24 В пост. тока от внешнего источника	Наличие комплектов дополнительного встраиваемого оборудования
			Номинальный выходной ток ⁽¹⁾ [A]	Ток перегрузки ⁽²⁾ [A]	Номинальная несущая частота [кГц]	Максимальная мощность двигателя [л.с./кВт]	Номинальный входной ток [A]	Рассеиваемая мощность [Вт]	Фланцевый монтаж	Поверхностный монтаж	Номинальный выходной ток ⁽¹⁾ [A]	Ток перегрузки ⁽²⁾ [A]	Номинальная несущая частота [кГц]	Максимальная мощность двигателя [л.с./кВт]	Номинальный входной ток [A]	Рассеиваемая мощность [Вт]	Фланцевый монтаж	Поверхностный монтаж														
CFW11 0142 T 2	E	3φ	142	156,2	213	2,5	50/37	142	1490	210	115	172,5	230	5	40/30	115	1280	200	39200	-10...45 (14... 113)	По заказу (в стандартном исполнении функция динамического торможения отсутствует)	Непа 1 (комплект KN1E-01)	Встроен.	Да	Да	Непа 1 (комплект KN1E-01)						
CFW11 0180 T 2			180	198	270	2,5	60/45	180	1820	360	142	213	284	5	50/37	142	1550	350	218000	-10...45 (14... 113)	По заказу (в стандартном исполнении функция динамического торможения отсутствует)	Непа 1 (комплект KN1E-02)	Встроен.	Да	Да	Непа 1 (комплект KN1E-02)						
CFW11 0211 T 2			211	232	317	2,5	75/55	211	2040	360	180	270	360	2,5	75/55	180	1690	350	218000	-10...45 (14... 113)	По заказу (в стандартном исполнении функция динамического торможения отсутствует)	Непа 1 (комплект KN1E-01)	Встроен.	Да	Да	Непа 1 (комплект KN1E-01)						
CFW11 0105 T 4			105	115,5	157,5	2,5	75/55	105	1270	200	88	132	176	2,5	60/45	88	1020	190	39200	-10...45 (14... 113)	По заказу (в стандартном исполнении функция динамического торможения отсутствует)	Непа 1 (комплект KN1E-01)	Встроен.	Да	Да	Непа 1 (комплект KN1E-01)						
CFW11 0142 T 4	E	3φ	142	156,2	213	2,5	100/75	142	1680	210	115	172,5	230	2,5	75/55	115	1290	200	39200	-10...45 (14... 113)	По заказу (в стандартном исполнении функция динамического торможения отсутствует)	Непа 1 (комплект KN1E-01)	Встроен.	Да	Да	Непа 1 (комплект KN1E-01)						
CFW11 0180 T 4			180	198	270	2,5	150/110	180	2050	360	142	213	284	2,5	100/75	142	1570	350	218000	-10...45 (14... 113)	По заказу (в стандартном исполнении функция динамического торможения отсутствует)	Непа 1 (комплект KN1E-02)	Встроен.	Да	Да	Непа 1 (комплект KN1E-02)						
CFW11 0211 T 4			211	232,1	317	2,5	175/132	211	2330	360	180	270	360	2,5	150/110	180	1940	350	218000	-10...45 (14... 113)	По заказу (в стандартном исполнении функция динамического торможения отсутствует)	Непа 1 (комплект KN1E-02)	Встроен.	Да	Да	Непа 1 (комплект KN1E-02)						
CFW11 0242 T 4			242	266	363	2,5	200/150	242	1518	285	211	317	422	2,5	175/132	211	1277	227	320000	-10...45 (14... 113)	По заказу (в стандартном исполнении функция динамического торможения отсутствует)	Непа 1 (комплект KN1E-02)	Встроен.	Да	Да	Непа 1 (комплект KN1E-02)						
CFW11 0312 T 4	F	3φ	312	343	468	2,5	250/185	312	2034	375	242	363	484	2,5	200/150	242	1507	292	414000	-10...45 (14... 113)	По заказу (в стандартном исполнении функция динамического торможения отсутствует)	Непа 1 (комплект KN1E-02)	Встроен.	Да	Да	Непа 1 (комплект KN1E-02)						
CFW11 0370 T 4			370	407	555	2,5	300/220	370	2497	407	312	468	624	2,5	250/185	312	2008	320	414000	-10...45 (14... 113)	По заказу (в стандартном исполнении функция динамического торможения отсутствует)	Непа 1 (комплект KN1E-02)	Встроен.	Да	Да	Непа 1 (комплект KN1E-02)						
CFW11 0477 T 4			477	525	716	2,5	400/300	477	3273	595	370	555	740	2,5	300/220	370	2451	465	1051000	-10...45 (14... 113)	По заказу (в стандартном исполнении функция динамического торможения отсутствует)	Непа 1 (комплект KN1E-02)	Встроен.	Да	Да	Непа 1 (комплект KN1E-02)						
CFW11 0515 T 4			515	567	773	2	400/300	515	3338	769	477	716	954	2	400/300	477	2987	644	1445000	-10...45 (14... 113)	По заказу (в стандартном исполнении функция динамического торможения отсутствует)	Непа 1 (комплект KN1E-02)	Встроен.	Да	Да	Непа 1 (комплект KN1E-02)						
CFW11 0601 T 4	G	3φ	601	662	900	2	500/370	601	3875	781	515	773	1030	2	400/300	515	3219	639	1445000	-10...45 (14... 113)	По заказу (в стандартном исполнении функция динамического торможения отсутствует)	Непа 1 (комплект KN1E-02)	Встроен.	Да	Да	Непа 1 (комплект KN1E-02)						
CFW11 0720 T 4			720	792	1080	2	600/440	720	4576	858	560	840	1120	2	450/330	560	3747	653	1445000	-10...40 (14... 104)	По заказу (в стандартном исполнении функция динамического торможения отсутствует)	Непа 1 (комплект KN1E-02)	Встроен.	Да	Да	Непа 1 (комплект KN1E-02)						

Модели с электропитанием 380—440 В

Примечания

- (1) Номинальный ток в состоянии равновесия приведен для указанных ниже условий.
- Номинальные частоты переключения.
- Температура окружающего воздуха соответствует значениям, приведенным в таблице. При повышении температуры не более чем на 10 °C по сравнению с максимальным указанным в таблице номинальным значением следует снижать значение выходного тока на 2 % на каждый градус превышения.
- Относительная влажность воздуха: 5—90 %, без образования конденсата.
- Высота над уровнем моря: 1000 м. Для высоты над уровнем моря в диапазоне от 1000 до 4000 м следует снижать значение выходного тока на 1 % на каждые 100 м превышения высоты 1000 м.
- Окружающая среда имеет степень загрязнения 2 (при изменении в соответствии с требованиями стандартов EN50178 и UL508С).
- (2) Номинальные значения мощности двигателя имеют исключительно рекомендательный характер для четырехполюсных двигателей WEG на 230 В или 460 В. Подбор соответствующего размера преобразователя должен выполняться на основе номинального тока используемого двигателя.

Таблица А.3.: Спецификации динамического торможения для устройств размера А—Е

Модель преобразователя	Максимальный тормозной ток (I _{макс}) [А]	Максимальная тормозная мощность (пиковое значение) (P _{макс}) ⁽²⁾ [кВт]	Эффективный тормозной ток (I _{эффект}) ⁽¹⁾ [А]	Рассеиваемая мощность тормозного резистора (среднее значение) (P _р) ⁽²⁾ [кВт]	Рекомендуемый резистор [Ω]	Сечение силового провода (клеммы DC+ и BR) [мм ² (AWG)]
CFW11 0006 B 2	5,3	2,1	5,2	2,03	75	1,5 (16)
CFW11 0006 S 2 O FA	5,3	2,1	5,2	2,03	75	1,5 (16)
CFW11 0007 B 2	7,1	2,9	6,96	2,71	56	1,5 (16)
CFW11 0007 S 2 O FA	7,1	2,9	6,96	2,71	56	1,5 (16)
CFW11 0007 T 2	5,3	2,1	5,2	2,03	75	1,5 (16)
CFW11 0010 S 2	11,1	4,4	10,83	4,22	36	2,5 (14)
CFW11 0010 T 2	7,1	2,9	6,96	2,71	56	1,5 (16)
CFW11 0013 T 2	11,1	4,4	8,54	2,62	36	2,5 (14)
CFW11 0016 T 2	14,8	5,9	14,44	5,63	27	4 (12)
CFW11 0024 T 2	26,7	10,7	19,15	5,5	15	6 (10)
CFW11 0028 T 2	26,7	10,7	18,21	4,97	15	6 (10)
CFW11 0033 T 2	26,7	10,7	16,71	4,19	15	6 (10)
CFW11 0045 T 2	44	17,6	33,29	10,1	9,1	10 (8)
CFW11 0054 T 2	48,8	19,5	32,17	8,49	8,2	10 (8)
CFW11 0070 T 2	48,8	19,5	26,13	5,6	8,2	6 (8)
CFW11 0086 T 2	93	37,2	90,67	35,3	4,3	35 (2)
CFW11 0105 T 2	111,1	44,4	90,87	29,7	3,6	35 (2)
CFW11 0003 T 4	3,6	2,9	3,54	2,76	220	1,5 (16)
CFW11 0005 T 4	5,3	4,3	5,2	4,05	150	1,5 (16)
CFW11 0007 T 4	5,3	4,3	5,2	4,05	150	1,5 (16)
CFW11 0010 T 4	8,8	7	8,57	6,68	91	2,5 (14)
CFW11 0013 T 4	10,7	8,5	10,4	8,11	75	2,5 (14)
CFW11 0017 T 4	12,9	10,3	12,58	9,81	62	2,5 (12)
CFW11 0024 T 4	17	13,6	16,59	12,9	47	4 (10)
CFW11 0031 T 4	26,7	21,3	20,49	12,6	30	6 (10)
CFW11 0038 T 4	36,4	29,1	26,06	14,9	22	6 (8)
CFW11 0045 T 4	47,1	37,6	40	27,2	17	10 (8)
CFW11 0058 T 4	53,3	42,7	31,71	15,1	15	10 (8)
CFW11 0070 T 4	66,7	53,3	42,87	22,1	12	10 (6)
CFW11 0088 T 4	87,9	70,3	63,08	36,2	9,1	25 (4)
CFW11 0142 T 2 O DB	266,7	106,7	142	30,2	1,5	70 (2/0) или 2x 25 (2x 4)
CFW11 0180 T 2 O DB	266,7	106,7	180	48,6	1,5	120 (4/0) или 2x 35 (2x 2)
CFW11 0211 T 2 O DB	333,3	133,3	211	53,4	1,2	150 (300) или 2x 50 (2x 1)
CFW11 0105 T 4 O DB	186	148,8	105	47,4	4,3	50 (1)
CFW11 0142 T 4 O DB	266,7	213,3	142	60,5	3	70 (2/0) или 2x 25 (2x 4)
CFW11 0180 T 4 O DB	266,7	213,3	180	97,2	3	120 (4/0) или 2x 35 (2x 2)
CFW11 0211 T 4 O DB	363,6	290,9	191,7	80,8	2,2	120 (250) или 2x 50 (2x 1)

Примечания

(1) Указанные значения эффективного тормозного тока являются ориентировочными, поскольку зависят от рабочих циклов торможения. Значение эффективного тормозного тока можно рассчитать по приведенной ниже формуле, где T_{торм} представляет собой значение в минутах, соответствующее сумме всех периодов торможения в течение самого нагруженного цикла длительностью 5 (пять) минут.

$$I_{\text{эффект}} = I_{\text{макс}} \cdot \sqrt{\frac{T_{\text{торм}}}{5}}$$

(2) Представленные значения P_{макс} и P_р (максимальная и средняя мощность тормозного резистора) являются действительными для рекомендуемых резисторов и приведенных в таблице значений эффективных тормозных токов. Мощность резистора должна изменяться в соответствии с рабочим циклом торможения.



Frequentie Regelaar

Installatiehandleiding

Serie: CFW-11

Taal: Nederlands

Document: 10001803811 / 00

Publicatiedatum: 01/2013

INHOUD

OVER DEZE HANDLEIDING.....	127
VEILIGHEIDSINSTRUCTIES.....	127
BESCHRIJVING VAN DE CFW-11	127
ONTVANGST EN OPSLAG.....	127
MECHANISCHE INSTALLATIE.....	127
ALGEMENE MONTAGEAANWIJZINGEN	127
MONTAGE IN EEN KAST	128
ELEKTRISCHE INSTALLATIE	130
AANSLUITSCHEMA'S	130
OPMERKINGEN OVER CIRCUITS EN APPARATEN.....	131
IT-NETWERKEN	132
AARDAANSLUITING	132
BESTURINGSAANSLUITINGEN	133
INSTALLATIE VOLGENS DE EUROPESE RICHTLIJN ELEKTROMAGNETISCHE COMPATIBILITEIT....	135
GEÏNTEGREERD BEDIENINGSPANEEL - HMI-CFW11	136
PARAMETERSTRUCTUUR.....	137
OPSTARTEN	137
VOORDAT DE OMFORMER IN WERKING WORDT GESTELD	137
OPSTARTEN IN V/F-MODUS	137
DATUM EN TIJD INSTELLEN.....	138
PARAMETERWIJZIGINGEN VOORKOMEN.....	138
FUNCTIES FLASHGEHEUGENMODULE	138
APPENDIX 1 – TECHNISCHE SPECIFICATIES	139

OVER DEZE HANDLEIDING

Deze handleiding bevat instructies voor het installeren van de frequentieomvormers van het type CFW-11 met framegrootte A t/m G en het opstarten in de V/f-modus.

Raadpleeg voor meer informatie de gebruikershandleiding en de programmeerhandleiding van de CFW-11.

De CFW-11 kan ook in de volgende besturingsmodi worden bediend: VVW, sensorloze vectorbesturing en vectorbesturing met encoder, voor inductiemotoren en sensorloze en encoder-vectorbesturing voor motoren met permanente magneet (PM). Raadpleeg de programmeerhandleiding.

Bezoek de website van WEG www.weg.net voor informatie over andere functies, accessoires en communicatie en het downloaden van de betreffende handleidingen.

VEILIGHEIDSINSTRUCTIES

Lees deze handleiding helemaal door voordat u de omvormer installeert en in gebruik neemt.

Alleen geschoold en gekwalificeerd personeel is bevoegd om deze apparatuur te installeren en op te starten en om storingen op te sporen en te verhelpen. Het personeel moet alle veiligheidsvoorschriften die in deze handleiding vermeld staan en/of worden voorgeschreven door de lokale regelgeving opvolgen.



GEVAAR!

Als de veiligheidsvoorschriften niet strict worden opgevolgd kan dit leiden tot zware of dodelijke verwondingen en/of materiële schade. Schakel altijd eerst de voeding uit voordat u een elektrische component van de omvormer aanraakt. Diverse componenten kunnen zelfs na het uitschakelen of loskoppelen van de voeding onder hoge spanning blijven staan en/of blijven draaien (ventilatoren). Wacht ten minste 10 minuten om ervoor te zorgen dat de condensatoren volledig ontladen zijn. Verbind het frame van het apparaat altijd met de aarde (PE).



OPMERKING!

Met gekwalificeerd personeel wordt in deze handleiding bedoeld personeel dat geschoold is in de volgende taken:

1. Het installeren, aarden, opstarten en bedienen van de CFW-11 volgens deze handleiding en de geldende wettelijke veiligheidsprocedures.
2. Het gebruiken van de veiligheidsvoorzieningen volgens de regelgeving.
3. Het verlenen van eerste hulp.



OPMERKING!

De frequentieomvormer kan interferentie met andere elektronische apparatuur veroorzaken. Volg de installatie-instructies om deze effecten tot een minimum te beperken.

BESCHRIJVING VAN DE CFW-11

De frequentieomvormer CFW-11 is een product met een groot prestatievermogen dat verkrijgbaar is met vermogens van 1 tot 600 pk (0,75 tot 450 kW) in zeven verschillende bouwgrootten en netspanningen van 200 V tot 480 V. De frequentieomvormer is ontworpen voor de regeling van het toerental en het koppel bij driefasige inductiemotoren en PM-motoren. Het belangrijkste kenmerk van dit product is de 'Vectrue'-technologie, met de volgende besturingsmodi: Scalaire besturing (V/f), VVW, 'sensorloze vectorbesturing' en 'vectorbesturing met encoder'. Andere opvallende functies en voorzieningen: 'Optimal Braking', 'Self-Tuning' en 'Optimal Flux'.

Raadpleeg voor meer informatie de gebruikershandleiding en de programmeerhandleiding van de CFW-11.

ONTVANGST EN OPSLAG

Controleer bij ontvangst van het product het volgende:

Controleer of de gegevens op het typeplaatje van de CFW-11 overeenkomen met die op uw bestelling. Raadpleeg de modellen en technische gegevens in de [tabellen A.1](#) en [A.2](#).

Controleer het product op eventuele transportschade. Neem bij schade onmiddellijk contact op met de transporteur.

Indien de CFW-11 niet direct wordt geïnstalleerd, sla het apparaat dan in de originele verpakking op in een schone en droge ruimte (opslagtemperatuur tussen -25 °C en 60 °C).

MECHANISCHE INSTALLATIE

OMGEVING

Vermijd het volgende:

- Directe blootstelling aan zonlicht, regen, hoge luchtvochtigheid of zeelucht.
- Blootstelling aan ontvlambare of bijtende gassen of vloeistoffen.
- Overmatige trillingen.
- Blootstelling aan stof, metaaldeeltjes en olienevel.
- Omgevingsomstandigheden volgens de [tabellen A.1](#) en [A.2](#).

ALGEMENE MONTAGEAANWIJZINGEN

Houd rekening met het gewicht van de omvormer in de [tabellen A.1](#) en [A.2](#).

Monteer de omvormer rechtop op een vlak en verticaal oppervlak.

Zie [afbeelding 1](#) voor de externe afmetingen en de positie van de montagegaten.

Zie [afbeelding 2](#) voor de vereiste minimale vrije ruimte rondom de omvormer voor een goede circulatie van de koellucht.

Opmerking:

- Voor de bouwgrootten A, B en C: montage naast elkaar - geen vrije ruimte vereist tussen de omvormers als de bovenste afdekking verwijderd is.

Monteer geen warmtegevoelige componenten direct boven de omvormer.

MONTAGE IN EEN KAST

Wandmontage:

Zorg voor voldoende uitlaatopeningen zodat de temperatuur in de kast binnen het toegestane bereik voor de bedrijfsomstandigheden van de omvormer blijft.

Het vermogensverlies van de omvormer en de nominale conditie is aangegeven in de **tabellen A.1** en **A.2** 'Vermogensverlies in watt - wandmontage'.

Zie **tabel 1** voor de minimale vereisten voor de koelluchtstroom van de kast.

Zie **afbeelding 1** voor de positie en de diameter van de montagegaten.

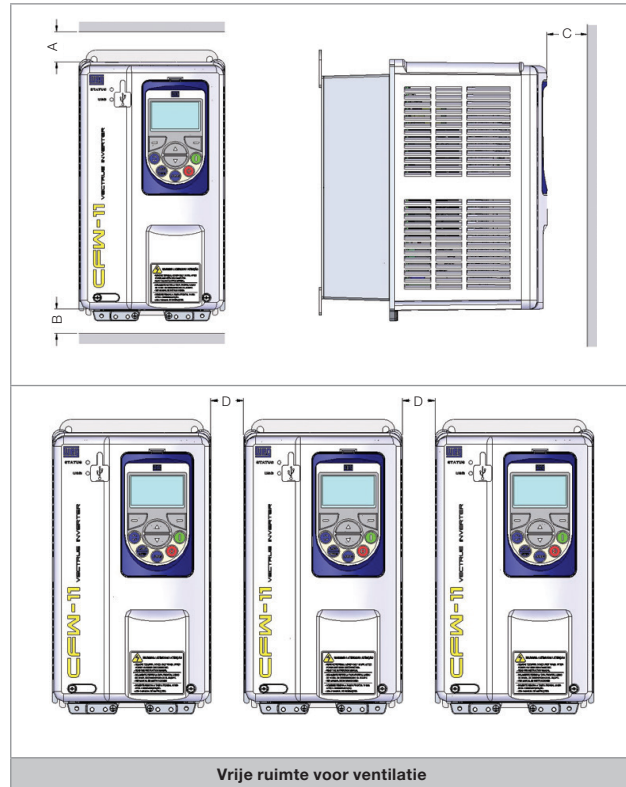
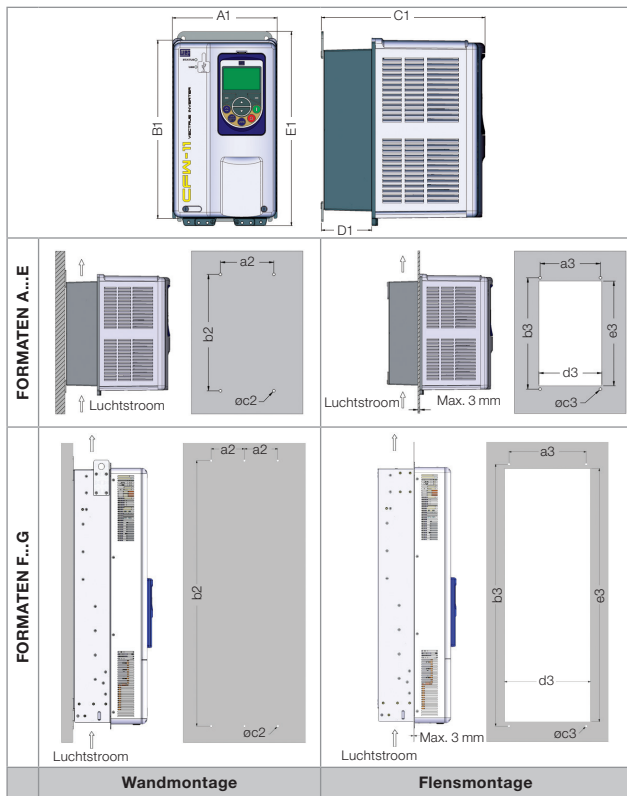

Model	A mm	B mm	C mm	D mm
Bouwgrootte A	25	25	10	30
Bouwgrootte B	40	45		
Bouwgrootte C	100	130		
Bouwgrootte D	100	130	20	40
Bouwgrootte E	0142 T2	130		
	0180 T2	250		
	0211 T2	250		
	0105 T4	130		
Bouwgrootte F	0142 T4	250		80
	0180 T4	250		
Bouwgrootte G	150	250		

Tolerantie: ±1,0 mm

Afbeelding 2: Minimale vrije ruimte voor de ventilatie van de omvormer

Tabel 1: Minimale vereisten voor de koelluchtstroom in de kast

Formato	Model	CFM	l/s	m³/min.
A	ALLE	18	8	0,5
B	ALLE	42	20	1,2
C	ALLE	96	45	2,7
D	ALLE	132	62	3,7
E	CFW11 0142 T 2	138	65	3,9
	CFW11 0180 T 2	265	125	7,5
	CFW11 0211 T 2			
	CFW11 0105 T 4	138	65	3,9
	CFW11 0142 T 4	180	95	5,1
	CFW11 0180 T 4	265	125	7,5
CFW11 0211 T 4				
F	CFW11 0242 T 4	250	118	7,1
	CFW11 0312 T 4	320	151	9,1
	CFW11 0370 T 4	380	180	10,1
	CFW11 0477 T 4	460	217	13
	CFW11 0515 T 4	680	321	19,3
CFW11 0601 T 4				
G	CFW11 0720 T 4			

Model	A1	B1	C1	D1	E1	a2	b2	c2	a3	b3	c3	d3	e3
	mm (inch)	mm (inch)	mm (inch)	mm (inch)	mm (inch)	mm (inch)	mm (inch)	M	mm (inch)	mm (inch)	M	mm (inch)	mm (inch)
Bouwgrootte A	145 (5.71)	247 (9.73)	227 (8.94)	70 (2.75)	270 (10.63)	115 (4.53)	250 (9.85)	M5	130 (5.12)	240 (9.45)	M5	135 (5.32)	225 (8.86)
Bouwgrootte B	190 (7.48)	293 (11.53)	227 (8.94)	71 (2.78)	316 (12.43)	150 (5.91)	300 (11.82)	M5	175 (6.89)	285 (11.23)	M5	179 (7.05)	271 (10.66)
Bouwgrootte C	220 (8.67)	378 (14.88)	293 (11.53)	136 (5.36)	405 (15.95)	150 (5.91)	375 (14.77)	M6	195 (7.68)	365 (14.38)	M6	205 (8.08)	345 (13.59)
Bouwgrootte D	300 (11.81)	504 (19.84)	305 (12.00)	135 (5.32)	550 (21.65)	200 (7.88)	525 (20.67)	M8	275 (10.83)	517 (20.36)	M8	285 (11.23)	485 (19.10)
Bouwgrootte E	335 (13.19)	620 (24.41)	358 (14.09)	168 (6.61)	675 (26.57)	200 (7.88)	650 (25.59)	M8	275 (10.83)	635 (25.00)	M8	315 (12.40)	615 (24.21)
Bouwgrootte F	430 (16.93)	1156 (45.51)	360 (14.17)	169 (6.65)	1234 (48.58)	150 (5.91)	1200 (47.24)	M10	350 (13.78)	1185 (46.65)	M10	391 (15.39)	1146 (45.12)
Bouwgrootte G	535 (21.06)	1190 (46.85)	426 (16.77)	202 (7.95)	1264 (49.76)	200 (7.87)	1225 (48.23)	M10	400 (15.75)	1220 (48.03)	M10	495 (19.49)	1182 (46.53)

Tolerantie voor d3 en e3: +1,0 mm

Algemene tolerantie: ±1,0 mm

Afbeelding 1: Gegevens mechanische installatie

Flensmontage:

De opgegeven verliezen in de [tabellen A.1 en A.2](#) 'Vermogensverlies in watt - flensmontage worden afgegeven in de kast. De resterende verliezen worden afgegeven via de achterkant.

De bevestigingssteunen en de takelogen van de omvormer moeten worden verwijderd en verplaatst, bij de bouwgrootten E, F en G. Zie [afbeeldingen 3 en 4](#).

Het gedeelte van de omvormer dat zich buiten de kast bevindt heeft beschermingsgraad IP54, voor bouwgrootten A t/m E. Voor bouwgrootten F en G heeft dit gedeelte beschermingsgraad IP20.

Zorg voor een geschikte pakking voor de kastopening om aan de beschermingsgraad van de kast te blijven voldoen. Voorbeeld: siliconenpakking.

Zie [afbeelding 1](#) voor de afmetingen van de uitsparingen in het montageoppervlak en de positie en de diameter van de montagegaten.

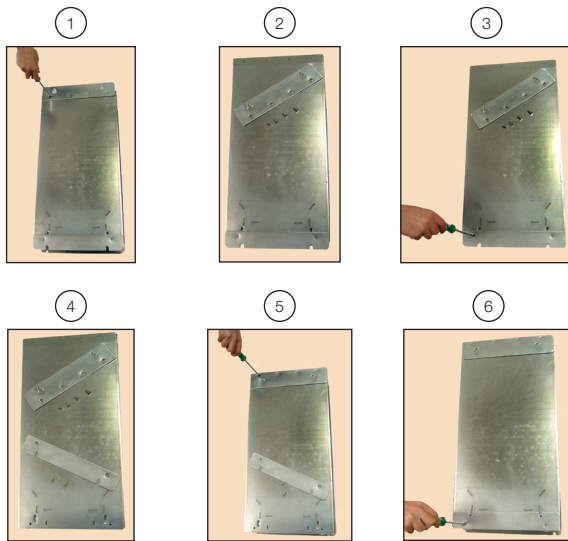

Afbeelding 3: Verplaatsing van de bevestigingssteunen voor de bouwgrootten A t/m E. Bij de bouwgrootten F en G moeten de bevestigingssteunen worden verwijderd

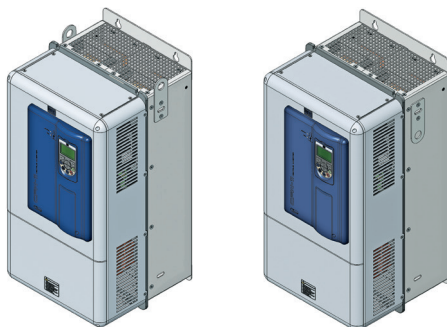

Afbeelding 4: Montage van de takelogen – bouwgrootten E, F en G

Toegang tot de besturings- en vermogensaansluitingen

Om de besturings- en vermogensaansluitingen te kunnen bereiken, moeten bij de bouwgrootten A t/m C de HMI en de afdekking worden verwijderd. Zie [afbeelding 5](#).

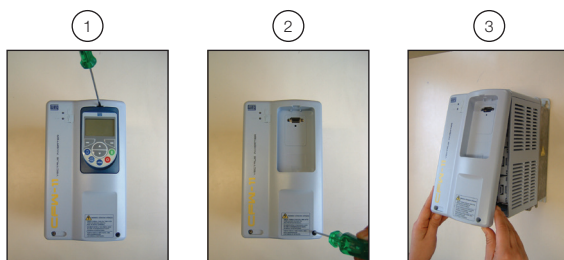

Afbeelding 5: Verwijdering van de HMI en de afdekking

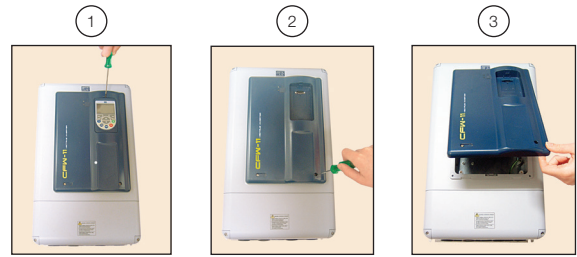

Afbeelding 6: Verwijdering van de HMI en de afdekking bij de bouwgrootten D, E, F en G voor toegang tot de besturingsaansluitingen

Om de vermogensaansluitingen te kunnen bereiken, moet bij de bouwgrootten D t/m G de onderste afdekking worden verwijderd zoals op [afbeelding 7](#) wordt getoond.

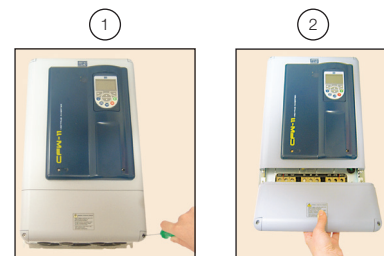

Afbeelding 7: Verwijdering van de onderste afdekking voor toegang tot de vermogensaansluitingen bij de bouwgrootten D t/m G

Als niet aan de beschermingsgraad IP20 of Nema1 hoeft te worden voldaan, kan de onderste kabeldoorvoerplaat worden verwijderd bij de bouwgrootten D en E.

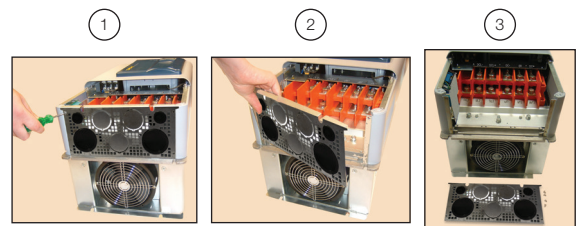

Afbeelding 8: Verwijdering van de kabeldoorvoerplaat

Verwijder bij de bouwgrootten F en G altijd de bodemplaat voor het aansluiten van de voedingskabels (net en motor), zoals te zien is op [afbeelding 9](#).

In dit geval neemt de beschermingsgraad van het onderste gedeelte van de omvormer af.

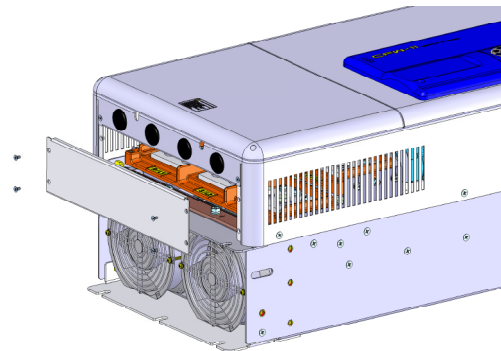

Afbeelding 9: Verwijdering van de kabeldoorvoerplaat bij de bouwgrootten F en G

ELEKTRISCHE INSTALLATIE



GEVAAR!

Zorg ervoor dat de voedingskabel uit het stopcontact is getrokken voordat de installatie wordt gestart.



GEVAAR!

De volgende informatie dient slechts als leidraad voor een juiste installatie. Houdt u aan de toepasselijke lokale regelgeving met betrekking tot elektrische installaties.



GEVAAR!

De omvormer raakt beschadigd als de ingangsvvoeding wordt aangesloten op de uitgangsklemmen.

AANSLUITSCHEMA'S

Opmerkingen:

Technische specificaties, waaronder hoofdzekeringen, staan in de tabellen A.1 en A.2.

Technische specificatie van remweerstand en remstromen staat in tabel A.3.

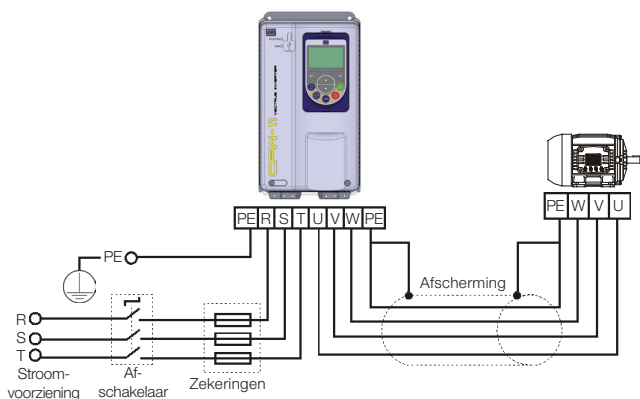

Afbeelding 10: Aansluitschema voor de standaardframes in de bouwgrootten A, B, C, D, E, F en G

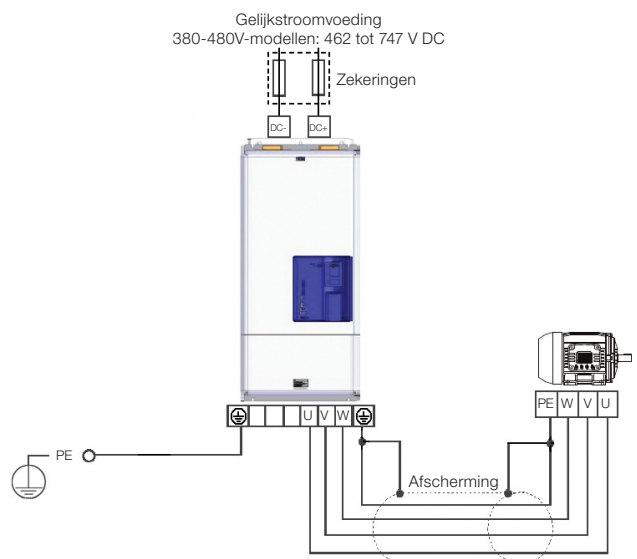

Afbeelding 11: Aansluitschema voor de voeding bij de bouwgrootten F en G met speciale gelijkstroomhardware

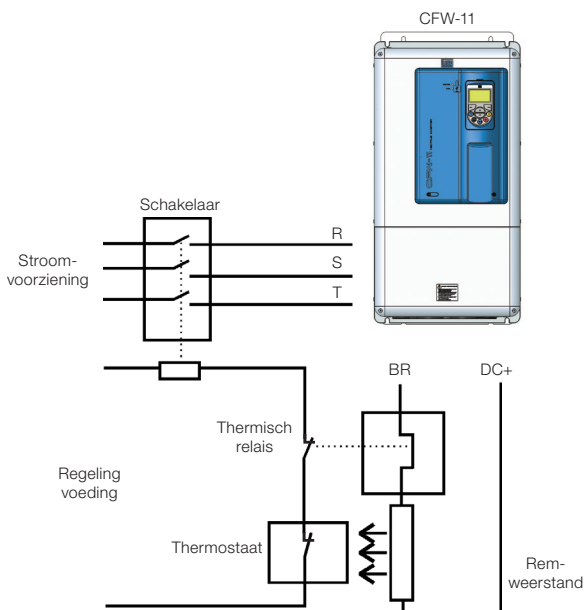

Afbeelding 12: Aansluitschema voor de remweerstand bij de bouwgrootten A, B, C, D en E

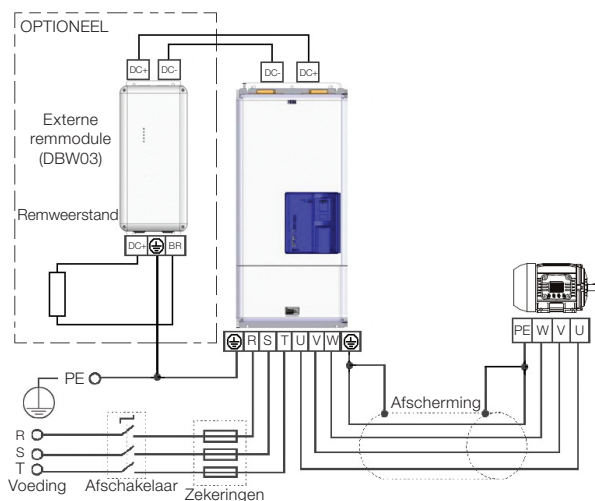

Afbeelding 13: Aansluitschema voor de voeding bij de bouwgrootten F en G standaard met remweerstand

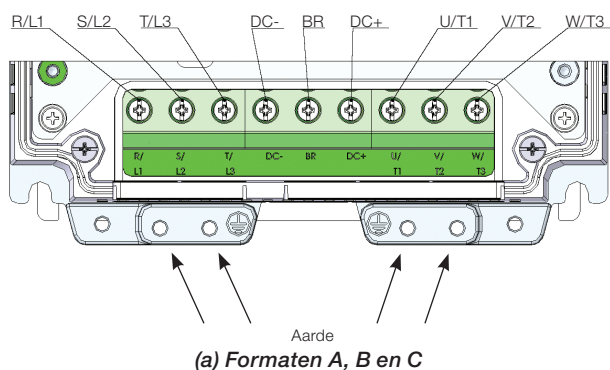

(a) Formaten A, B en C

Afbeelding 14 (a): Aansluitingen voor voeding en aarding bij de bouwgrootten A t/m C

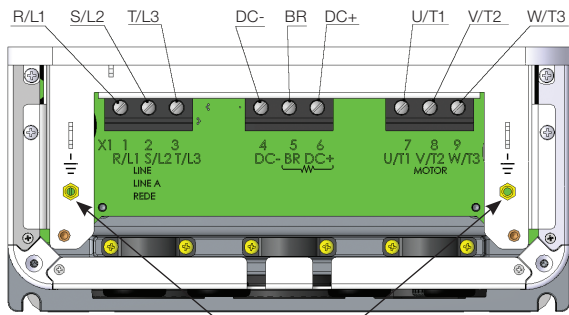

(b) Bouwgrootte D

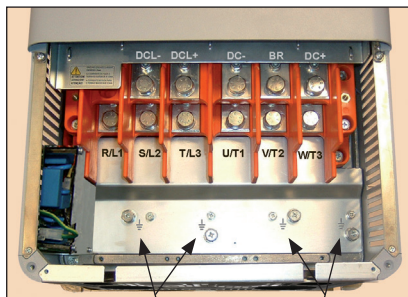

(c) Bouwgrootte E

Afbeelding 14 (b) en (c): Aansluitingen voor voeding en aarding bij de bouwgrootten D t/m E

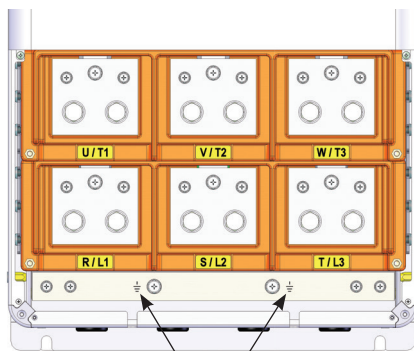

(a) Standaard

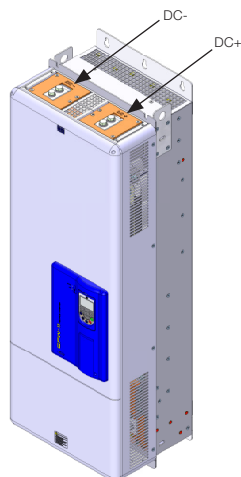

(b) Speciale DC-hardware

Afbeelding 15 (a) en (b): Aansluitingen voor voeding en aarding bij de bouwgrootten F en G

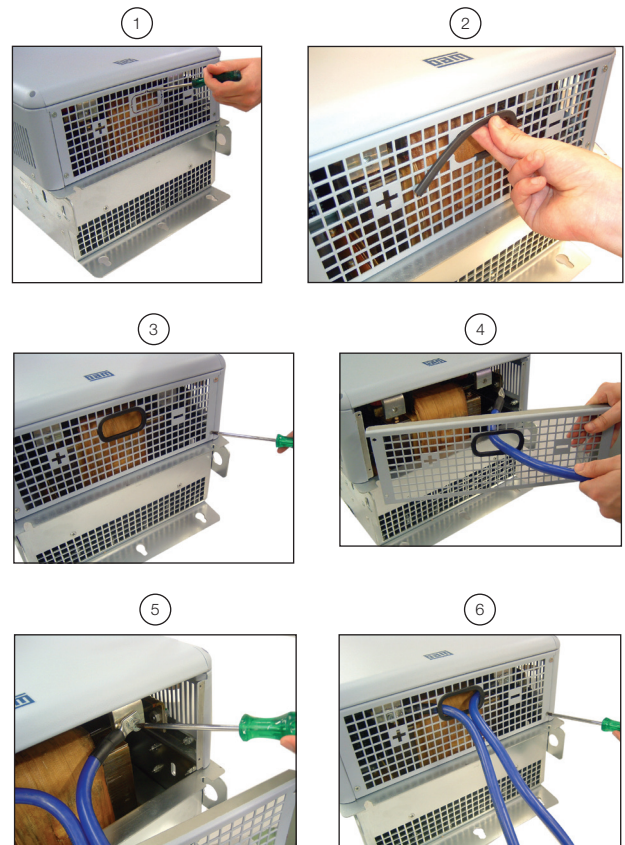

Afbeelding 16: Aansluiting van dynamische remmodule in de bouwgrootten F en G standaard

OPMERKINGEN OVER CIRCUITS EN APPARATEN

- De stroomvoorziening van de omvormer moet voorzien zijn van een geaard nulpunt. Voor IT-netwerken moet sommige interne componenten worden losgekoppeld zoals afgebeeld op afbeeldingen 17 t/m 19.
- Voorzie de stroomvoorziening van de omvormer van een afschakelaar. Hiermee kan de voeding van de omvormer zo nodig worden onderbroken (bijvoorbeeld tijdens onderhoud).
- Gebruik snelle zekeringen bij de ingang om de gelijkrichter van de omvormer en de bedrading te beschermen. Raadpleeg de tabellen A.1 en A.2 om de juiste zekeringsterkte te kiezen. I^2t moet gelijk zijn aan of minder zijn dan de waarde in de tabellen).
- Gebruik zekeringen van klasse J bij de voeding van de omvormer met een stroomwaarde die niet hoger is dan de waarden in de tabellen A.1 en A.2 om aan de UL-vereisten te voldoen.
- Naar eigen keuze kunnen trage zekeringen worden gebruikt bij de ingang. De zekeringsterkte moet 1,2 x de nominale ingangsstroom van de omvormer zijn. In dat geval is de installatie beveiligd tegen kortsluiting, maar niet de gelijkrichter aan de ingang van de omvormer. Bij een storing in een interne component kan de omvormer ernstig beschadigd raken.
- De omvormer CFW-11 is geschikt voor gebruik in stroomkringen die maximaal 100.000 A rms symmetrisch leveren (230 V / 480 V).
- Het gebruik van een afgeschermd motorkabel volgens IEC 60034-25 wordt aanbevolen.
- Houd motorkabels op ten minste 25 cm afstand van andere kabels zoals signaalkabels, sensorkabels, besturingskabels, enz.

IT-NETWERKEN

Als de nulleider niet geaard is of als voor de aarding een hoogohmse weerstand wordt gebruikt of in gearde driehoekschakelingen, moet de kabel met de ringaansluiting van de aardrail worden losgekoppeld en worden verbonden met het geïsoleerde punt van de vermogensaansluitingen, zoals op afbeelding wordt getoond.

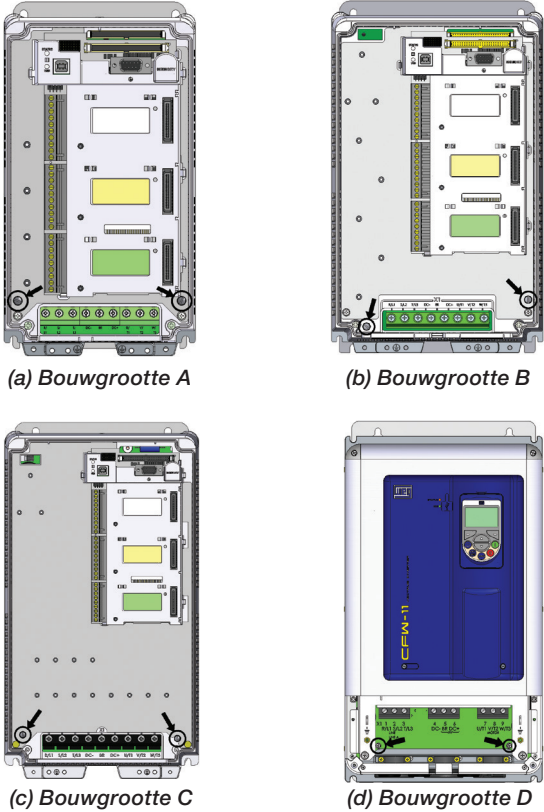

Afbeelding 17 (a) t/m (d): Formaten A t/m D - locatie van aardingsschroeven - verwijderen voor IT-netwerken

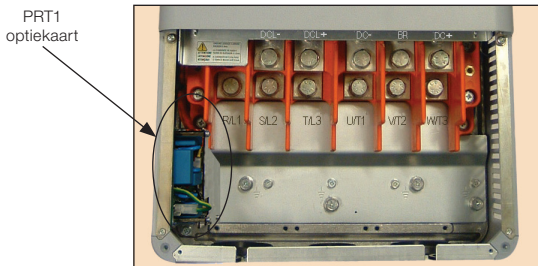

(a) Locatie van optiekaart

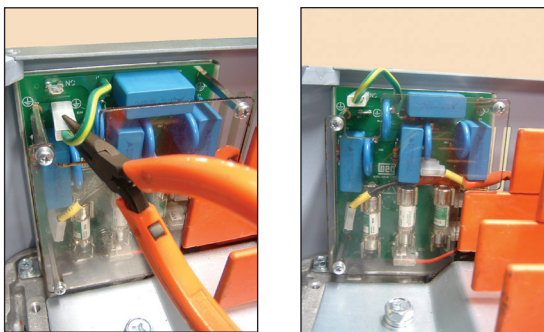

(b) Oorspronkelijke positie (c) Uiteindelijke positie (IT)

Afbeelding 18 (a) t/m (c): Bouwgrootte E - locatie van aansluiting op PRT1-optiekaart – positie wijzigen voor IT-netwerken

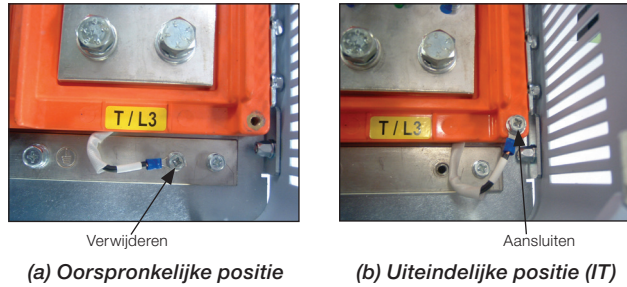

(a) Oorspronkelijke positie (b) Uiteindelijke positie (IT)

Afbeelding 19 (a) en (b): Formaten F en G - locatie van aansluiting op PRT1-optiekaart – positie wijzigen voor IT-netwerken

AARDAANSLUITING



GEVAAR!

De omvormer moet geaard zijn (PE). Raadpleeg de lokale regelgeving en/of elektrische codes voor het kiezen van de juiste dikte voor de aarddraad. Verbind de aardaansluitingen van de omvormer aan op een aardrail, op een apart aardingspunt, of op een gemeenschappelijk aardingspunt (impedantie $\leq 10 \Omega$). Om te voldoen aan de norm IEC 61800-5-1 moet de omvormer worden geaard met behulp van een eenaderige koperen kabel met een minimale draaddikte van 10 mm², aangezien de lekstroom hoger is dan 3,5 mA.



ATTENTIE!

De nulleider van de netvoeding moet degelijk geaard zijn. Deze draad mag echter niet worden gebruikt om de omvormer te aarden.

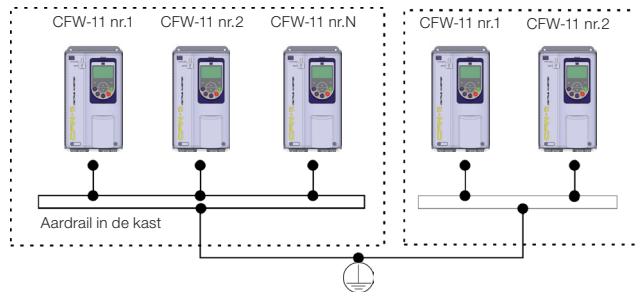

Afbeelding 20: Aardaansluitingen voor meerdere omvormers

BESTURINGSAANSLUITINGEN

De besturingsaansluitingen (analoge ingangen/uitgangen, digitale ingangen/uitgangen) moeten plaatsvinden op de klemlijst XC1 van paneel CC11.

	XC1 klemlijst	Standaardinstelling functie
	1	REF+
	2	AI1+
	3	AI1-
	4	REF-
	5	AI2+
	6	AI2-
	7	AO1
	8	AGND (24 V)
	9	AO2
	10	AGND (24 V)
	11	DGND*
	12	COM
	13	24 Vdc
	14	COM
	15	DI1
	16	DI2
	17	DI3
	18	DI4
	19	DI5
	20	DI6
	21	NC1
	22	C1
	23	NO1
	24	NC2
	25	C2
	26	NO2
	27	NC3
	28	C3
	29	NO3

Afbeelding 21: Signalen op connector XC1 - digitale ingangen werken als 'Active High'



OPMERKING!

Om naar 'Active Low' te wisselen, verplaatst u de draadbruggen tussen XC1:11 en 12, plaats u deze draadbruggen tussen XC1:12 en 13 en verbindt u de gemeenschappelijke punten van de schakelaars op DI1 t/m DI6 met XC1:11, in plaats van XC1:13.

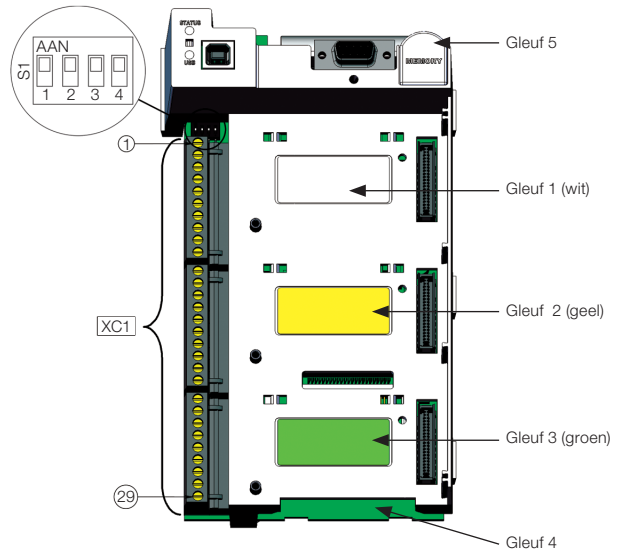

Signaal	Standaardfunctie af fabriek	DIP-switch	Keuze	Fabrieksinstelling
AI1	Toerentalreferentie (remote)	S1.4	UIT: 0 t/m 10 V (fabrieksinstelling) AAN: 4 t/m 20 mA / 0 t/m 20 mA	UIT
AI2	Geen functie	S1.3	UIT: 0 t/m ±10 V (fabrieksinstelling) AAN: 4 t/m 20 mA / 0 t/m 20 mA	UIT
AO1	Toerental	S1.1	UIT: 4 t/m 20 mA / 0 t/m 20 mA AAN: 0 t/m 10 V (fabrieksinstelling)	AAN
AO2	Motorstroom	S1.2	UIT: 4 t/m 20 mA / 0 t/m 20 mA AAN: 0 t/m 10 V (fabrieksinstelling)	AAN

Afbeelding 22: DIP-switches voor het instellen van het signaaltipe bij analoge ingangen en uitgangen



OPMERKING!

Raadpleeg de installatie-, configuratie en bedieningshandleiding voor informatie over de functie Veiligheidsstop (STO).

Typische besturingsaansluitingen

Besturingsaansluiting 1 - Start/Stop-functie bestuurd vanaf het bedieningspaneel (lokale modus).

Met deze besturingsaansluiting kan de omvormer in de lokale modus worden gestart met de standaard fabrieksinstellingen. Deze bewerkingsmodus is aanbevolen voor beginnende gebruikers, aangezien geen aanvullende besturingsaansluitingen vereist zijn.

Besturingsaansluiting 2 - 2-draads Start/Stop-functie (remote modus).

Dit bedradingsvoorbeeld geldt alleen voor de standaard fabrieksinstelling en als de omvormer in de remote modus is gezet. Met de standaard fabrieksinstellingen wordt de keuze van de bedieningsmodus (lokaal/remote) uitgevoerd via de HMI-toets (lokale modus is standaard). Met de instelling P0220=3 wijzigt u de standaardinstelling van de HMI-toets op de remote modus.

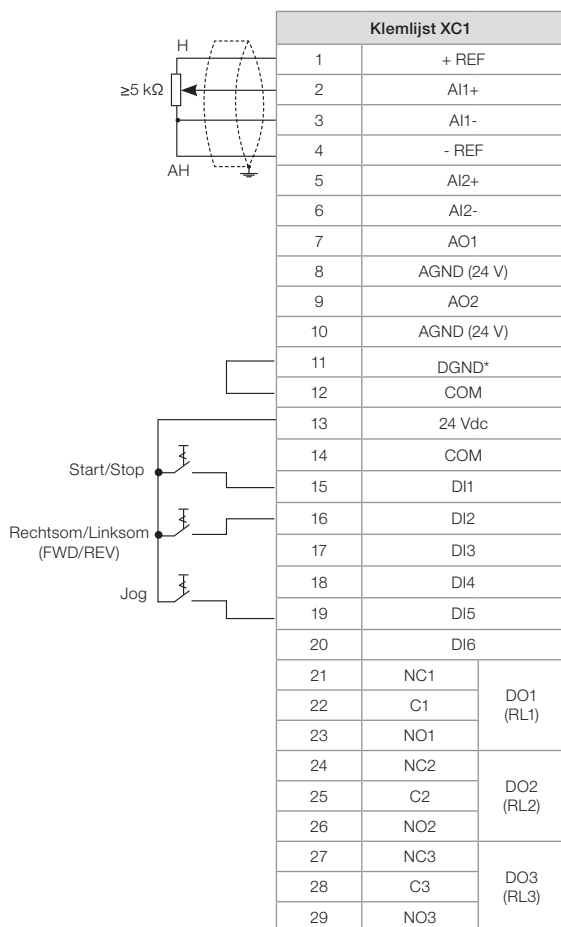

Afbeelding 23: XC1-bedrading voor besturingsaansluiting 2

Besturingsaansluiting 3 - 3-draads Start/Stop-functie.

Hiermee kan de Start/Stop-functie met 3-draads besturing worden uitgevoerd.

In te stellen parameters:

Stel DI3 op START in: P0265=6

Stel DI4 op STOP in: P0266=7

Stel P0224=1 (DIx) in voor 3-draads besturing in de lokale modus.

Stel P0227=1 (DIx) in voor 3-draads besturing in de remote modus. Stel de keuze Rechtsom/Linksom in door digitale ingang 2 (DI2) te gebruiken.

Stel P0223=4 in voor de lokale modus of P0226=4 voor de remote modus.

S1 en S2 zijn drukknoppen voor respectievelijk starten (arbeidscontact (NO)) en stoppen (rustcontact (NC)).

De toerentalreferentie is mogelijk via de analoge ingang (zoals bij besturingsaansluiting 2), via het bedieningspaneel (zoals bij besturingsaansluiting 1) of via een andere beschikbare bron.

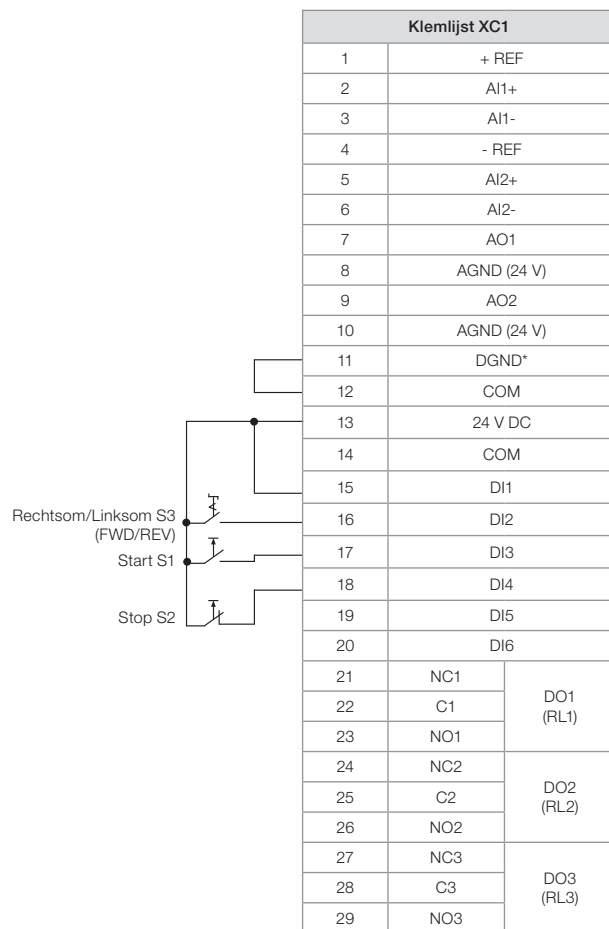

Afbeelding 24: XC1-bedrading voor besturingsaansluiting 3

Besturingsaansluiting 4 - Rechtsom/Linksom.

Hiermee kan de functie Rechtsom/Linksom worden uitgevoerd.

In te stellen parameters:

Stel DI3 op Rechtsom in: P0265=4

Stel DI4 op Linksom in: P0266=5

Als de functie Rechtsom/Linksom is ingesteld, wordt deze functie actief in de lokale of remote modus. De HMI-toetsen **O** en **I** blijven altijd inactief (zelfs als P0224=0 of P0227=0).

De draairichting wordt bepaald door de ingangen Rechtsom en Linksom.

Met de wijzers van de klok mee is Rechtsom, tegen de wijzers van de klok in is Linksom.

De toerentalreferentie is mogelijk via elke willekeurige bron (zoals bij besturingsaansluiting 3).

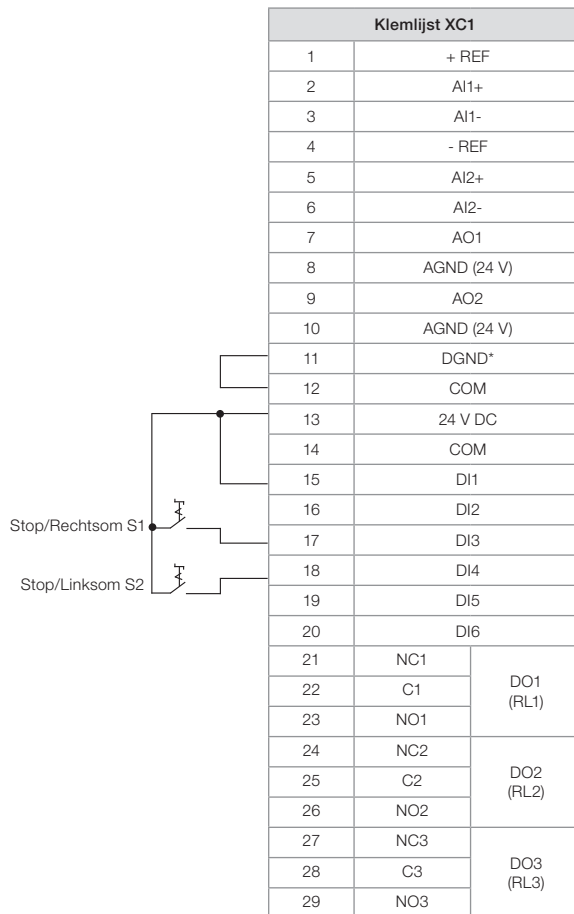

Afbeelding 25: XC1-bedrading voor besturingsaansluiting 4

INSTALLATIE VOLGENS DE EUROPESE RICHTLIJN ELEKTROMAGNETISCHE COMPATIBILITEIT

De omvormers in de bouwgrootten A t/m D met FA-optie (CFW11XXXXXXOFA) en alle standaard omvormers in de andere bouwgrootten beschikken over een intern RFI-filter voor de beperking van elektromagnetische interferentie. Deze omvormers voldoen, mits correct geïnstalleerd, aan de eisen van de Europese richtlijn inzake elektromagnetische compatibiliteit (EMC-richtlijn 2004/108/EG).

ATTENTIE!

Volg de instructies in de [afbeeldingen 17 t/m 19](#) voor het gebruik van modellen met interne RFI-filters in IT-netwerken.

Installatie volgens de voorschriften

Maak voor de installatie volgens de voorschriften gebruik van de volgende onderdelen:

1. Omvormers in de bouwgrootten A t/m D: met interne RFI-filters optie CFW11XXXXXXOFA en andere standaardmodellen.
2. Afgeschermdde uitgangskabels (motorkabels); sluit de afscherming aan beide kanten (motor en omvormer) met een lage impedantie aan voor een hoge frequentie. Maximumlengte van de motorkabels en emissieniveaus via geleiding en uitstraling volgens de [tabellen 2 en 3](#). Als een lager emissieniveau en/of een langere motorkabel noodzakelijk zijn, moet een extern RFI-filter worden toegepast bij de ingang van de omvormer. Raadpleeg de [tabellen 2 en 3](#) voor meer informatie (RFI-filters, motorkabellengte en emissieniveaus).
3. Afgeschermdde besturingskabels.
4. Degelijk geaarde omvormer.

Tabel 2: Emissieniveaus via geleiding en uitstraling voor bouwgrootten A t/m D

Omvormermodel (met ingebouwd RFI-filter)	Zonder extern RFI-filter			Met extern RFI-filter					
	Emissie via geleiding - maximumlengte motorkabel		Emissie via uitstraling	Externe RFI-filter onderdeelnr. (fabrikant: EPCOS)	Emissie via geleiding - maximumlengte motorkabel		Emissie via uitstraling - categorie	Zonder metalen kast	In een metalen kast
	Categorie C3	Categorie C2			Categorie C2	Categorie C2			
CFW11 0006 S 2 O FA	100 m	7 m	C2	B84142-A16-R122	75 m	50 m	C2	C2	
				B84142-B16-R	100 m	100 m			
CFW11 0007 T 2 O FA	100 m	5 m	C2	B84143-G8-R110	100 m	-	C2	C2	
				B84143-A8-R105	50 m	50 m			
CFW11 0007 S 2 O FA	100 m	7 m	C2	B84142-A16-R122	75 m	50 m	C2	C2	
				B84142-B16-R	100 m	100 m			
CFW11 0010 S 2 O FA	100 m	7 m	C2	B84142-A30-R122	75 m	50 m	C2	C2	
				B84142-B25-R	100 m	100 m			
CFW11 0010 T 2 O FA	100 m	5 m	C2	B84143-G20-R110	100 m	-	C2	C2	
				B84143-A16-R105	50 m	50 m			
CFW11 0013 T 2 O FA	100 m	5 m	C2	B84143-G20-R110	100 m	-	C2	C2	
				B84143-A16-R105	50 m	50 m			
CFW11 0016 T 2 O FA	100 m	5 m	C2	B84143-G20-R110	100 m	-	C2	C2	
				B84143-A25-R105	50 m	50 m			
CFW11 0024 T 2 O FA	100 m	Geen	C2	B84143-A36-R105	100 m	100 m	C2	C2	
CFW11 0028 T 2 O FA	100 m	Geen	C2	B84143-A36-R105	100 m	100 m	C2	C2	
CFW11 0033 T 2 O FA	100 m	Geen	C2	B84143-A50-R105	100 m	100 m	C2	C2	
CFW11 0045 T 2 O FA	100 m	Geen	C3	B84143-A50-R105	100 m	100 m	C3	C2	
CFW11 0054 T 2 O FA	100 m	Geen	C3	B84143-A66-R105	100 m	100 m	C3	C2	
CFW11 0070 T 2 O FA	100 m	Geen	C3	B84143-A90-R105	100 m	100 m	C3	C2	
CFW11 0086 T 2 O FA	100 m	Geen	C3	B84143-A120-R105	100 m	100 m	C3	C2	
CFW11 0105 T 2 O FA	100 m	Geen	C3	B84143-A120-R105	100 m	100 m	C3	C2	
				B84143-G8-R110	100 m	-			
CFW11 0003 T 4 O FA	100 m	5 m (16,40 ft)	C2	B84143-G8-R110	100 m	-	C2	C2	
				B84143-A8-R105	50 m	50 m			
CFW11 0005 T 4 O FA	100 m	5 m (16,40 ft)	C2	B84143-G8-R110	100 m	-	C2	C2	
				B84143-A8-R105	50 m	50 m			
CFW11 0007 T 4 O FA	100 m	5 m (16,40 ft)	C2	B84143-G8-R110	100 m	-	C2	C2	
				B84143-A8-R105	50 m	50 m			
CFW11 0010 T 4 O FA	100 m	5 m (16,40 ft)	C2	B84143-G20-R110	100 m	-	C2	C2	
				B84143-A16-R105	50 m	50 m			
CFW11 0013 T 4 O FA	100 m	5 m (16,40 ft)	C2	B84143-G20-R110	100 m	-	C2	C2	
				B84143-A16-R105	50 m	50 m			
CFW11 0017 T 4 O FA	100 m	Geen	C2	B84143-A25-R105	100 m	100 m	C2	C2	
CFW11 0024 T 4 O FA	100 m	Geen	C2	B84143-A36-R105	100 m	100 m	C2	C2	
CFW11 0031 T 4 O FA	100 m	Geen	C2	B84143-A36-R105	100 m	100 m	C2	C2	
CFW11 0038 T 4 O FA	100 m	Geen	C3	B84143-A50-R105	100 m	100 m	C3	C2	
CFW11 0045 T 4 O FA	100 m	Geen	C3	B84143-A50-R105	100 m	100 m	C3	C2	
CFW11 0058 T 4 O FA	100 m	Geen	C3	B84143-A66-R105	100 m	100 m	C3	C2	
CFW11 0070 T 4 O FA	100 m	Geen	C3	B84143-A90-R105	100 m	100 m	C3	C2	
CFW11 0088 T 4 O FA	100 m	Geen	C3	B84143-A120-R105	100 m	100 m	C3	C2	

Tabel 3: Emissieniveaus via geleiding en uitstraling voor bouwgrootten E t/m G

Omvormermodel (ingebouwd RFI-filter)	Zonder extern RFI-filter		Met extern RFI-filter		
	Emissie via geleiding - maximumlengte motorkabel	Emissie via uitstraling	Extern RFI-filter onderdeelnr. - (fabrikant: EPCOS)	Emissie via geleiding - maximumlengte motorkabel	Emissie via uitstraling - zonder metalen kast
CFW11 0142 T2	100 m	C2	B84143-B0150-S020	100 m	C2
CFW11 0180 T2	100 m	C2	B84143-B0180-S020 (1)	100 m	C2
CFW11 0211 T2	100 m	C2	B84143-B0250-S020 (2)	100 m	C2
CFW11 0105 T4	100 m	C2	B84143-B0150-S020	100 m	C2
CFW11 0142 T4	100 m	C2	B84143-B0150-S020	100 m	C2
CFW11 0180 T4	100 m	C2	B84143-B0180-S020 (1)	100 m	C2
CFW11 0211 T4	100 m	C2	B84143-B0250-S020 (2)	100 m	C2
CFW11 0242 T4	100 m	C3 (3)	B84143-B0250-S021	100 m (4)	C3
CFW11 0312 T4	100 m	C3 (3)	B84143-B01420-S021	100 m (4)	C3
CFW11 0370 T4	100 m	C3 (3)	B84143-B0400-S021	100 m (4)	C3
CFW11 0477 T4	100 m	C3 (3)	B84143-B0600-S021	100 m (4)	C3
CFW11 0515 T4	100 m	C3 (3)	B84143-B0600-S021	100 m (4)	C3
CFW11 0601 T4	100 m	C3 (3)	B84143-B0600-S021	100 m (4)	C3
CFW11 0720 T4	100 m	C3 (3)	B84143-B1000-S021	100 m (4)	C3

Opmerkingen over tabel 3:

- (1) Voor omgevingstemperaturen hoger dan 40 °C en een continue uitgangsstroom hoger dan 172 A rms, moet het filter B84143B0250S020 worden gebruikt.
- (2) Voor een omgevingstemperatuur van 40 °C en HD-toepassingen (heavy duty cyclus, uitgangsstroom < 180 A rms), kan het filter B84143B0180S020 worden gebruikt.
- (3) Met een torusvormige kern in de drie voedingskabels. Voorbeeld: TDK ond.nr.: PC40U120x160x20.
- (4) Minimale bedrijfsfrequentie 2,5 Hz.

GEÏNTEGREERD BEDIENINGSPANEEL - HMI-CFW11

Linkersoftkey: functie gedefinieerd door de tekst direct boven de softkey op het display.

Rechtsersoftkey: functie gedefinieerd door de tekst direct boven de softkey op het display.

- Hiermee verhoogt u de waarde van de parameter.
- Hiermee verhoogt u het toerental.
- Hiermee selecteert u de vorige groep uit de lijst met parametergroepen.

- Hiermee verlaagt u de waarde van de parameter.
- Hiermee verlaagt u het toerental.
- Hiermee selecteert u de volgende groep uit de lijst met parametergroepen.

Hiermee regelt u de draairichting van de motor. Actief als: P0223=2 of 3 in LOC en/of P0226=2 of 3 in REM.

Hiermee verhoogt u het motortoerental volgens deacceleratiecurve. Actief als: P0224=0 in LOC en/of P0227=0 in REM.

Hiermee kiest u tussen LOCAL (lokaal) of REMOTE (remote of extern). Actief als: P0220=2 of 3.

Hiermee neemt het motortoerental volgens de deceleratiecurve af tot stilstand. Actief als: P0224=0 in LOC en/of P0227=0 in REM.

Hiermee verhoogt u het motortoerental volgens de acceleratiecurve tot aan het toerental dat is gedefinieerd in P0122. Dit motortoerental blijft gehandhaafd zolang u de toets ingedrukt houdt. Zodra u de toets loslaat, neemt het motortoerental volgens de deceleratiecurve af tot stilstand. Actief als aan alle onderstaande voorwaarden is voldaan:

- Start/Stop=Stop;
- Algemeen inschakelen=actief;
- P0225=1 in LOC en/of P0228=1 in REM.

Afbeelding 26: Toetsen van het bedieningspaneel en hun functies

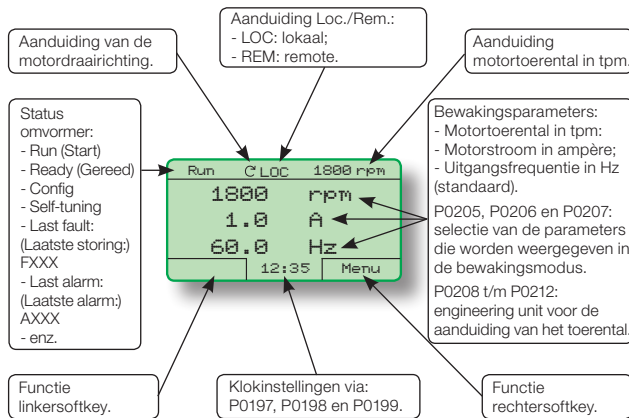

Afbeelding 27: Display van het bedieningspaneel en voorbeeld van standaardfuncties af fabriek (bewakingsmodus)



Afbeelding 28: Batterijdeksel op het bedieningspaneel

Opmerkingen over het bedieningspaneel:

- Hot pluggable.
- Andere bewakingssschermtypes, zoals staafgrafieken en grotere lettertypes, kunnen worden geprogrammeerd door P0205-207, P0208-212 aan te passen.
- De batterij wordt alleen gebruikt voor de interne klok als de omvormer langdurig van de voeding is losgekoppeld. Als de batterij leeg is of als geen batterij in het toetenbord is geplaatst, is de weergegeven tijd niet geldig en wordt bij het inschakelen van de omvormer telkens de alarmtoestand ,A181 - Invalid clock time' (A181 - Ongeldige tijd) weergegeven.
- Werp lege batterijen niet bij het huisvuil, maar lever ze in bij een inzamelpunt.

PARAMETERSTRUCTUUR

Als op de rechtersoftkey ('MENU') wordt gedrukt in de bewakingsmodus, verschijnt de eerste groep parameters op het display. Het nummer en de naam van de groepen kunnen verschillen, afhankelijk van de gebruikte firmwareversie.

OPSTARTEN

GEVAAR!
De omvormer raakt beschadigd als de ingangsvoeding wordt aangesloten op de uitgangsklemmen.

VOORDAT DE OMFORMER IN WERKING WORDT GESTELD

- 1) Controleer of de voedings-, aardings- en besturingskabels correct en stevig aangesloten zijn.
- 2) Verwijder al het materiaal dat na de installatie is achtergebleven uit de kast van de omvormer.
- 3) Controleer of de motoraansluitingen en de spanning en stroom binnen de nominale waarden van de omvormer vallen.
- 4) Ontlast de motor mechanisch. Als de motor niet kan worden ontkoppeld, zorg er dan voor dat elke draairichting (rechtsom of linksom) niet kan leiden tot persoonlijk letsel en/of schade aan de apparatuur.
- 5) Sluit de afdekkingen van de omvormer of de kast.
- 6) Meet de voedingsspanning en controleer of deze binnen het toegestane bereik valt.
- 7) Schakel de stroomvoorziening naar de ingang in door de afschakelaar te sluiten.
- 8) Controleer het resultaat van de eerste inschakeling: op het bedieningspaneel moet de standaardbewakingsmodus te zien zijn en de statusled moet continu groen branden.

OPSTARTEN IN V/F-MODUS

De opstartprocedure voor de V/f-modus wordt beschreven in drie eenvoudige stappen met behulp van de routine **Oriented Start-up** (Opstartassistent) en de groep **Basic Application** (Basistoepassing).

1) P0000 wachtwoordinstelling

Step	Actie/resultaat	Displayweergave
1	- Bewakingsmodus. - Druk op 'Menu' (rechtersoftkey).	Ready C LOC Brpm 0 rpm 0.0 A 0.0 Hz 15:45 Menu
2	- De groep '00 ALL PARAMETERS' (00 ALLE PARAMETERS) is al geselecteerd. - Druk op 'Select'.	Ready C LOC Brpm 00 ALL PARAMETERS 01 PARAMETER GROUPS 02 ORIENTED START-UP 03 CHANGED PARAMETERS Return 15:45 Select
3	- De parameter 'Access to Parameters P0000: 0' (Toegang tot parameters P0000: 0) is al geselecteerd. - Druk op 'Select'.	Ready C LOC Brpm Access to Parameters P0000: 0 Speed Reference P0001: 90 rpm Return 15:45 Select
4	- Druk op tot nummer 5 op het display verschijnt, om het wachtwoord in te stellen.	Ready C LOC Brpm P0000 Access to Parameters 0 Return 15:45 Save
5	- Druk op 'Save' (Opslaan) zodra het nummer 5 verschijnt.	Ready C LOC Brpm P0000 Access to Parameters 5 Return 15:45 Save
6	- Als de instelling correct is uitgevoerd, verschijnt op het display 'Access to Parameters P0000: 5' (Toegang tot parameters P0000: 5). - Druk op 'Return' (linkersoftkey).	Ready C LOC Brpm Access to Parameters P0000: 5 Speed Reference P0001: 90 rpm Return 15:45 Select
7	- Druk op 'Return'.	Ready C LOC Brpm 00 ALL PARAMETERS 01 PARAMETER GROUPS 02 ORIENTED START-UP 03 CHANGED PARAMETERS Return 15:45 Select
8	- Het display keert terug naar de bewakingsmodus.	Ready C LOC Brpm 0 rpm 0.0 A 0.0 Hz 15:45 Menu

Afbeelding 29: Stappen voor het wijzigen van de parameters via P0000

2) Opstartassistent

Een groep parameters met de naam 'Oriented Start-up' ('Opstartassistent') maakt het instellen van de omvormer gemakkelijker. Met parameter P0317 uit deze groep opent u de routine Opstartassistent.

De routine Opstartassistent toont de belangrijkste parameters op de HMI in een logische volgorde. De minimaal noodzakelijke parameters voor een goede werking worden aangepast. Informatie zoals de voedingsspanning en de gegevens van het motortypeplaatje worden ingevoerd.

U opent de routine Opstartassistent als volgt: stel eerst parameter P0317 op 1 in en stel vervolgens alle andere parameters die op het display verschijnen in.

Door het instellen van de parameters in de routine Opstartassistent worden de andere parameters en/of interne variabelen van de omvormer automatisch aangepast.

Tijdens de routine Opstartassistent wordt de melding 'Config' weergegeven in de linkerbovenhoek van het HMI-display.

3) Parameterinstellingen basistoepassing

Na het uitvoeren van de routine Opstartassistent en het correct instellen van de parameters is de omvormer gereed voor werking in de V/f-modus.

De groep Basic Application (Basistoepassing) bevat de algemenere toepassingsparameters.

DATUM EN TIJD INSTELLEN

Open de groep HMI en wijzig: dag (P0194), maand (P0195) en jaar (P0196); tijd: uren (P0197), minuten (P0198) en seconden (P0199).

PARAMETERWIJZIGINGEN VOORKOMEN

Om onbevoegde of onbedoelde parameterwijzigingen te voorkomen, kan parameter P0000 worden ingesteld op een andere waarde dan 5.

FUNCTIES FLASHGEHEUGENMODULE

- U kunt een kopie van de omvormerparameters opslaan.
- U kunt parameters die zijn opgeslagen in het FLASH-geheugen naar de omvormer kopiëren.
- U kunt firmware die is opgeslagen in het FLASH-geheugen naar de omvormer kopiëren.
- U kunt het programma dat is gemaakt met SoftPLC opslaan.

Bij het inschakelen van de omvormer wordt dit programma (SoftPLC) naar het RAM-geheugen op het besturingspaneel van de omvormer gekopieerd en uitgevoerd.

Raadpleeg de programmeerhandleiding van de CFW-11 en de handleiding van SoftPLC voor meer informatie.

APPENDIX 1 – TECHNISCHE SPECIFICATIES
Tabel A.1: Technische specificaties van de bouwgrootten A t/m D

Model	Frame	Aantal stroomfasen	Gebruik bij Normal Duty-cyclus (ND)							Gebruik bij Heavy Duty-cyclus (HD)							Zekering [A] volgens de Europese IEC-norm	Zekering I ² t [A ² s] bij 25 °C	Omgevingstemperatuur [°C]	Dynamisch remmen	Beschikbaarheid van optiesets die in het product kunnen worden geïmplementeerd							
			Nominale uitgangsstroom [A rms]	Overbelastingstroom [A rms]		Nominale draagfrequentie [kHz]	Maximaal motorvermogen [pk/kW]	Nominale ingangsstroom [A rms]	Vermogensverlies [W]		Nominale uitgangsstroom [A rms]	Overbelastingstroom [A rms]		Maximaal motorvermogen [pk/kW]	Nominale draagfrequentie [kHz]	Nominale ingangsstroom [A rms]						Vermogensverlies [W]		Gewicht [kg]				
1 min	3 s	Wandmontage		Flensmontage	1 min				3 s	Wandmontage		Flensmontage	1 min				3 s	Wandmontage	Flensmontage									
CFW11 0006 B 2	A	1ø/3ø	6	6,6	9	5	1,5/1,1	12,3/6	130	25	5	7,5	10	5	1,5/1,1	10,3/5	120	25	5,7	15	420	Ingebouwd	Ja	Ja	Nema 1 (leidingset voor frame A)	Ingebouwd	Ja	Ja
CFW11 0006 S 2 O FA		1ø	6	6,6	9	5	1,5/1,1	12,3	130	25	5	7,5	10	5	1,5/1,1	10,3	120	25	5,7	15	420							
CFW11 0007 T 2		3ø	7	7,7	10,5	5	2/1,5	7	140	25	5,5	8,25	11	5	1,5/1,1	5,5	120	25	5,7	15	420							
CFW11 0007 B 2		1ø/3ø	7	7,7	10,5	5	2/1,5	14,4/7	140	25	7	10,5	14	5	2/1,5	14,4/7	140	25	6,1	20(1ø)/15(3ø)	420							
CFW11 0007 S 2 O FA		1ø	7	7,7	10,5	5	2/1,5	14,4	140	25	7	10,5	14	5	2/1,5	14,4	140	25	6,1	15	420							
CFW11 0010 T 2		3ø	10	11	15	5	3/2,2	10	170	30	8	12	16	5	2/1,5	8	170	30	5,7	15	420							
CFW11 0010 S 2		1ø	10	11	15	5	3/2,2	20,5	180	30	10	15	20	5	3/2,2	20,5	140	25	6,1	25	1000							
CFW11 0013 T 2		3ø	13	14,3	19,5	5	4/3,0	13	200	30	11	16,5	22	5	3/2,2	11	170	30	6,1	20	420							
CFW11 0016 T 2	3ø	16	17,6	24	5	5/3,7	16	230	30	13	19,5	26	5	4/3,0	13	190	30	6,3	25	420								
CFW11 0024 T 2	3ø	24	26,4	36	5	7,5/5,5	24	310	50	20	30	40	5	6,4/5	20	250	40	9,1	25	1000								
CFW11 0028 T 2	3ø	28	30,8	42	5	10	28	370	60	24	36	48	5	10,7/5	28	290	40	9,1	35	1000								
CFW11 0033 T 2	3ø	33,5	36,9	50,3	5	12,5/9,2	33,5	430	60	28	42	56	5	10,7/5	28	350	50	9,1	30	1000								
CFW11 0045 T 2	3ø	45	49,5	67,5	5	15/11	45	590	90	36	54	72	5	12,5/9,2	36	450	70	15,6	50	2750								
CFW11 0054 T 2	3ø	54	59,4	81	5	20/15	54	680	100	45	67,5	90	5	15/11	45	540	80	16,0	70	2750								
CFW11 0070 T 2	3ø	70	77	105	5	25/18,5	70	900	140	56	84	112	5	20/15	56	680	100	17,9	80	2750								
CFW11 0086 T 2	3ø	86	94,6	129	5	30/22	86	970	150	70	105	140	5	25/18,5	70	740	110	29,5	100	3150								
CFW11 0105 T 2	3ø	105	116	158	5	40/30	105	1200	180	86	129	172	5	30/22	86	920	140	31,4	125	3150								
CFW11 0003 T 4	B	3ø	3,6	3,96	5,40	5	2/1,5	3,6	130	25	3,6	5,4	7,2	5	2/1,5	3,6	110	25	5,7	15	190	Ingebouwd	Ja	Ja	Nema 1 (leidingset voor frame B)	Ingebouwd	Ja	Ja
CFW11 0005 T 4		3ø	5	5,5	7,5	5	3/2,2	5	140	25	5	7,5	10	5	3/2,2	5	140	25	5,9	15	190							
CFW11 0007 T 4		3ø	7	7,7	10,5	5	4/3	7	180	30	5,5	8,25	11	5	3/2,2	5,5	140	25	5,9	15	190							
CFW11 0010 T 4		3ø	10	11	15	5	6,4/5	10	220	30	10	15	20	5	6,4/5	10	200	30	6,1	15	495							
CFW11 0013 T 4		3ø	13,5	14,9	20,3	5	7,5/5,5	13,5	280	40	11	16,5	22	5	6,4/5	11	220	30	6,3	20	495							
CFW11 0017 T 4		3ø	17	18,7	25,5	5	10,7/5	17	360	50	13,5	20,3	27	5	7,5/5,5	13,5	270	40	9,1	25	495							
CFW11 0024 T 4		3ø	24	26,4	36	5	15/11	24	490	70	19	28,5	38	5	10,7/5	19	360	50	9,7	35	500							
CFW11 0031 T 4		3ø	31	34,1	46,5	5	20/15	31	560	80	25	37,5	50	5	15/11	25	430	60	10,4	35	1250							
CFW11 0038 T 4	3ø	38	41,8	57	5	25/18,5	38	710	110	33	49,5	66	5	20/15	33	590	90	16,4	50	1250								
CFW11 0045 T 4	3ø	45	49,5	67,5	5	30/22	45	810	120	38	57	76	5	25/18,5	38	650	100	19,6	50	2100								
CFW11 0058 T 4	3ø	58,5	64,4	87,8	5	40/30	58,5	1050	160	47	70,5	94	5	30/22	47	800	120	20,5	70	2100								
CFW11 0070 T 4	3ø	70,5	77,6	106	5	50/37	70,5	1280	190	61	91,5	122	5	40/30	61	1050	160	31,1	80	2100								
CFW11 0088 T 4	3ø	88	96,8	132	5	60/45	88	1480	220	73	110	146	5	50/37	73	1170	180	32,6	100	3150								

Modelli con 200... Alimentazione 240 V

Modelli con 380... Alimentazione 480 V

Tabel A.2: Technische specificaties van de bouwgrootten E t/m G

Model	Frame	Aantal stroomfasen	Gebruik bij Normal Duty-cyclus										Gebruik bij Heavy Duty-cyclus (HD)										Zekering [A] volgens de Europese IEC-norm	Zekering I ² t [A ² s] bij 25 °C	Omgevingstemperatuur [°C]	Dynamisch remmen	Kast	RFI-filter	Veiligheidsstop	Extern geregelde 24 V DC voeding	Beschikbaarheid van optiesets die in het product kunnen worden geïmplementeerd
			Overbelastingstromen ⁽²⁾ [A rms]		Nominale draagfrequentie [kHz]	Maximaal motorvermogen [pk/kW]	Nominale ingangsstroom [A rms]	Vermogensverlies [W]		Nominale draagfrequentie [kHz]	Maximaal motorvermogen [pk/kW]	Nominale ingangsstroom [A rms]	Overbelastingstromen ⁽²⁾ [A rms]		Nominale draagfrequentie [kHz]	Maximaal motorvermogen [pk/kW]	Nominale ingangsstroom [A rms]	Vermogensverlies [W]		Nominale draagfrequentie [kHz]	Maximaal motorvermogen [pk/kW]	Nominale ingangsstroom [A rms]									
1 min	3 s	Wandmontage	Flensmontage	1 min				3 s	Wandmontage				Flensmontage																		
CFW11 0142 T 2		3ø	142	156,2	213	2,5	50/37	142	1490	210	1490	210	115	172,5	230	5	40/30	115	1280	200	64,0	200	39200	-10... 45	Optioneel (het standaardproduct beschikt niet over de functie dynamisch remmen)	Nema 1 (set KNI-E-01)	Ingebouwd	Ja	Ja		
CFW11 0180 T 2		3ø	180	198	270	2,5	60/45	180	1820	360	1820	360	142	213	284	5	50/37	142	1550	350	65,0	200	218000	-10... 45		Nema 1 (set KNI-E-02)	Ingebouwd	Ja			
CFW11 0211 T 2		3ø	211	232	317	2,5	75/55	211	2040	360	2040	360	180	270	360	2,5	75/55	180	1690	350	65,0	250	218000	-10... 45		Nema 1 (set KNI-E-01)	Ingebouwd				
CFW11 0105 T 4	E	3ø	105	115,5	157,5	2,5	75/55	105	1270	200	1270	200	88	132	176	2,5	60/45	88	1020	190	62,5	125	39200	-10... 45		Nema 1 (set KNI-E-01)	Ingebouwd				
CFW11 0142 T 4		3ø	142	156,2	213	2,5	100/75	142	1680	210	1680	210	115	172,5	230	2,5	75/55	115	1290	200	64,0	200	39200	-10... 45		Nema 1 (set KNI-E-01)	Ingebouwd				
CFW11 0180 T 4		3ø	180	198	270	2,5	150/110	180	2050	360	2050	360	142	213	284	2,5	100/75	142	1570	350	65,0	200	218000	-10... 45		Nema 1 (set KNI-E-02)	Ingebouwd				
CFW11 0211 T 4		3ø	211	232,1	317	2,5	175/132	211	2330	360	2330	360	180	270	360	2,5	150/110	180	1940	350	65,0	250	218000	-10... 45		Nema 1 (set KNI-E-02)	Ingebouwd				
CFW11 0242 T 4		3ø	242	266	363	2,5	200/150	242	1518	285	1518	285	211	317	422	2,5	175/132	211	1277	227	130	320000	-10... 45			Ingebouwd					
CFW11 0312 T 4	F	3ø	312	343	468	2,5	250/185	312	2034	375	2034	375	242	363	484	2,5	200/150	242	1507	292	132	500	414000	-10... 45			Ingebouwd				
CFW11 0370 T 4		3ø	370	407	555	2,5	300/220	370	2497	407	2497	407	312	468	624	2,5	250/185	312	2008	320	135	500	414000	-10... 45			Ingebouwd				
CFW11 0477 T 4		3ø	477	525	716	2,5	400/300	477	3273	595	3273	595	370	555	740	2,5	300/220	370	2451	465	140	700	1051000	-10... 45			Ingebouwd				
CFW11 0515 T 4		3ø	515	567	773	2	400/300	515	3338	769	3338	769	477	716	954	2	400/300	477	2987	644	204	900	1445000	-10... 45			Ingebouwd				
CFW11 0601 T 4	G	3ø	601	662	900	2	500/370	601	3875	781	3875	781	515	773	1030	2	400/300	515	3219	639	207	900	1445000	-10... 45			Ingebouwd				
CFW11 0720 T 4		3ø	720	792	1080	2	600/440	720	4576	858	4576	858	560	840	1120	2	450/330	560	3747	653	215	1100	1445000	-10... 40			Ingebouwd				

Modelli con 380... Alimentazione 440 V

Opmerkingen:

- (1) Stabiele nominale stroom in de volgende condities:
 - Opgegeven schakelfrequenties;
 - Omgevingstemperatuur, zoals opgegeven in de tabellen. Voor hogere temperaturen, tot maximaal 10 °C boven de opgegeven maximumtemperatuur, moet de uitgangsstroom met 2 % worden gereduceerd voor elke graad °C boven de opgegeven maximumtemperatuur;
 - Relatieve luchtvochtigheid: 5 % tot 90 %, niet-condenserend;
 - Hoogte: 1000 m. Boven 1000 m tot 4000 m moet de uitgangsstroom met 1 % worden gereduceerd voor elke 100 m boven 1000 m.
 - Omgeving met vervuilingsgraad 2 (volgens EN50178 en UL508C);
- (2) De motorvermogens zijn slechts een leidraad voor vierpolige 230V- of 460V-motoren van WEG. De geschikte bouwafmeting van de omvormer moet worden gebaseerd op de betreffende nominale motorstroom.

Tabel A.3: Specificaties van de dynamische rem voor de bouwgrootten A t/m E

Omvormermodel	Maximale remstroom (I_{max}) [A]	Maximale remkracht (piekwaarde) (P_{max}) ⁽²⁾ [kW]	Effectieve remstroom (I_{eff}) ⁽¹⁾ [A]	Vermogensverlies (gemiddelde waarde) in de remweerstand (P_r) ⁽²⁾ [kW]	Aanbevolen weerstand [Ω]	Draaddikte voedingskabel (aansluitingen DC+ en BR) [mm ² (AWG)]
CFW11 0006 B 2	5,3	2,1	5,2	2,03	75	1,5 (16)
CFW11 0006 S 2 O FA	5,3	2,1	5,2	2,03	75	1,5 (16)
CFW11 0007 B 2	7,1	2,9	6,96	2,71	56	1,5 (16)
CFW11 0007 S 2 O FA	7,1	2,9	6,96	2,71	56	1,5 (16)
CFW11 0007 T 2	5,3	2,1	5,2	2,03	75	1,5 (16)
CFW11 0010 S 2	11,1	4,4	10,83	4,22	36	2,5 (14)
CFW11 0010 T 2	7,1	2,9	6,96	2,71	56	1,5 (16)
CFW11 0013 T 2	11,1	4,4	8,54	2,62	36	2,5 (14)
CFW11 0016 T 2	14,8	5,9	14,44	5,63	27	4 (12)
CFW11 0024 T 2	26,7	10,7	19,15	5,5	15	6 (10)
CFW11 0028 T 2	26,7	10,7	18,21	4,97	15	6 (10)
CFW11 0033 T 2	26,7	10,7	16,71	4,19	15	6 (10)
CFW11 0045 T 2	44	17,6	33,29	10,1	9,1	10 (8)
CFW11 0054 T 2	48,8	19,5	32,17	8,49	8,2	10 (8)
CFW11 0070 T 2	48,8	19,5	26,13	5,6	8,2	6 (8)
CFW11 0086 T 2	93	37,2	90,67	35,3	4,3	35 (2)
CFW11 0105 T 2	111,1	44,4	90,87	29,7	3,6	35 (2)
CFW11 0003 T 4	3,6	2,9	3,54	2,76	220	1,5 (16)
CFW11 0005 T 4	5,3	4,3	5,2	4,05	150	1,5 (16)
CFW11 0007 T 4	5,3	4,3	5,2	4,05	150	1,5 (16)
CFW11 0010 T 4	8,8	7	8,57	6,68	91	2,5 (14)
CFW11 0013 T 4	10,7	8,5	10,4	8,11	75	2,5 (14)
CFW11 0017 T 4	12,9	10,3	12,58	9,81	62	2,5 (12)
CFW11 0024 T 4	17	13,6	16,59	12,9	47	4 (10)
CFW11 0031 T 4	26,7	21,3	20,49	12,6	30	6 (10)
CFW11 0038 T 4	36,4	29,1	26,06	14,9	22	6 (8)
CFW11 0045 T 4	47,1	37,6	40	27,2	17	10 (8)
CFW11 0058 T 4	53,3	42,7	31,71	15,1	15	10 (8)
CFW11 0070 T 4	66,7	53,3	42,87	22,1	12	10 (6)
CFW11 0088 T 4	87,9	70,3	63,08	36,2	9,1	25 (4)
CFW11 0142 T 2 O DB	266,7	106,7	142	30,2	1,5	70 (2/0) of 2x 25 (2x 4)
CFW11 0180 T 2 O DB	266,7	106,7	180	48,6	1,5	120 (4/0) of 2x 35 (2x 2)
CFW11 0211 T 2 O DB	333,3	133,3	211	53,4	1,2	150 (300) of 2x 50 (2x 1)
CFW11 0105 T 4 O DB	186	148,8	105	47,4	4,3	50 (1)
CFW11 0142 T 4 O DB	266,7	213,3	142	60,5	3	70 (2/0) of 2x 25 (2x 4)
CFW11 0180 T 4 O DB	266,7	213,3	180	97,2	3	120 (4/0) of 2x 35 (2x 2)
CFW11 0211 T 4 O DB	363,6	290,9	191,7	80,8	2,2	120 (250) of 2x 50 (2x 1)

Opmerkingen:

(1) De opgegeven effectieve remstroom is slechts een indicatie, omdat deze afhangt van de reminschakelduur. De effectieve remstroom kan worden berekend via de onderstaande formule. t_{br} is in minuten en komt overeen met de som van alle remtijden tijdens de meest belaste cyclus van 5 (vijf) minuten.

$$I_{\text{effectief}} = I_{\text{max}} \cdot \sqrt{\frac{t_{br}}{5}}$$

(2) De opgegeven waarden P_{max} en P_r (resp. maximaal en gemiddeld vermogen van de remweerstand) gelden voor de aanbevolen weerstanden en voor de effectieve remstromen in de tabel. Het vermogen van de weerstand moet worden aangepast aan de reminschakelduur.



Convertitore di Frequenza

Guida di Installazione

Serie: CFW-11

Lingua: Italiano

Documento: 10001803811 / 00

Data pubblicazione: 01/2013

SOMMARIO

INFORMAZIONI SULLA GUIDA	147
ISTRUZIONI PER LA SICUREZZA.....	147
CFW-11 DESCRIZIONE GENERALE.....	147
RICEZIONE E STOCCAGGIO.....	147
INSTALLAZIONE MECCANICA.....	147
CONSIDERAZIONI DI CARATTERE GENERALE SUL MONTAGGIO.....	147
MONTAGGIO DEL CABINET.....	148
INSTALLAZIONE ELETTRICA.....	150
DIAGRAMMI DELLE CONNESSIONI.....	150
NOTE RELATIVE AI FORMATI E DISPOSITIVI	151
RETI IT	152
CONNESSIONI DI TERRA.....	152
CONNESSIONI DI CONTROLLO.....	153
INSTALLAZIONE CONFORME ALLA DIRETTIVA COMUNITARIA SULLA COMPATIBILITÀ' ELETTROMAGNETICA	155
TASTIERA INTEGRATA – HMI-CFW11	156
STRUTTURA DEI PARAMETRI.....	157
AVVIO.....	157
PRIMA DI ALIMENTARE	157
AVVIO IN MODALITÀ' V/F.....	157
IMPOSTAZIONE DI DATA E ORARIO	158
PREVENZIONE DI CAMBIAMENTO DI PASSWORD	158
FUNZIONI DEL MODULO DI MEMORIA FLASH.....	158
APPENDICE 1 – SPECIFICHE TECNICHE.....	159

INFORMAZIONI SULLA GUIDA

La presente guida illustra le procedure d'installazione e avvio in modalità V/f dei modelli d'inverter CFW-11 con dimensioni del telaio da A a G.

Per informazioni dettagliate si prega di fare riferimento al manuale di programmazione ed al manuale utente CFW-11.

CFW-11 può operare anche nelle seguenti modalità di controllo: VVW, Controllo vettoriale sensorless e Controllo vettoriale con encoder, per i motori ad induzione e Controllo vettoriale, sensorless e con encoder, per la macchine PM (Permanent Magnet) a magnete permanente. Si prega di consultare il manuale di programmazione.

Per informazioni su altre funzioni, accessori e comunicazioni, si prega di accedere al sito web WEG www.weg.net per scaricare i manuali.

ISTRUZIONI PER LA SICUREZZA

Leggere interamente questa guida prima di installare o utilizzare l'inverter.

L'installazione, la messa in esercizio e le operazioni di diagnostica su questa apparecchiatura devono essere svolte esclusivamente da personale addestrato e qualificato. Il personale è tenuto ad osservare tutte le istruzioni per la sicurezza descritte in questa guida e/o specificate nelle normative locali.



PERICOLO!

La mancata osservanza delle istruzioni per la sicurezza può esporre al rischio di morte, lesioni gravi e danni alle apparecchiature.

Disconnettere sempre l'alimentazione elettrica prima di toccare qualsiasi dispositivo elettrico connesso all'azionamento o le parti elettricamente attive.

Diversi componenti possono mantenere tensioni elevate e/o restare in movimento (ventole) anche dopo la disconnessione dell'alimentazione CA o lo spegnimento dell'apparecchiatura.

Attendere almeno 10 minuti per consentire ai condensatori di scaricarsi completamente.

Collegare sempre il telaio dell'apparecchiatura ad una protezione di terra (PE).



NOTA!

In questa guida, con personale qualificato, si fa riferimento a persone addestrate in grado di:

1. Installare, mettere a terra, accendere ed azionare l'apparecchiatura CFW-11 in accordo con questa guida e con le norme vigenti riguardanti la sicurezza elettrica.
2. Adottare le attrezzature protettive in accordo con le normative ufficiali.
3. Provvedere alle misure di primo soccorso.



NOTA!

Il convertitore di frequenza può interferire con altri dispositivi elettronici.

Seguire le istruzioni per l'installazione per minimizzare questi effetti.

CFW-11 DESCRIZIONE GENERALE

Le linea di convertitori di frequenza CFW-11 e lo stato dell' arte della tecnologia per il controllo di motori od 3-fasiei ed é disponibile con modelli tra 1 e 600 HP (da 0.75 a 450 kW) in sette differenti o telai meccanici e con tensioni comprese tra 200 V e 480 V. É progettato per il controllo della velocità e della torsione di motori ad induzione trifasici e di motori PM. La caratteristica principale di questo prodotto è la tecnologia "Vectrue", con le seguenti modalità operative: Controllo scalare (V/f), VVW, "Controllo vettoriale sensorless" e "Controllo vettoriale con encoder". Ulteriori funzioni e caratteristiche: "Optimal Braking", "Self-Tuning" e "Optimal Flux".

Per informazioni dettagliate si prega di fare riferimento al manuale di programmazione ed al manuale utente CFW-11.

RICEZIONE E STOCCAGGIO

Alla ricezione del prodotto, verificare se:

Il dati sulla targhetta identificativa corrispondono all'ordine d'acquisto. Fare riferimento ai modelli ed alle specifiche tecniche elencati nelle [tabelle A.1](#) e [A.2](#).

L'eventuale presenza di danni dovuti al trasporto. In caso di problemi, contattare immediatamente il trasportatore.

Se il CFW-11 non deve essere installato immediatamente, può essere stoccato nel suo imballo originale in una stanza pulita ed asciutta (temperatura di stoccaggio compresa tra a -25 °C (-13 °F) ed 60 °C (140 °F).

INSTALLAZIONE MECCANICA

AMBIENTE

Evitare:

- L'esposizione diretta a sole, pioggia, umidità elevate o salsedine.
- Gas o liquidi infiammabili o corrosivi.
- Vibrazioni eccessive.
- Polvere, particelle metalliche e nebbia d'olio.
- Condizioni ambientali in accordo con le [tabelle A.1](#) e [A.2](#).

CONSIDERAZIONI DI CARATTERE GENERALE SUL MONTAGGIO

Peso dell'inverter in accordo con le [tabelle A.1](#) e [A.2](#).

Montare l'inverter in posizione verticale su una superficie piana e verticale.

Le posizioni dei fori di fissaggio sono indicati in [figura 1](#).

Le distanze minime da rispettare per la corretta ventilazione sono indicate nella [figura 2](#).

Nota:

- Per i formati A, B e C: montaggio affiancati - gli azionamento non devono essere necessariamente distanziati se si rimuove il coperchio superiore.

Non installare immediatamente sopra all'inverter componenti suscettibili al calore.

MONTAGGIO DEL CABINET

Montaggio su superficie:

Provvedere ad una ventilazione in grado di garantire che la temperatura all'interno del cabinet rimanga entro l'intervallo consentito per il corretto funzionamento dell'inverter.

La potenza dissipata alle condizioni nominali è specificata nelle [tabelle A.1 e A.2](#) "Potenza dissipata in Watt – Montaggio su superficie".

I requisiti minimi di ventilazione sono indicati nella [tabella 1](#).

La posizione ed il diametro di fori di montaggio sono indicati nella [figura 1](#).

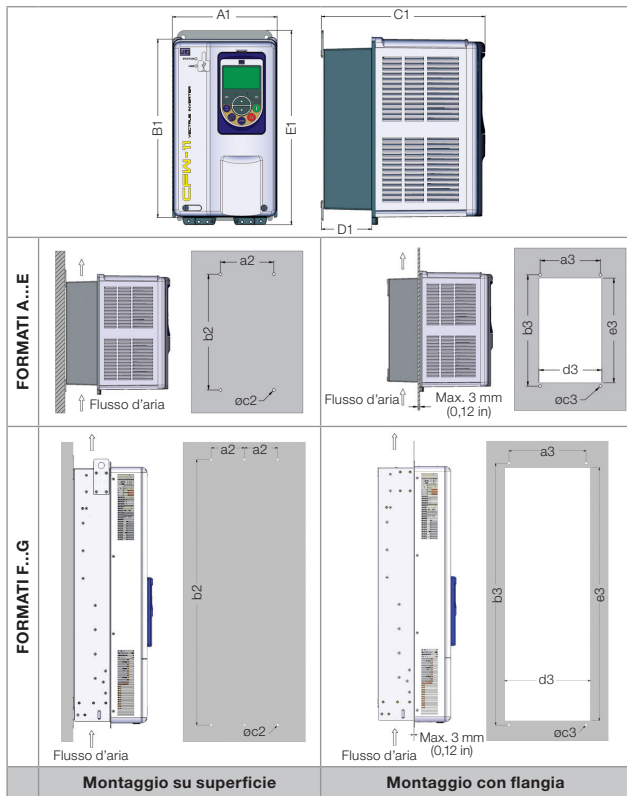

Modello	A1	B1	C1	D1	E1	a2	b2	c2	a3	b3	c3	d3	e3
mm (in)	mm (in)	mm (in)	mm (in)	mm (in)	mm (in)	mm (in)	mm (in)	M	mm (in)	mm (in)	M	mm (in)	mm (in)
Telaio A	145 (5,71)	247 (9,73)	227 (8,94)	70 (2,75)	270 (10,63)	115 (4,53)	250 (9,85)	M5	130 (5,12)	240 (9,45)	M5	135 (5,32)	225 (8,86)
Telaio B	190 (7,48)	293 (11,53)	227 (8,94)	71 (2,78)	316 (12,43)	150 (5,91)	300 (11,82)	M5	175 (6,89)	285 (11,23)	M5	179 (7,05)	271 (10,66)
Telaio C	220 (8,67)	378 (14,88)	293 (11,53)	136 (5,36)	405 (15,95)	150 (5,91)	375 (14,77)	M6	195 (7,68)	365 (14,38)	M6	205 (8,08)	345 (13,59)
Telaio D	300 (11,81)	504 (19,84)	305 (12,00)	135 (5,32)	550 (21,65)	200 (7,88)	525 (20,67)	M8	275 (10,83)	517 (20,36)	M8	285 (11,23)	485 (19,10)
Telaio E	335 (13,19)	620 (24,41)	358 (14,09)	168 (6,61)	675 (25,57)	200 (7,88)	650 (25,59)	M8	275 (10,83)	635 (25,00)	M8	315 (12,40)	615 (24,21)
Telaio F	430 (16,93)	1156 (45,51)	360 (14,17)	169 (6,65)	1234 (48,58)	150 (5,91)	1200 (47,24)	M10	350 (13,78)	1185 (46,65)	M10	391 (15,39)	1146 (45,12)
Telaio G	535 (21,06)	1190 (46,85)	426 (16,77)	202 (7,95)	1264 (49,76)	200 (7,87)	1225 (48,23)	M10	400 (15,75)	1220 (48,03)	M10	495 (19,49)	465,3 (18,32)

Tolleranza per d3 e e3: +1,0 mm (+0,039 in)
Tolleranza generale: ±1,0 mm (±0,039 in)

Figura 1: Dettagli sull'installazione meccanica

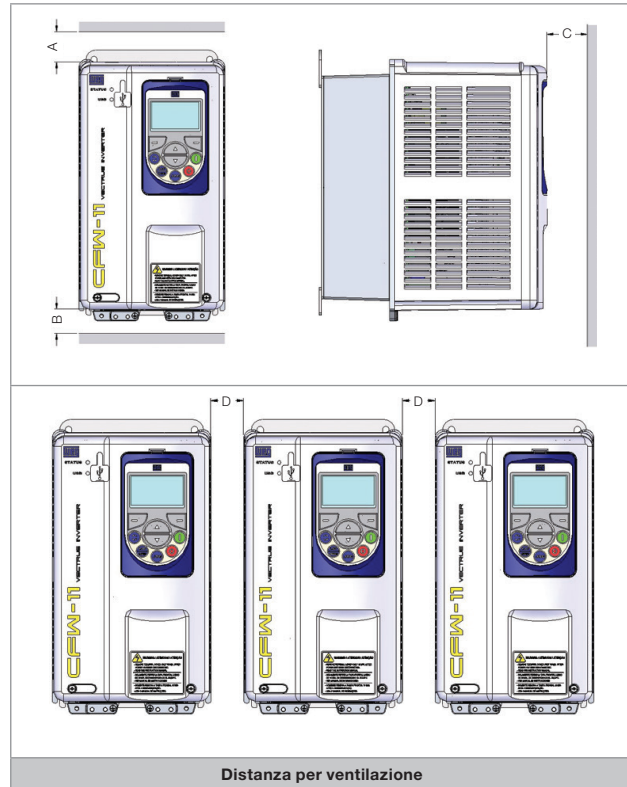

Modello	A	B	C	D		
	mm (in)	mm (in)	mm (in)	mm (in)		
Telaio A	25 (0,98)	25 (0,98)	10 (0,39)	30 (1,18)		
Telaio B	40 (1,57)	45 (1,77)				
Telaio C	110 (4,33)	130 (5,12)				
Telaio D			20 (0,78)	80 (3,15)		
Telaio E	0142 T2	100 (3,94)			130 (5,12)	40 (1,57)
	0180 T2	150 (5,91)			250 (9,84)	80 (3,15)
	0211 T2	100 (3,94)			130 (5,12)	40 (1,57)
	0142 T4	150 (5,91)			250 (9,84)	80 (3,15)
	0180 T4					
	0211 T4					
Telaio F						
Telaio G						

Tolleranza: ±1,0 mm (±0,039 in)

Figura 2: Spazio libero per la ventilazione dell'inverter

Tabella 1: Flusso d'aria minimo richiesto per il raffreddamento del cabinet

Telaio	Modello	CFM	l/s	m³/min
A	TUTTI	18	8	0,5
B	TUTTI	42	20	1,2
C	TUTTI	96	45	2,7
D	TUTTI	132	62	3,7
E	CFW11 0142 T 2	138	65	3,9
	CFW11 0180 T 2	265	125	7,5
	CFW11 0211 T 2			
	CFW11 0105 T 4	138	65	3,9
	CFW11 0142 T 4	180	95	5,1
	CFW11 0180 T 4	265	125	7,5
CFW11 0211 T 4				
CFW11 0242 T 4				
F	CFW11 0242 T 4	250	118	7,1
	CFW11 0312 T 4	320	151	9,1
	CFW11 0370 T 4	380	180	10,1
	CFW11 0477 T 4	460	217	13
	CFW11 0515 T 4	680	321	19,3
CFW11 0601 T 4				
CFW11 0720 T 4				

Montaggio con flangia:

Nelle [tabelle A.1 e A.2](#) "Potenza dissipata in Watt - Montaggio con flangia" viene indicata la potenza dissipata all'interno del cabinet. La rimanente dispersione verrà dissipata dal lato posteriore.

I supporti di fissaggio dell'inverter e degli occhielli, devono essere rimossi e riposizionati per i telaio de dimensioni E, F e G. Vedi [figure 3 e 4](#).

La porzione di azionamento esterna al cabinet ha grado di protezione IP54, per i telaio de formati da A ad E. Per i telaio F e G il grado di protezione è IP20.

Per mantenere il grado di protezione dell'inverter utilizzare una guarnizione a tenuta adeguata per le aperture del cabinet. Esempio: guarnizione in silicone.

Le dimensioni delle aperture della superficie di montaggio e le posizioni/diametri dei fori di montaggio sono indicate nella [figura 1](#).



Figura 3: Riposizionare i supporti di montaggio per i telai da A ad E. Per i formati F e G i supporti di montaggio devono essere rimossi



Figura 4: Installazione delle staffe ad occhiello - Telai E, F e G

Accesso ai Terminali di Controllo ed Alimentazione

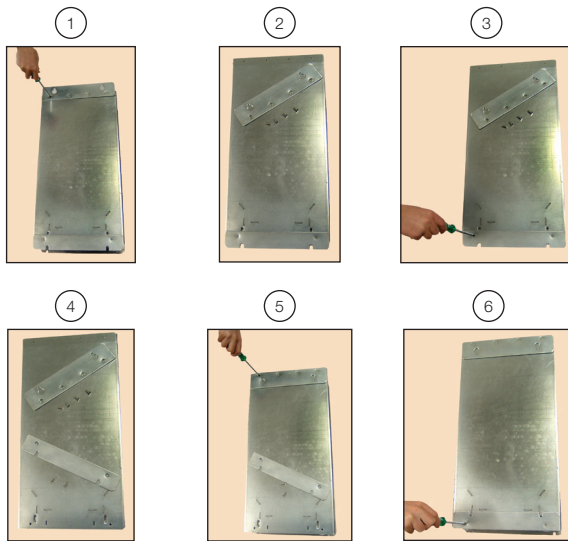
Per accedere ai terminali di controllo ed alimentazione, per i telai da A a C è necessario rimuovere la tastiera HMI ed il coperchio dei controlli. Vedi [figura 5](#).

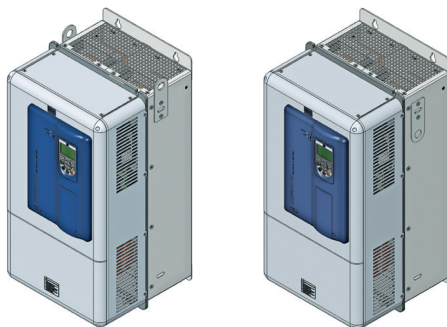

Figura 5: Rimozione della tastiera HMI e del coperchio dei controlli



Figura 6: Rimozione della tastiera HMI e del coperchio rack di controllo nei telai D, E, F e G per accedere ai terminali di controllo

Per accedere ai terminali di alimentazione, nei telai da D a G è necessario rimuovere il coperchio anteriore inferiore come indicato in [figura 7](#).

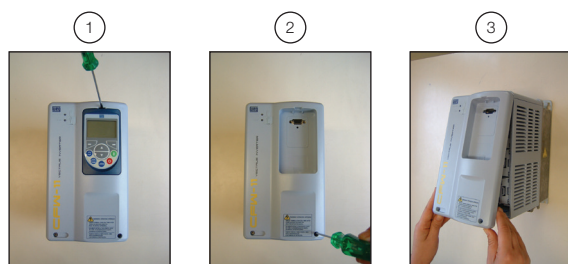

Figura 7: Rimozione del coperchio anteriore inferiore, per accedere ai terminali di alimentazione nei formati da D a G

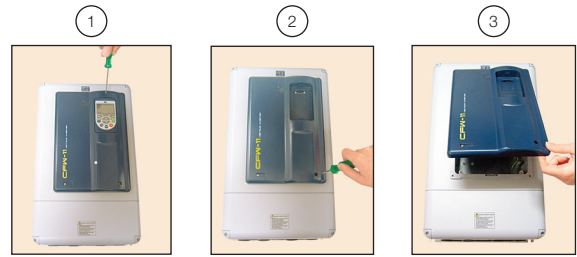
Quando non è necessaria la protezione, né IP20, né Nema1, è possibile rimuovere la piastra di passaggio cavi nei formati D ed E.

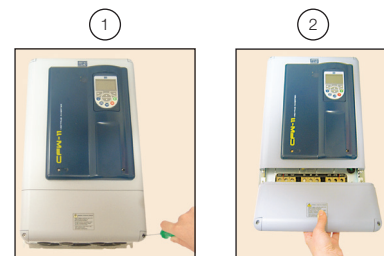

Figura 8: Rimozione della piastra passaggio cavi

Nei formati F e G, rimuovere sempre la piastra inferiore per la connessione dei cavi di alimentazione (linea e motore), come indicato in [figura 9](#).

In tal caso il grado di protezione della parte inferiore dell'inverter verrà ridotto.

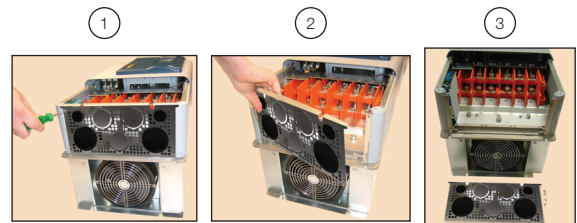

Figura 9: Rimozione della piastra passaggio cavi nei formati F e G

INSTALLAZIONE ELETTRICA

PERICOLO!
Assicurarsi che l'alimentazione elettrica CA sia scollegata prima di iniziare l'installazione.

PERICOLO!
Le seguenti informazioni sono semplicemente una guida alla corretta installazione. Attenersi alle leggi locali per le installazioni elettriche.

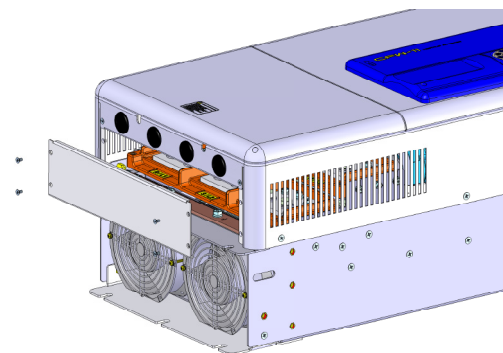
PERICOLO!
L'azionamento subirà danni se l'alimentazione di ingresso viene collegata ai terminali di uscita.

DIAGRAMMI DELLE CONNESSIONI

Note:
Le specifiche tecniche inclusi i fusibili di linea sono indicati nelle tabelle A.1 ed A.2.

Le specifiche tecniche delle resistenze di frenatura e le correnti di frenatura in tabelle A.3.



Figura 10: Diagramma delle connessioni per telaio standard in telaio A, B, C, D, E, F e G



Figura 11: Diagramma delle connessioni per telai F e G con hardware CC speciale

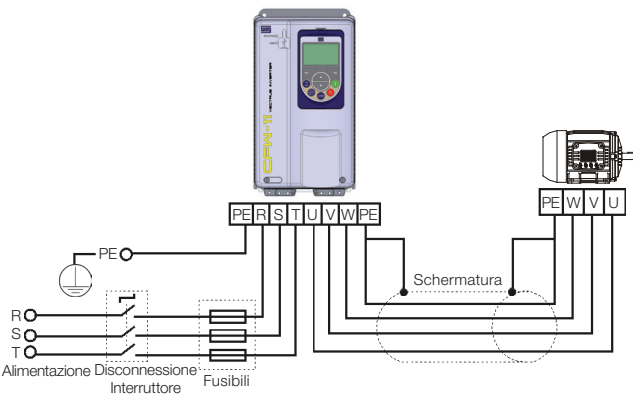

Figura 12: Diagramma delle connessioni delle resistenze di frenatura per telai A, B, C, D ed E

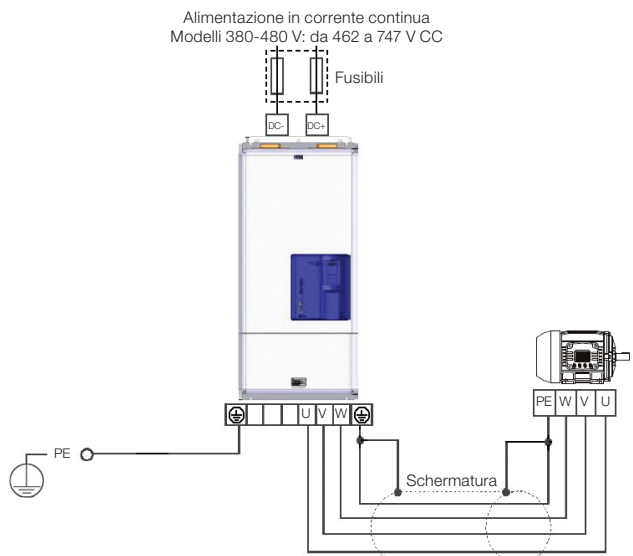

Figura 13: Diagramma delle connessioni per telai F e G con resistenza di frenatura

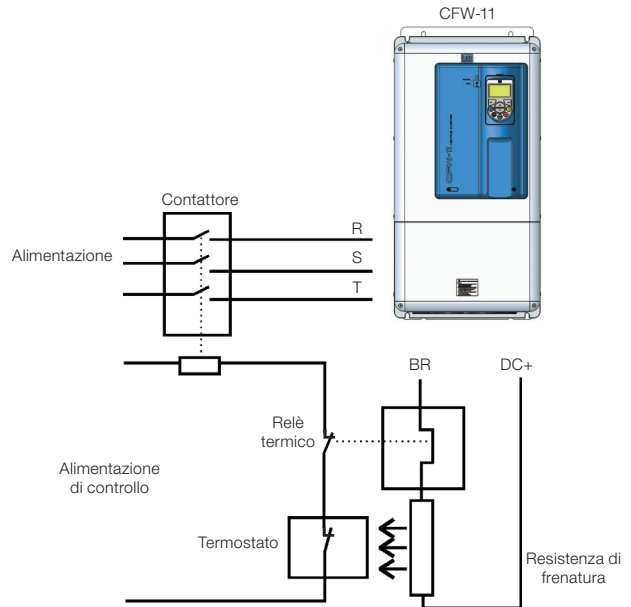

Figura 14 (a): Terminali di alimentazione e messa a terra telai da A ad C

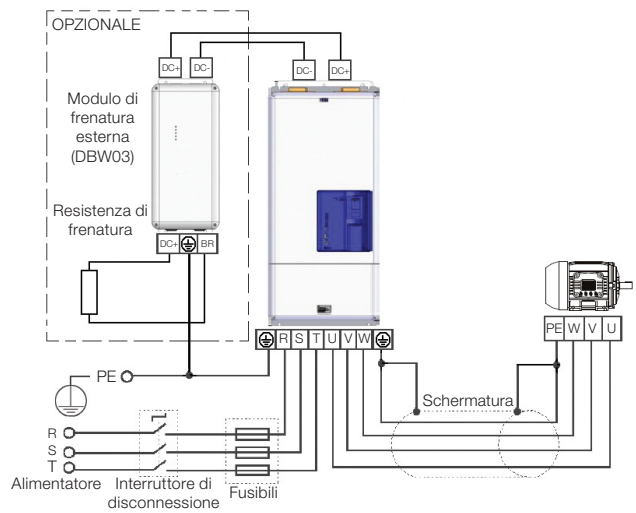

Figura 14 (b) e (c): Terminali di alimentazione e messa a terra telai da D ad E

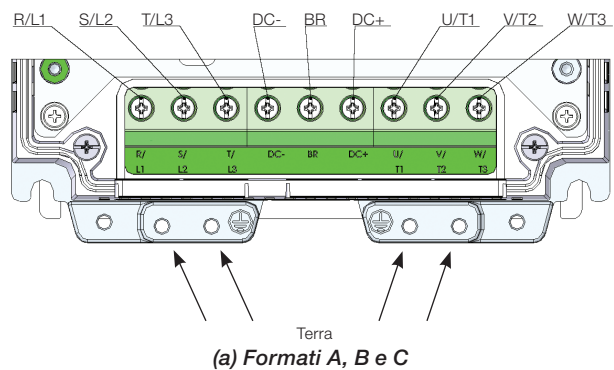

Figura 15 (a) e (b): Terminali di alimentazione e messa a terra telai F e G

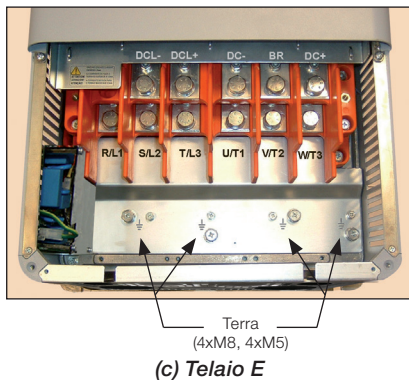
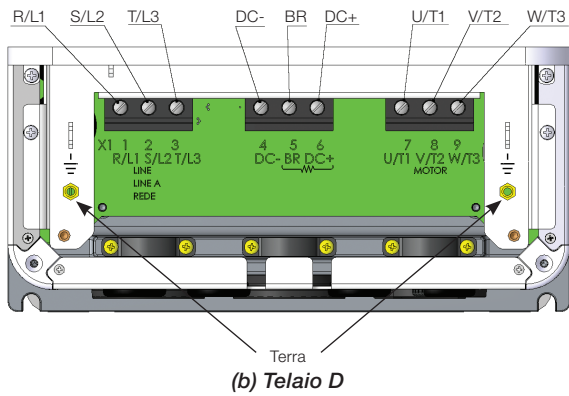

Figura 16: Connessione del modulo di frenatura dinamica per i telai F e G standard

NOTE RELATIVE AI FORMATI E DISPOSITIVI

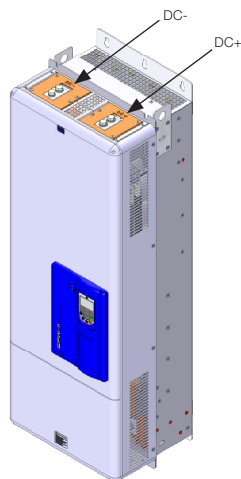
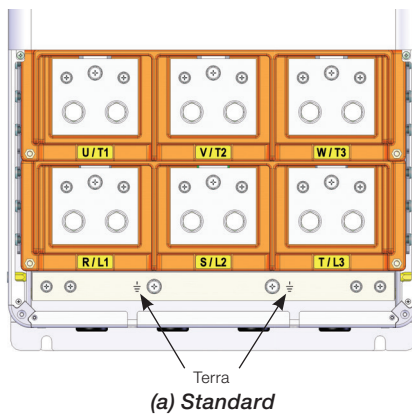
- L'alimentazione che alimenta l'azionamento deve avere il neutro a terra. Per reti IT alcuni componenti interni devono venire scollegati come illustrato nelle figure da 17 a 19.
- Predisporre un dispositivo di disconnessione per l'alimentazione di ingresso dell'inverter. Questo dispositivo deve scollegare l'alimentazione di ingresso per l'inverter, se necessario (per esempio per manutenzione).
- Utilizzare fusibili ad alta velocità sull'ingresso per la protezione del raddrizzatore e cablaggio dell'azionamento. Fare riferimento alle tabelle A.1 e A.2 per selezionare il tipo di fusibile (I²t deve essere uguale o minore a quanto indicato nelle tabelle, in considerazione del valore di normale funzionamento (e non di fusione)).
- Per conformarsi ai requisiti UL, utilizzare fusibili di classe J all'alimentazione dell'inverter con corrente non superiore ai valori delle tabelle A.1 e A.2.
- Opzionalmente possono essere impiegati all'ingresso fusibili lenti. Devono essere dimensionati per 1,2 volte la corrente nominale dell'azionamento. In tal caso l'installazione viene protetta contro i cortocircuiti, ma non il raddrizzatore di ingresso dell'azionamento. Ne può risultare un maggior danno all'azionamento in caso di guasto di un componente interno.
- Gli azionamento CFW-11, sono ideati per l'utilizzo in un circuito capace di fornire fino a un massimo di 100,000 Arms simmetrico (230 V / 480 V).
- Si consiglia l'uso di cavo schermato per motore conforme a IEC 60034-25.
- Mantenere i cavi motore ad almeno 25 cm (9,84 in) da altri cavi, come cavi per segnali, cavi di sensori, cavi di controllo, ecc.

RETI IT

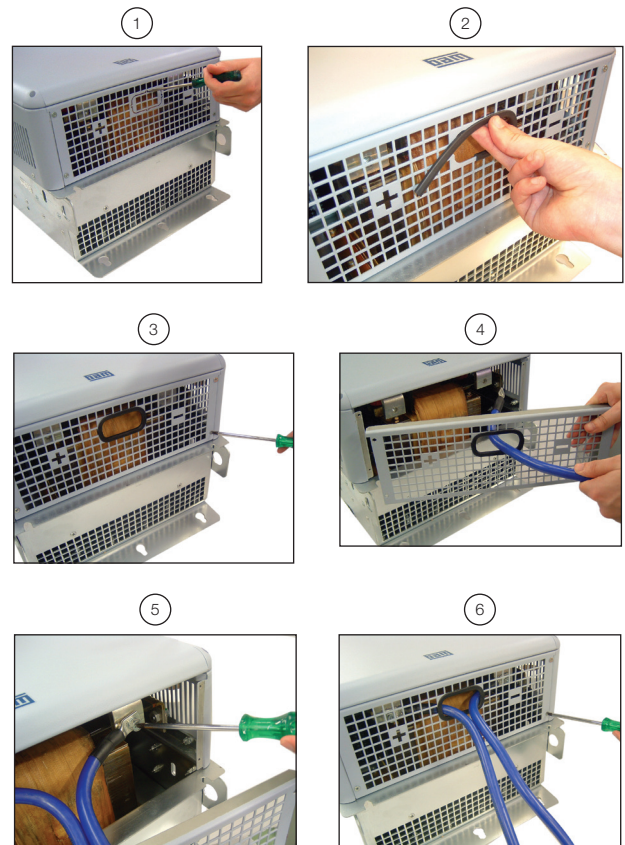
Quando il neutro non è messo a terra, o la messa a terra viene fornita da una resistenza di elevato valore in ohm o in reti con triangolo a terra ("vertice del triangolo a terra").



Figura 17 da (a) a (d): Formati da A a D - Posizione delle viti di messa a terra - Rimuovere per reti IT



(a) Posizione della scheda

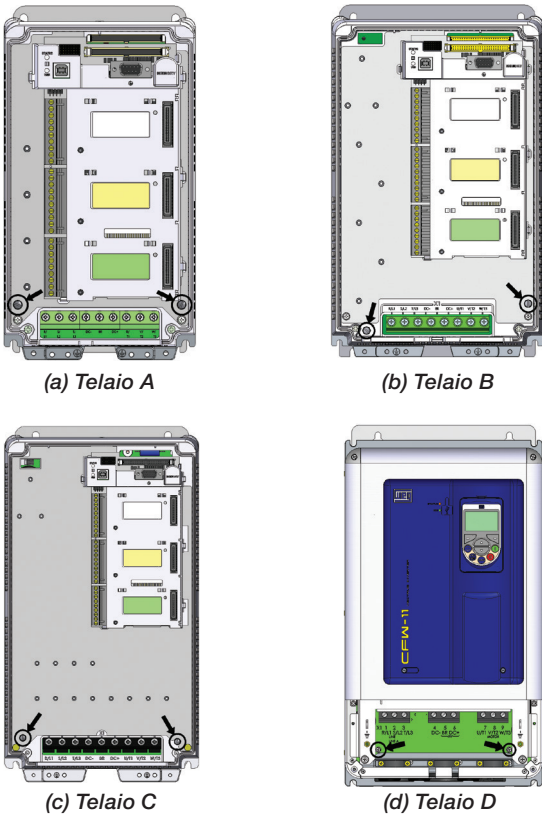
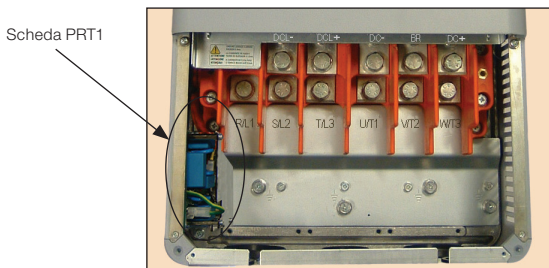
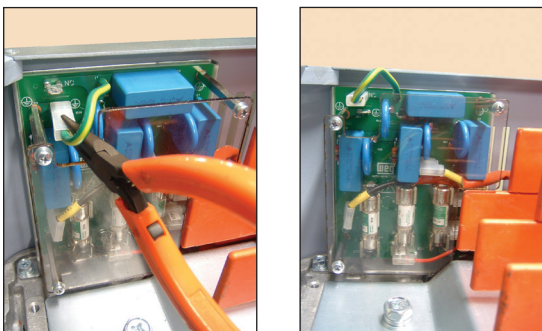

(b) Posizione iniziale (c) Posizione finale (IT)

Figura 18 da (a) a (c): Telaio E - Posizione del terminale su scheda PRT1 - Cambiare posizione per reti IT

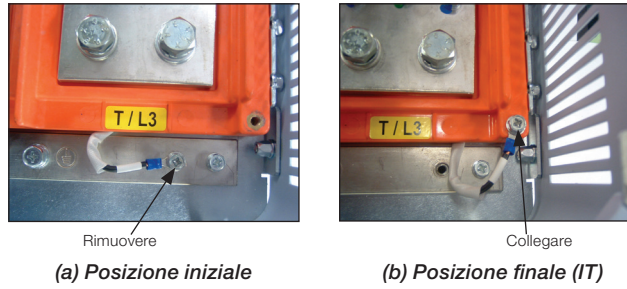

(a) Posizione iniziale (b) Posizione finale (IT)

Figura 19 (a) e (b): Formati F e G - posizione del terminale su scheda PRT1 - cambiare posizione per reti IT

CONNESSIONI DI TERRA



PERICOLO!

Collegare sempre la messa a terra dell'azionamento ad una protezione di terra (PE).

Fare riferimento sempre a regolamenti locali e/o a norme elettriche per la selezione della sezione dei cavi di messa a terra.

Collegare le connessioni di messa a terra dalla barra di terra, ad un singolo punto di terra o ad un punto comune di messa a terra (impedenza $\leq 10 \Omega$).

Per garantire la conformità con lo standard IEC 61800-5-1 standard, collegare a terra l'inverter mediante un cavo in rame con singolo conduttore con sezione di almeno 10 mm^2 , poiché la corrente di dispersione è maggiore di $3,5 \text{ mA CA}$.



ATTENZIONE!

Il conduttore neutro dell'alimentazione elettrica deve essere messo a massa. Tuttavia questo conduttore non deve essere utilizzato per mettere a terra l'azionamento.



Figura 20: Connessioni a terra di più azionamento

CONNESSIONI DI CONTROLLO

Le connessioni di controllo (ingressi e uscite analogiche, ingressi e uscite digitali), devono essere realizzate sulla morsetteria CC11 XC1 della scheda di controllo.

	XC1 Morsetteria	Funzione predefinita in fabbrica
	1	REF+
	2	AI1+
	3	AI1-
	4	REF-
	5	AI2+
	6	AI2-
	7	AO1
	8	AGND (24 V)
	9	AO2
	10	AGND (24 V)
	11	DGND*
	12	COM
	13	24 V CC
	14	COM
	15	DI1
	16	DI2
	17	DI3
	18	DI4
	19	DI5
	20	DI6
	21	NC1
	22	C1
23	NO1	
	24	NC2
	25	C2
	26	NO2
	27	NC3
	28	C3
	29	NO3

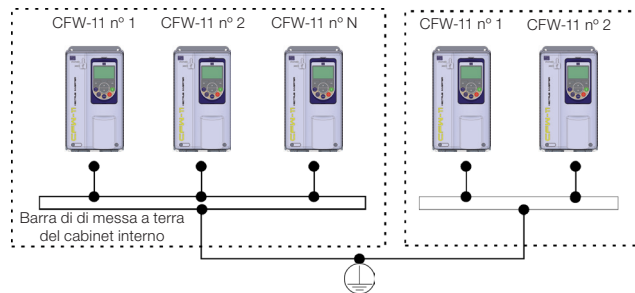
Figura 21: Segnali sul connettore XC1 - input digitali in modalità "Attivo Alto"



NOTA!

Per funzionamento in modalità "Attivo Basso" rimuovere i ponticelli tra XC1:11 e 12, posizionare tale ponticello tra XC1:12 e 13 e collegare i punti in comune degli interruttori da DI1 a DI6 a XC1:11, anziché XC1:13.

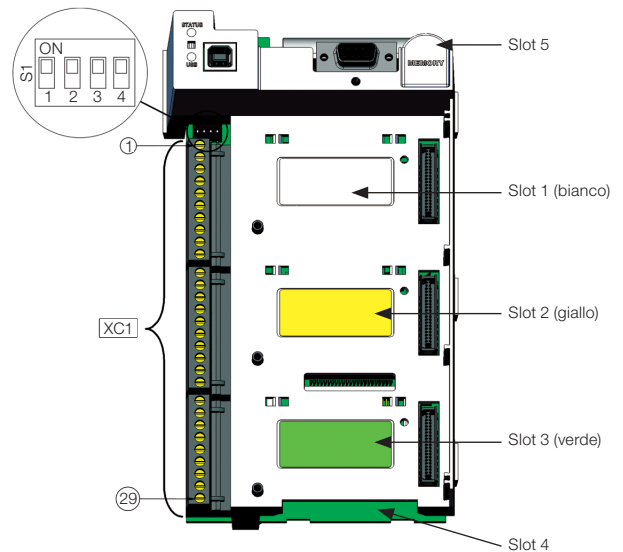

Segnale	Funzione predefinita in fabbrica	DIP-switch	Selezione	Impostazione di fabbrica
AI1	Riferimento velocità (remoto)	S1.4	OFF: da 0 a 10 V (impostazione di fabbrica) ON: da 4 a 20 mA / da 0 a 20 mA	OFF
AI2	Nessuna funzione	S1.3	OFF: da 0 a ±10 V (impostazione di fabbrica) ON: da 4 a 20 mA / da 0 a 20 mA	OFF
AO1	Velocità	S1.1	OFF: da 4 a 20 mA / da 0 a 20 mA ON: da 0 a 10 V (impostazione di fabbrica)	ON
AO2	Corrente motore	S1.2	OFF: da 4 a 20 mA / da 0 a 20 mA ON: da 0 a 10 V (impostazione di fabbrica)	ON

Figura 22: DIP Switch per impostare il tipo di segnale su ingressi ed uscite analogici



NOTA!

Per informazioni sulla funzione di arresto di sicurezza (STO) consultare la guida all'installazione, configurazione ed utilizzo.



Connessioni di controllo tipiche

Connessione di controllo #1 - Funzione Run/Stop controllata da tastiera (Modalità Locale).

Con questa connessione di controllo, è possibile for operare in modalità locale con le impostazioni di fabbrica l'azionamento. Questa modalità di operazione è consigliata per l'utilizzo iniziale, poiché non richiede ulteriori connessioni di controllo.

Connessione di controllo #2 - Funzione Run/Stop a 2 conduttori (Modalità Remota).

Questo esempio di connessione è valido solo per le impostazioni di fabbrica e se l'azionamento è impostato in modalità remota.

Con le impostazioni di fabbrica, la selezione della modalità di funzionamento (locale/remota) viene realizzata mediante tasto HMI  (impostazione di fabbrica: modalità locale). Impostare P0220=3 per cambiare l'impostazione di fabbrica del tasto HMI  in modalità Remota.



Figura 23: Cablaggio XC1 per la connessione di controllo # 2

Connessione di controllo #3 - Funzione Run/Stop a 3 conduttori.

Abilitazione della funzione Run/Stop con controllo a 3 conduttori.

Parametri da impostare:

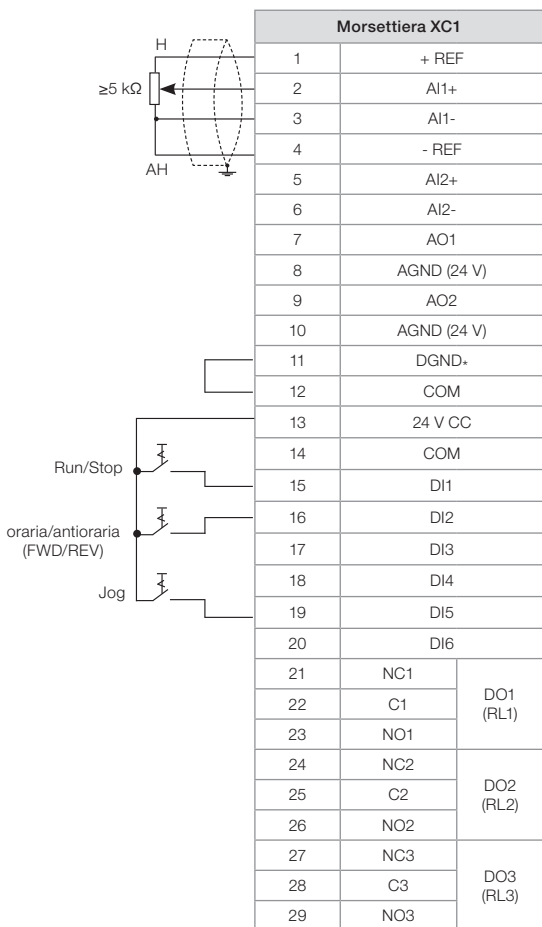
Impostare DI3 su START: P0265=6

Impostare DI4 su STOP: P0266=7

Impostare P0224=1 (DIx) per il controllo a 3-conduttori in modalità Locale.

Impostare P0227=1 (DIx) per il controllo a 3 conduttori in modalità Remota.

Impostare Forward/Reverse tramite l'ingresso digitale # 2 (DI2).

Impostare P0223=4 per la modalità Locale o P0226=4 per la modalità Remota.

S1 ed S2 sono rispettivamente i pulsanti Start (contatto NO) e Stop (contatto NC).

Il riferimento di velocità può essere fornito attraverso l'ingresso analogico (connessione di controllo # 2), attraverso la tastiera (connessione di controllo # 1) o attraverso un'altra sorgente disponibile.



Figura 24: Cablaggio XC1 per la connessione di controllo # 3



Connessione di controllo # 4 - Forward/Reverse (Oraria/Antioraria).

Abilitare la funzione Forward/Reverse.

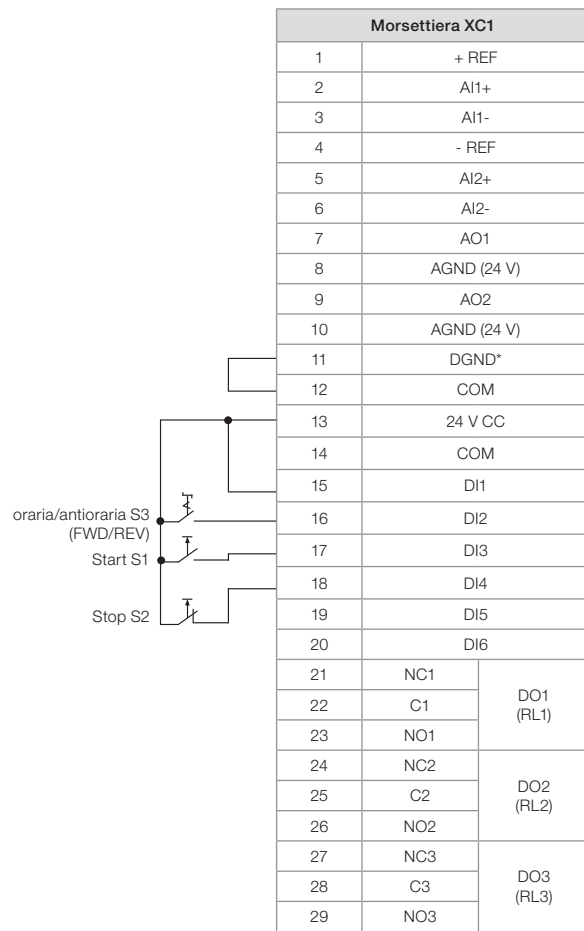
Parametri da impostare:

Impostare DI3 su Forward: P0265=4

Impostare DI4 su Reverse: P0266=5

Quando la funzione Forward/Reverse è impostata, sarà attiva sia in modalità Locale sia in modalità Remota. Contemporaneamente, i tasti HMI  e  rimarranno sempre inattivi (anche se P0224=0 o P0227=0).

La direzione di rotazione è definita dagli ingressi Forward e Reverse. Direzione di rotazione oraria per movimento Forward e antioraria per Reverse.

Il riferimento di velocità può essere fornito da qualsiasi sorgente (come per la connessione di controllo # 3).



Figura 25: Cablaggio XC1 per la connessione di controllo # 4

INSTALLAZIONE CONFORME ALLA DIRETTIVA COMUNITARIA SULLA COMPATIBILITÀ ELETTRICITÀ

Gli azionamento in telaio da A a D con opzione FA (CFW11XXXXXXOFA) e tutti gli azionamento standard negli altri formati dispongono di un filtro RFI per la riduzione delle interferenze elettromagnetiche. Tali azionamento, se correttamente installati, sono conformi ai requisiti della direttiva sulla compatibilità elettromagnetica „EMC 2004/108/CE“.

ATTENZIONE!

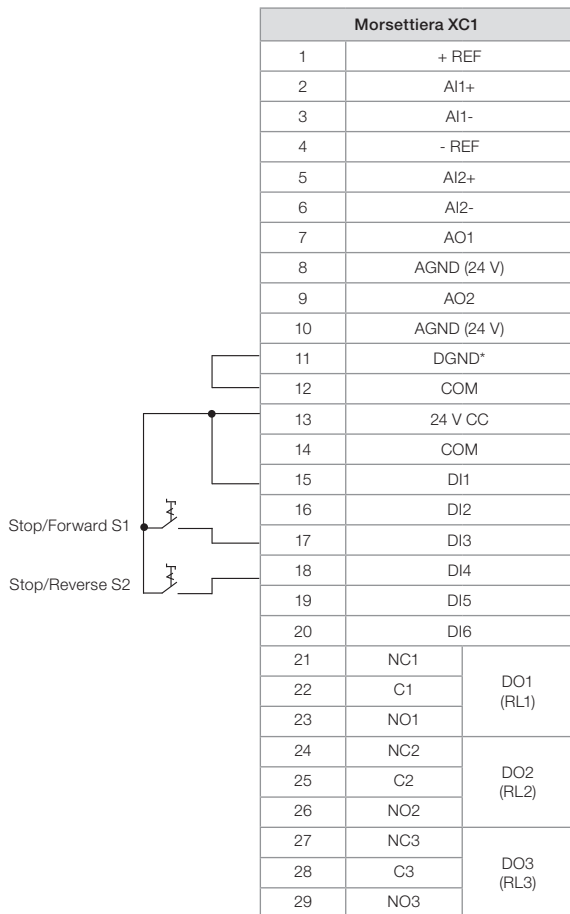
Per l'utilizzo di modelli con filtri RFI interni in reti IT, fare riferimento alle istruzioni nelle [figure da 17 a 19](#).

Installazione conforme

Per l'installazione conforme, fare uso di:

1. Azionamento nei formati da A a D: con opzione filtri RFI interni CFW11XXXXXXOFA e altri modelli standard.
2. Cavi di uscita schermati (cavi motore) collegando lo schermo ad entrambe le estremità (motore e azionamento) mediante connessione a bassa impedenza per alta frequenza. Lunghezza massima dei cavi motore e livelli di emissione condotta ed emessa secondo le [tabelle 2 e 3](#). Qualora fosse necessario un livello di emissione inferiore e/o un cavo più lungo, occorre provvedere ad un filtro RFI esterno all'ingresso dell'inverter. Per ulteriori informazioni (riferimenti commerciali dei filtri RFI, lunghezze cavi motore e livelli di emissione) fare riferimento alle [tabelle 2 e 3](#).
3. Cavi di controllo schermati.
4. Robusta messa a terra dell'inverter.

Tabella 2: Livelli di emissione condotta e radiata per telaio da A a D

Modello Azionamento (con filtro RFI integrato)	Senza Filtro RFI esterno			Con filtro RFI esterno				
	Emissione condotta - lunghezza massima cavo motore		Emissione radiata	Filtro RFI esterno codice prodotto (produttore: EPCOS)				
	Categoria C3	Categoria C2		Emissione condotta - lunghezza massima cavo motore		Radiata - categoria emissione - categoria	Senza cabinet metallico All'interno di cabinet metallico	Categoria C2
			Categoria C3	Categoria C2	Categoria C2			
CFW11 0006 S 2 O FA	100 m (328,10 ft)	7 m (23,00 ft)	C2	B84142-A16-R122	75 m (246,06 ft)	50 m (164,04 ft)	C2	C2
				B84142-B16-R	100 m (328,10 ft)	-		
CFW11 0007 T 2 O FA	100 m (328,10 ft)	5 m (16,40 ft)	C2	B84143-G8-R110	100 m (328,10 ft)	-	C2	C2
				B84143-A8-R105	50 m (164,04 ft)	50 m (164,04 ft)		
CFW11 0007 S 2 O FA	100 m (328,10 ft)	7 m (23,00 ft)	C2	B84142-A16-R122	75 m (246,06 ft)	50 m (164,04 ft)	C2	C2
				B84142-B16-R	100 m (328,10 ft)	100 m (328,10 ft)		
CFW11 0010 S 2 O FA	100 m (328,10 ft)	7 m (23,00 ft)	C2	B84142-A30-R122	75 m (246,06 ft)	50 m (164,04 ft)	C2	C2
				B84142-B25-R	100 m (328,10 ft)	100 m (328,10 ft)		
CFW11 0010 T 2 O FA	100 m (328,10 ft)	5 m (16,40 ft)	C2	B84143-G20-R110	100 m (328,10 ft)	-	C2	C2
				B84143-A16-R105	50 m (164,04 ft)	50 m (164,04 ft)		
CFW11 0013 T 2 O FA	100 m (328,10 ft)	5 m (16,40 ft)	C2	B84143-G20-R110	100 m (328,10 ft)	-	C2	C2
				B84143-A16-R105	50 m (164,04 ft)	50 m (164,04 ft)		
CFW11 0016 T 2 O FA	100 m (328,10 ft)	5 m (16,40 ft)	C2	B84143-G20-R110	100 m (328,10 ft)	-	C2	C2
				B84143-A25-R105	50 m (164,04 ft)	50 m (164,04 ft)		
CFW11 0024 T 2 O FA	100 m (328,10 ft)	No	C2	B84143-A36-R105	100 m (328,10 ft)	100 m (328,10 ft)	C2	C2
CFW11 0028 T 2 O FA	100 m (328,10 ft)	No	C2	B84143-A36-R105	100 m (328,10 ft)	100 m (328,10 ft)	C2	C2
CFW11 0033 T 2 O FA	100 m (328,10 ft)	No	C2	B84143-A50-R105	100 m (328,10 ft)	100 m (328,10 ft)	C2	C2
CFW11 0045 T 2 O FA	100 m (328,10 ft)	No	C3	B84143-A50-R105	100 m (328,10 ft)	100 m (328,10 ft)	C3	C2
CFW11 0054 T 2 O FA	100 m (328,10 ft)	No	C3	B84143-A66-R105	100 m (328,10 ft)	100 m (328,10 ft)	C3	C2
CFW11 0070 T 2 O FA	100 m (328,10 ft)	No	C3	B84143-A90-R105	100 m (328,10 ft)	100 m (328,10 ft)	C3	C2
CFW11 0086 T 2 O FA	100 m (328,10 ft)	No	C3	B84143-A120-R105	100 m (328,10 ft)	100 m (328,10 ft)	C3	C2
CFW11 0105 T 2 O FA	100 m (328,10 ft)	No	C3	B84143-A120-R105	100 m (328,10 ft)	100 m (328,10 ft)	C3	C2
CFW11 0003 T 4 O FA	100 m (328,10 ft)	5 m (16,40 ft)	C2	B84143-G8-R110	100 m (328,10 ft)	-	C2	C2
				B84143-A8-R105	50 m (164,04 ft)	50 m (164,04 ft)		
CFW11 0005 T 4 O FA	100 m (328,10 ft)	5 m (16,40 ft)	C2	B84143-G8-R110	100 m (328,10 ft)	-	C2	C2
				B84143-A8-R105	50 m (164,04 ft)	50 m (164,04 ft)		
CFW11 0007 T 4 O FA	100 m (328,10 ft)	5 m (16,40 ft)	C2	B84143-G8-R110	100 m (328,10 ft)	-	C2	C2
				B84143-A8-R105	50 m (164,04 ft)	50 m (164,04 ft)		
CFW11 0010 T 4 O FA	100 m (328,10 ft)	5 m (16,40 ft)	C2	B84143-G20-R110	100 m (328,10 ft)	-	C2	C2
				B84143-A16-R105	50 m (164,04 ft)	50 m (164,04 ft)		
CFW11 0013 T 4 O FA	100 m (328,10 ft)	5 m (16,40 ft)	C2	B84143-G20-R110	100 m (328,10 ft)	-	C2	C2
CFW11 0017 T 4 O FA	100 m (328,10 ft)	No	C2	B84143-A25-R105	100 m (328,10 ft)	100 m (328,10 ft)	C2	C2
CFW11 0024 T 4 O FA	100 m (328,10 ft)	No	C2	B84143-A36-R105	100 m (328,10 ft)	100 m (328,10 ft)	C2	C2
CFW11 0031 T 4 O FA	100 m (328,10 ft)	No	C2	B84143-A36-R105	100 m (328,10 ft)	100 m (328,10 ft)	C2	C2
CFW11 0038 T 4 O FA	100 m (328,10 ft)	No	C3	B84143-A50-R105	100 m (328,10 ft)	100 m (328,10 ft)	C3	C2
CFW11 0045 T 4 O FA	100 m (328,10 ft)	No	C3	B84143-A50-R105	100 m (328,10 ft)	100 m (328,10 ft)	C3	C2
CFW11 0058 T 4 O FA	100 m (328,10 ft)	No	C3	B84143-A66-R105	100 m (328,10 ft)	100 m (328,10 ft)	C3	C2
CFW11 0070 T 4 O FA	100 m (328,10 ft)	No	C3	B84143-A90-R105	100 m (328,10 ft)	100 m (328,10 ft)	C3	C2
CFW11 0088 T 4 O FA	100 m (328,10 ft)	No	C3	B84143-A120-R105	100 m (328,10 ft)	100 m (328,10 ft)	C3	C2

Tabella 3: Livelli di emissione convogliata irradiata per i formati da E a G

Modello Azionamento (Filtro RFI integrato)	Telaio	Senza filtro RFI esterno		Con filtro RFI esterno		
		Condotta emissione - massima motore lunghezza cavo	Emissione radiata	RFI esterno codice prodotto filtro - (produttore: EPCOS)	Condotta emissione - massima motore lunghezza cavo	Emissione radiata - senza cabinet metallico
		Categoria C3	Categoria		Categoria C2	Categoria
CFW11 0142 T2		100 m (328,10 ft)	C2	B84143-B0150-S020	100 m (328,10 ft)	C2
CFW11 0180 T2		100 m (328,10 ft)	C2	B84143-B0180-S020 (a)	100 m (328,10 ft)	C2
CFW11 0211 T2		100 m (328,10 ft)	C2	B84143-B0250-S020 (a)	100 m (328,10 ft)	C2
CFW11 0105 T4	E	100 m (328,10 ft)	C2	B84143-B0150-S020	100 m (328,10 ft)	C2
CFW11 0142 T4		100 m (328,10 ft)	C2	B84143-B0150-S020	100 m (328,10 ft)	C2
CFW11 0180 T4		100 m (328,10 ft)	C2	B84143-B0180-S020 (a)	100 m (328,10 ft)	C2
CFW11 0211 T4		100 m (328,10 ft)	C2	B84143-B0250-S020 (a)	100 m (328,10 ft)	C2
CFW11 0242 T4		100 m (328,10 ft)	C3 (a)	B84143-B0250-S021	100 m (328,10 ft) (a)	C3
CFW11 0312 T4		100 m (328,10 ft)	C3 (a)	B84143-B01420-S021	100 m (328,10 ft) (a)	C3
CFW11 0370 T4		100 m (328,10 ft)	C3 (a)	B84143-B0400-S021	100 m (328,10 ft) (a)	C3
CFW11 0477 T4		100 m (328,10 ft)	C3 (a)	B84143-B0600-S021	100 m (328,10 ft) (a)	C3
CFW11 0515 T4		100 m (328,10 ft)	C3 (a)	B84143-B0600-S021	100 m (328,10 ft) (a)	C3
CFW11 0601 T4	G	100 m (328,10 ft)	C3 (a)	B84143-B0600-S021	100 m (328,10 ft) (a)	C3
CFW11 0720 T4		100 m (328,10 ft)	C3 (a)	B84143-B1000-S021	100 m (328,10 ft) (a)	C3

Note per la tabella 3:

- (1) Per temperatura ambientale dell'azionamento/filtro superiore a 40 °C (104 °F) e corrente in uscita continua maggiore di 172 Arms, è necessario utilizzare il filtro B84143B0250S020.
- (2) Per temperatura ambientale dell'azionamento/filtro superiore a 40 °C (104 °F) e applicazioni HD (ciclo di utilizzo gravoso, corrente in uscita < 180 Arms), è possibile utilizzare il filtro B84143B0180S020.
- (3) Con nucleo toroidale sui tre conduttori di rete. Esempio: TDK PN: PC40 UU120x160x20.
- (4) frequenza minima di funzionamento 2,5 Hz.

TASTIERA INTEGRATA – HMI-CFW11



Figura 26: Tasti e funzioni della tastiera



Figura 27: Display della tastiera e esempio delle funzioni di impostazioni di fabbrica (modalità monitoraggio)

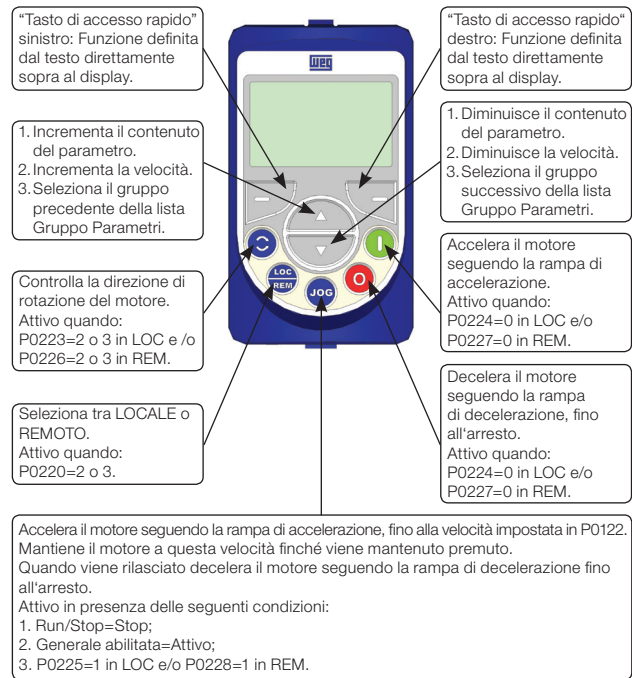

Figura 28: Coperchio batteria tastiera per accesso alla batteria

Note relative alla tastiera:

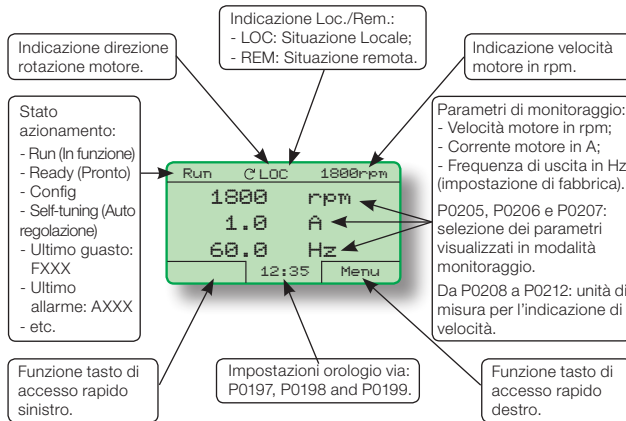
- Collegabile in funzione.
- E' possibile programmare altri tipi di visualizzazioni di monitoraggio, come grafici a barre e dimensioni maggiori dei caratteri, impostando i parametri P0205-207, P0208-212.
- La batteria viene utilizzata solo per mantenere in funzione l'orologio interno quando l'azionamento non è alimentato. Se la batteria si scarica completamente o se non viene installata nella tastiera, l'ora visualizzata non sarà valida e verrà visualizzata una condizione di allarme "A181 - Ora non valida" ad ogni avvio dell'azionamento.
- Al termine dell'utilizzo della batteria, non gettare le batterie nel cestino della spazzatura, ma conferire in una appropriata discarica per batterie.

STRUTTURA DEI PARAMETRI

Quando il tasto di accesso rapido destro ("MENU") viene premuto in modalità monitoraggio, il display mostra i primi gruppi di parametri. Il numero e i nomi dei gruppi può variare in relazione alla versione di firmware utilizzata.

AVVIO

PERICOLO!
L'azionamento subirà danni se l'alimentazione di ingresso viene collegata ai terminali di uscita.

PRIMA DI ALIMENTARE

- 1) Verificare se l'alimentazione, la messa a terra, e la connessioni di controllo sono corrette e ben serrate.
- 2) Rimuovere dall'interno dell'inverter o dall'alloggiamento tutti i materiali relativi al lavoro di installazione.
- 3) Verificare le connessioni del motore e che tensione e corrente siano entro i valori nominali per l'azionamento.
- 4) Disaccoppiare meccanicamente l'inverter dal carico. Se non è possibile disaccoppiare il motore, assicurarsi che quale che sia la direzione di movimento (avanti o indietro) non ne possano risultare lesioni alle persone e/o danni alle apparecchiature.
- 5) Chiudere i coperchi dell'azionamento o degli alloggiamenti.
- 6) Misurare la tensione di alimentazione e verificare che sia entro il campo ammesso.
- 7) Applicare alimentazione all'input chiudendo l'interruttore di sconnessione dell'input.
- 8) Verificare i risultati del primo avvio:
La tastiera dovrebbe visualizzare la modalità standard di alimentazione e il LED indicatore dovrebbe essere illuminato fisso verde.

AVVIO IN MODALITÀ V/F

La procedura di avvio per V/f viene descritta in tre semplici passaggi utilizzando la procedura **Avvio Orientato** e il gruppo **Applicazione di base**.

1) P0000 Impostazione password

Passaggio	Azione/Risultato	Indicazione sul display
1	- Modalità monitoraggio. - Premere "Menu" (tasto di accesso rapido destro).	Ready C LOC 0rpm 0.0 rpm 0.0 A 0.0 Hz 15:45 Menu
2	- Il gruppo "00 ALL PARAMETERS" è già selezionato. - Premere "Select".	Ready C LOC 0rpm 00 ALL PARAMETERS 01 PARAMETER GROUPS 02 ORIENTED START-UP 03 CHANGED PARAMETERS Return 15:45 Select
3	- Il parametro "Access to Parameters P0000: 0" è già selezionato. - Premere "Select".	Ready C LOC 0rpm Access to Parameters P0000: 0 Speed Reference P0001: 90 rpm Return 15:45 Select
4	- Per impostare la password, premere fino a visualizzare il numero 5 sul display.	Ready C LOC 0rpm P0000 Access to Parameters 0 Return 15:45 Save
5	- Quando compare il numero 5, premere "Save".	Ready C LOC 0rpm P0000 Access to Parameters 5 Return 15:45 Save
6	- Se l'impostazione è stata eseguita correttamente, il display deve visualizzare "Access to Parameters P0000: 5". - Premere "Return" (tasto di accesso rapido sinistro).	Ready C LOC 0rpm Access to Parameters P0000: 5 Speed Reference P0001: 90 rpm Return 15:45 Select
7	- Premere "Return".	Ready C LOC 0rpm 00 ALL PARAMETERS 01 PARAMETER GROUPS 02 ORIENTED START-UP 03 CHANGED PARAMETERS Return 15:45 Select
8	- Il display torna in modalità monitoraggio.	Ready C LOC 0rpm 0 rpm 0.0 A 0.0 Hz 15:45 Menu

Figura 29: Passaggi per consentire la modifica dei parametri tramite P0000

2) Avvio orientato

Esiste un gruppo di parametri chiamato "Avvio Orientato", che rende più facile l'impostazione dell'inverter. Il parametro P0317 di questo gruppo consente di avviare la procedura di Avvio Orientato.

La procedura di Avvio Orientato presenta i parametri principali sull'HMI in una sequenza logica. Vengono regolati esclusivamente i parametri necessari al corretto funzionamento. Vengono inserite informazioni come la tensione di rete e dati della targhetta del motore.

Per iniziare la procedura di Avvio Orientato, occorre prima impostare il parametro P0317 a 1 e poi, impostare tutti i restanti parametri, man mano che vengono presentati sul display.

L'impostazione dei parametri nella procedura Avvio Orientato determina la modifica automatica del contenuto di altri parametri e/o variabili interne dell'azionamento.

Nel corso della procedura Avvio Orientato viene visualizzato il messaggio "Config" nell'angolo superiore sinistro del display dell'HDI.

3) Impostazione parametri applicativi di base

Dopo aver eseguito la procedura di Avvio Orientato e aver correttamente impostato i parametri, l'azionamento può operare in modalità V/f.

Il gruppo Basic Application contiene i parametri applicativi più comuni.

IMPOSTAZIONE DI DATA E ORARIO

Accedere al gruppo HMI e modificare: giorno (P0194), mese (P0195) e anno (P0196); orario: ora (P0197), minuti (P0198) e secondi (P0199).

PREVENZIONE DI CAMBIAMENTO DI PASSWORD

Per impedire il cambiamento non autorizzato o per errore, è possibile impostare il parametro P0000 ad un valore differente da 5.

FUNZIONI DEL MODULO DI MEMORIA FLASH

- Memorizzare una copia dei parametri dell'azionamento.
- Trasferire all'inverter parametri memorizzati nella memoria FLASH.
- Trasferire all'inverter firmware memorizzato nella memoria FLASH.
- Memorizzare il programma creato con SoftPLC.

Ogni volta che viene avviato l'azionamento, questo programma (SoftPLC) viene trasferito nella memoria RAM che si trova nella scheda di controllo dell'azionamento, ed eseguito.

Fare riferimento al manuale di programmazione CFW-11 e al manuale SoftPLC per ulteriori dettagli.

APPENDICE 1 – SPECIFICHE TECNICHE
Tabella A.1: Specifiche tecniche dei formati da A ad D

Modello	Telaio	Numero di fasi dell'alimentazione	Uso con ciclo di utilizzo normale (ND)							Uso con ciclo di utilizzo intensivo (HD)							Fusibile I ² t [A ² s] @ 25 °C	Fusibile [A] conforme allo standard europeo IEC	Temperatura ambientale [°C (°F)]	Frenatura dinamica	Disponibilità dei kit opzionali incorporabili nel prodotto												
			Corrente nominale in uscita [Arms]	Corrente sovraccarico [Arms]		Frequenza nominale portante [kHz]	Motore massimo [HP/kW]	Corrente nominale in ingresso [Arms]	Potenza dissipata [W]		Corrente nominale in ingresso [Arms]	Corrente sovraccarico [Arms]		Frequenza nominale portante [kHz]	Motore massimo [HP/kW]	Corrente nominale in uscita [Arms]					Potenza dissipata [W]		Cabinet	Filtro RFI	Arresto di sicurezza	Alimentatore a controllo esterno 24 V CC							
1 min	3 s	1 min		3 s	Montaggio su superficie				Montaggio con flangia	1 min		3 s	1 min				3 s	Montaggio su superficie	Montaggio con flangia	Si	Incorporato	Si					Incorporato						
CFW11 0006 B 2	A	1ø / 3ø	6	6,6	9	5	1,5/1,1	12,3/6	5	7,5	10	5	1,5/1,1	10,3/5	5	5,7/12,6	15	420	-10... 50 °C (14...122)	Incorporato													
CFW11 0006 S 2 OFA		1ø	6	6,6	9	5	1,5/1,1	12,3	5	7,5	10	5	1,5/1,1	10,3	5	5,7/12,6	15	420	-10... 50 °C (14...122)	Incorporato													
CFW11 0007 T 2		3ø	7	7,7	10,5	5	2/1,5	7	5,5	8,25	11	5	1,5/1,1	5,5	120	5,7/12,6	15	420	-10... 50 °C (14...122)	Incorporato													
CFW11 0007 B 2		1ø / 3ø	7	7,7	10,5	5	2/1,5	14,4/7	7	10,5	14	5	2/1,5	14,4/7	140	6,1/13,4	420			-10... 50 °C (14...122)	Incorporato	Nema 1 (kit condotti per telaio A)											
CFW11 0007 S 2 OFA		1ø	7	7,7	10,5	5	2/1,5	14,4	7	10,5	14	5	2/1,5	14,4	140	6,1/13,4	15	420	-10... 50 °C (14...122)	Incorporato	Nema 1 (kit condotti per telaio A)												
CFW11 0010 T 2		3ø	10	11	15	5	3/2,2	10	8	12	16	5	2/1,5	8	170	5,7/12,6	15	420	-10... 50 °C (14...122)	Incorporato	Nema 1 (kit condotti per telaio A)												
CFW11 0010 S 2		1ø	10	11	15	5	3/2,2	20,5	10	15	20	5	3/2,2	20,5	140	6,1/13,4	25	1000	-10... 50 °C (14...122)	Incorporato	Nema 1 (kit condotti per telaio A)												
CFW11 0013 T 2		3ø	13	14,3	19,5	5	4/3,0	13	11	16,5	22	5	3/2,2	11	170	6,1/13,4	20	420	-10... 50 °C (14...122)	Incorporato	Nema 1 (kit condotti per telaio A)												
CFW11 0016 T 2		3ø	16	17,6	24	5	5/3,7	16	13	19,5	26	5	4/3,0	13	190	6,3/13,9	25	420	-10... 50 °C (14...122)	Incorporato	Nema 1 (kit condotti per telaio A)												
CFW11 0024 T 2		3ø	24	26,4	36	5	7,5/5,5	24	20	30	40	5	6/4,5	20	250	9,1/20	25	1000	-10... 50 °C (14...122)	Incorporato	Nema 1 (kit condotti per telaio A)												
CFW11 0028 T 2		3ø	28	30,8	42	5	10/7,5	28	24	36	48	5	7,5/5,5	24	290	9,1/20	35	1000	-10... 50 °C (14...122)	Incorporato	Nema 1 (kit condotti per telaio B)												
CFW11 0033 T 2		3ø	33,5	36,9	50,3	5	12,5/9,2	33,5	30	42	56	5	10/7,5	28	350	9,1/20	30	1000	-10... 50 °C (14...122)	Incorporato	Nema 1 (kit condotti per telaio B)												
CFW11 0045 T 2		3ø	45	49,5	67,5	5	15/11	45	36	54	72	5	12,5/9,2	36	450	15,6/34,4	50	2750	-10... 50 °C (14...122)	Incorporato	Nema 1 (kit condotti per telaio B)												
CFW11 0054 T 2		3ø	54	59,4	81	5	20/15	54	45	67,5	90	5	15/11	45	540	16,0/35,3	70	2750	-10... 50 °C (14...122)	Incorporato	Nema 1 (kit condotti per telaio B)												
CFW11 0070 T 2	3ø	70	77	105	5	25/18,5	70	56	84	112	5	20/15	56	680	17,9/39,5	80	2750	-10... 50 °C (14...122)	Incorporato	Nema 1 (kit condotti per telaio B)													
CFW11 0086 T 2	3ø	86	94,6	129	5	30/22	86	70	105	140	5	25/18,5	70	740	19,5/65,1	100	3150	-10... 50 °C (14...122)	Incorporato	Nema 1 (kit condotti per telaio B)													
CFW11 0105 T 2	3ø	105	116	158	5	40/30	105	86	129	172	5	30/22	86	920	31,4/69,2	125	3150	-10... 50 °C (14...122)	Incorporato	Nema 1 (kit condotti per telaio B)													
CFW11 0003 T 4	D	3ø	3,6	3,96	5,40	5	2/1,5	3,6	5	7,5	10	5	2/1,5	3,6	110	25	190	-10... 50 °C (14...122)	Incorporato	Nema 1 (kit condotti per telaio A)													
CFW11 0005 T 4		3ø	5	5,5	7,5	5	3/2,2	5	140	25	5	3/2,2	5	140	25	5,9/13	15	190	-10... 50 °C (14...122)	Incorporato	Nema 1 (kit condotti per telaio A)												
CFW11 0007 T 4		3ø	7	7,7	10,5	5	4/3	7	180	30	5,5	8,25	11	5	140	25	190	-10... 50 °C (14...122)	Incorporato	Nema 1 (kit condotti per telaio A)													
CFW11 0010 T 4		3ø	10	11	15	5	6/4,5	10	220	30	10	15	20	5	140	25	190	-10... 50 °C (14...122)	Incorporato	Nema 1 (kit condotti per telaio A)													
CFW11 0013 T 4		3ø	13,5	14,9	20,3	5	7,5/5,5	13,5	280	40	11	16,5	22	5	200	30	495	-10... 50 °C (14...122)	Incorporato	Nema 1 (kit condotti per telaio A)													
CFW11 0017 T 4		3ø	17	18,7	25,5	5	10/7,5	17	360	50	13,5	20,3	27	5	220	30	495	-10... 50 °C (14...122)	Incorporato	Nema 1 (kit condotti per telaio A)													
CFW11 0024 T 4		3ø	24	26,4	36	5	15/11	24	490	70	19	28,5	38	5	270	40	495	-10... 50 °C (14...122)	Incorporato	Nema 1 (kit condotti per telaio A)													
CFW11 0031 T 4	3ø	31	34,1	46,5	5	20/15	31	560	80	25	37,5	50	5	360	50	500	-10... 50 °C (14...122)	Incorporato	Nema 1 (kit condotti per telaio A)														
CFW11 0038 T 4	3ø	38	41,8	57	5	25/18,5	38	710	110	33	49,5	66	5	430	60	1250	-10... 50 °C (14...122)	Incorporato	Nema 1 (kit condotti per telaio A)														
CFW11 0045 T 4	3ø	45	49,5	67,5	5	30/22	45	810	120	38	57	76	5	430	60	1250	-10... 50 °C (14...122)	Incorporato	Nema 1 (kit condotti per telaio A)														
CFW11 0058 T 4	3ø	58,5	64,4	87,8	5	40/30	58,5	1050	160	47	70,5	94	5	430	60	1250	-10... 50 °C (14...122)	Incorporato	Nema 1 (kit condotti per telaio A)														
CFW11 0070 T 4	3ø	70,5	77,6	106	5	50/37	70,5	1280	190	61	91,5	122	5	430	60	1250	-10... 50 °C (14...122)	Incorporato	Nema 1 (kit condotti per telaio A)														
CFW11 0088 T 4	3ø	88	96,8	132	5	60/45	88	1480	220	73	110	146	5	430	60	1250	-10... 50 °C (14...122)	Incorporato	Nema 1 (kit condotti per telaio A)														

Modelli con 200... Alimentazione 240 V

Modelli con 380... Alimentazione 480 V

Tabella A.2: Specifiche tecniche dei formati da E a G

Modello	Numero di fasi dell'alimentazione		Uso con ciclo di utilizzo normale (ND)						Uso con ciclo di utilizzo intensivo (HD)						Peso [kg (lb)]	Fusibile [A] conforme allo standard europeo IEC	Fusibile I ² t [A ² s] @ 25 °C	Temperatura ambientale [°C (°F)]	Frenatura dinamica	Disponibilità dei kit opzionali incorporabili nel prodotto				
	Telaio		Corrente in uscita nominale ⁽¹⁾ [Arms]	Corrente sovraccarico ⁽²⁾ [Arms]	1 min	3 s	Frequenza nominale portante [kHz]	Motore massimo [HP/kW]	Corrente nominale in ingresso [Arms]	Potenza dissipata [W]	Montaggio con flangia	Montaggio su superficie	Corrente nominale in ingresso [Arms]	Corrente sovraccarico ⁽²⁾ [Arms]							1 min	3 s	Frequenza nominale portante [kHz]	Motore massimo [HP/kW]
CFW11 0142 T 2	3ø	3ø	142	156,2	213	213	2,5	50/37	142	1490	210	115	172,5	230	5	40/30	115	1280	200	64,0 (141,1)	200	-10... 45 (14... 113)	Opzionale (il prodotto standard non include la funzione di frenatura dinamica)	Sì
CFW11 0180 T 2	3ø	3ø	180	198	270	270	2,5	60/45	180	1820	360	142	213	284	5	50/37	142	1550	350	65,0 (143,3)	200	-10... 45 (14... 113)	Opzionale (il prodotto standard non include la funzione di frenatura dinamica)	Sì
CFW11 0211 T 2	3ø	3ø	211	232	317	317	2,5	75/55	211	2040	360	180	270	360	2,5	75/55	180	1690	350	65,0 (143,3)	250	-10... 45 (14... 113)	Incorporato	Sì
CFW11 0105 T 4	3ø	3ø	105	115,5	157,5	157,5	2,5	75/55	105	1270	200	88	132	176	2,5	60/45	88	1020	190	62,5 (137,8)	125	-10... 45 (14... 113)	Incorporato	Sì
CFW11 0142 T 4	3ø	3ø	142	156,2	213	213	2,5	100/75	142	1680	210	115	172,5	230	2,5	75/55	115	1290	200	64,0 (141,1)	200	-10... 45 (14... 113)	Non incluso	Sì
CFW11 0180 T 4	3ø	3ø	180	198	270	270	2,5	150/110	180	2050	360	142	213	284	2,5	100/75	142	1570	350	65,0 (143,3)	200	-10... 45 (14... 113)	Non incluso	Sì
CFW11 0211 T 4	3ø	3ø	211	232,1	317	317	2,5	175/132	211	2330	360	180	270	360	2,5	150/110	180	1940	350	65,0 (143,3)	250	-10... 45 (14... 113)	Non incluso	Sì
CFW11 0242 T 4	3ø	3ø	242	266	363	363	2,5	200/150	242	1518	285	211	317	422	2,5	175/132	211	1277	227	130 (286,6)	315	-10... 45 (14... 113)	Non incluso	Sì
CFW11 0312 T 4	3ø	3ø	312	343	468	468	2,5	250/185	312	2034	375	242	363	484	2,5	200/150	242	1507	292	132 (291,0)	500	-10... 45 (14... 113)	Non incluso	Sì
CFW11 0370 T 4	3ø	3ø	370	407	555	555	2,5	300/220	370	2497	407	312	468	624	2,5	250/185	312	2008	320	135 (297,6)	500	-10... 45 (14... 113)	Non incluso	Sì
CFW11 0477 T 4	3ø	3ø	477	525	716	716	2,5	400/300	477	3273	595	370	555	740	2,5	300/220	370	2451	465	140 (308,6)	700	-10... 45 (14... 113)	Non incluso	Sì
CFW11 0515 T 4	3ø	3ø	515	567	773	773	2	400/300	515	3338	769	477	716	954	2	400/300	477	2987	644	204 (449,7)	900	-10... 45 (14... 113)	Non incluso	Sì
CFW11 0601 T 4	3ø	3ø	601	662	900	900	2	500/370	601	3875	781	515	773	1030	2	400/300	515	3219	639	207 (456,4)	900	-10... 45 (14... 113)	Non incluso	Sì
CFW11 0720 T 4	3ø	3ø	720	792	1080	1080	2	600/440	720	4576	858	560	840	1120	2	450/330	560	3747	653	215 (474,0)	1100	-10... 40 (14... 104)	Non incluso	Sì

Note:
 (1) Corrente nominale costante alle seguenti condizioni:
 - Frequenze di commutazione specificate.
 - Temperatura aria circostante come specificato in tabella. Per temperature maggiori, limitata a 10 °C sopra alla temperatura massima specificata per le condizioni nominali, la corrente in uscita deve essere ridotta del 2 % per ogni °C eccedente la temperatura massima specificata.

(2) La potenza specificata per i motori è puramente indicativa per i motori WEG 230 V o 460 V, IV poli. Il dimensionamento adeguato dell'inverter deve essere basato sulla corrente nominale del motore utilizzato.

Umidità relativa aria: da 5 % a 90 % non-condensante.
 - Altitudine: 1000 m (3.300 ft). Sopra 1000 m (3.300 ft) la corrente in uscita va decrementata dell'1 % per ogni 100 m (328:10 ft) sopra 1000 m (3.300 ft).
 - Ambiente con emissioni grado 2 (in accordo con EN50178 e UL508C).

Tabella A.3: Specifiche della frenatura dinamica dei formati da A ad E

Modello Azionamento	Corrente max. frenatura (I_{max}) [A]	Potenza max. frenatura (valore di picco) (P_{max}) ⁽²⁾ [kW]	Corrente eff. frenatura (I_{eff}) ⁽¹⁾ [A]	Potenza dissipata (valore medio) nella resistenza di frenatura (P_R) ⁽²⁾ [kW]	Resistenza consigliata [Ω]	Sezione cavi alimentazione (terminali DC+ e BR) [mm ² (AWG)]
CFW11 0006 B 2	5,3	2,1	5,2	2,03	75	1,5 (16)
CFW11 0006 S 2 O FA	5,3	2,1	5,2	2,03	75	1,5 (16)
CFW11 0007 B 2	7,1	2,9	6,96	2,71	56	1,5 (16)
CFW11 0007 S 2 O FA	7,1	2,9	6,96	2,71	56	1,5 (16)
CFW11 0007 T 2	5,3	2,1	5,2	2,03	75	1,5 (16)
CFW11 0010 S 2	11,1	4,4	10,83	4,22	36	2,5 (14)
CFW11 0010 T 2	7,1	2,9	6,96	2,71	56	1,5 (16)
CFW11 0013 T 2	11,1	4,4	8,54	2,62	36	2,5 (14)
CFW11 0016 T 2	14,8	5,9	14,44	5,63	27	4 (12)
CFW11 0024 T 2	26,7	10,7	19,15	5,5	15	6 (10)
CFW11 0028 T 2	26,7	10,7	18,21	4,97	15	6 (10)
CFW11 0033 T 2	26,7	10,7	16,71	4,19	15	6 (10)
CFW11 0045 T 2	44	17,6	33,29	10,1	9,1	10 (8)
CFW11 0054 T 2	48,8	19,5	32,17	8,49	8,2	10 (8)
CFW11 0070 T 2	48,8	19,5	26,13	5,6	8,2	6 (8)
CFW11 0086 T 2	93	37,2	90,67	35,3	4,3	35 (2)
CFW11 0105 T 2	111,1	44,4	90,87	29,7	3,6	35 (2)
CFW11 0003 T 4	3,6	2,9	3,54	2,76	220	1,5 (16)
CFW11 0005 T 4	5,3	4,3	5,2	4,05	150	1,5 (16)
CFW11 0007 T 4	5,3	4,3	5,2	4,05	150	1,5 (16)
CFW11 0010 T 4	8,8	7	8,57	6,68	91	2,5 (14)
CFW11 0013 T 4	10,7	8,5	10,4	8,11	75	2,5 (14)
CFW11 0017 T 4	12,9	10,3	12,58	9,81	62	2,5 (12)
CFW11 0024 T 4	17	13,6	16,59	12,9	47	4 (10)
CFW11 0031 T 4	26,7	21,3	20,49	12,6	30	6 (10)
CFW11 0038 T 4	36,4	29,1	26,06	14,9	22	6 (8)
CFW11 0045 T 4	47,1	37,6	40	27,2	17	10 (8)
CFW11 0058 T 4	53,3	42,7	31,71	15,1	15	10 (8)
CFW11 0070 T 4	66,7	53,3	42,87	22,1	12	10 (6)
CFW11 0088 T 4	87,9	70,3	63,08	36,2	9,1	25 (4)
CFW11 0142 T 2 O DB	266,7	106,7	142	30,2	1,5	70 (2/0) o 2x 25 (2x 4)
CFW11 0180 T 2 O DB	266,7	106,7	180	48,6	1,5	120 (4/0) o 2x 35 (2x 2)
CFW11 0211 T 2 O DB	333,3	133,3	211	53,4	1,2	150 (300) o 2x 50 (2x 1)
CFW11 0105 T 4 O DB	186	148,8	105	47,4	4,3	50 (1)
CFW11 0142 T 4 O DB	266,7	213,3	142	60,5	3	70 (2/0) o 2x 25 (2x 4)
CFW11 0180 T 4 O DB	266,7	213,3	180	97,2	3	120 (4/0) o 2x 35 (2x 2)
CFW11 0211 T 4 O DB	363,6	290,9	191,7	80,8	2,2	120 (250) o 2x 50 (2x 1)

Note:

(1) L'effettiva corrente di frenatura è solo un valore indicativo in quanto dipendente dal ciclo di utilizzo della frenatura. L'effettiva corrente di frenatura può essere ottenuta dalla seguente equazione, dove t_{br} è espresso in minuti e corrisponde alla somma di tutti i tempi di frenatura durante il ciclo più intenso di 5 (cinque) minuti.

$$I_{effettiva} = I_{max} \cdot \sqrt{\frac{t_{br}}{5}}$$

(2) I valori P_{max} e P_R (rispettivamente potenza massima e media della resistenza di frenatura) presentati sono validi per le resistenze consigliate e per le correnti di frenatura effettive presentate nella tabella. La potenza della resistenza deve essere cambiata in relazione al ciclo di utilizzo.



WEG Drives & Controls - Automação LTDA.
Jaraguá do Sul - SC - Brazil
Phone 55 (47) 3276-4000 - Fax 55 (47) 3276-4020
São Paulo - SP - Brazil
Phone 55 (11) 5053-2300 - Fax 55 (11) 5052-4212
automacao@weg.net
www.weg.net



12101417