

Preface

Thank you for purchasing EM303B series inverter.

Document No.: 31010032

Version No.:104

Issue Date: 11/2015

EM303B is a general purpose vector control inverter. An induction motor with the help of EM303B can possess fast speed response and torque control ability as a DC motor which makes the motion control system stable, precise, and quick.

Main Features:

1. SVC (Sensorless vector control): Torque control accuracy: 5% rated torque. Speed control accuracy: $\pm 0.2\%$ rated synchronous speed.
2. VVF (Vector decoupling based VF control): The steady performance is the same as that in SVC.
3. Wide speed regulation range, load capacity at low frequency: SVC/0.5Hz/150% rated load, VVF/1.0Hz/150% rated load.
4. Optimized current and voltage protection algorithm ensures that motor can accelerate/decelerate in 0.1S.
5. AVR function makes output voltage stable at grid voltage fluctuation.
6. Load disturbance compensation ensures failure-free operation of motor.
7. Auto-searching motor speed at restart smoothes the start of motor without current over-shoot.
8. 2 acceleration/deceleration modes: linear and S curve.
9. The performance and stability are improved significantly with dual-CPU.

It is the duty of any user to perform the appropriate, correct installation or configuration of the optional parameters of the devices. Neither SINEE nor its distributors shall be responsible or liable for misuse of the information contained herein or mismatching the inverter with the motor.

In the interests of commitment to a policy of continuous development and improvement, SINEE reserves the right to update the specification of the product or its performance, or the content herein without notice.

Contents

PREFACE	1
CONTENTS	2
SAFETY INFORMATION	4
SAFETY PRECAUTIONS	4
1 OVERVIEW	8
1.1 EM303B MODEL LIST AND TECHNICAL SPECIFICATIONS	8
1.2 DEFINITION OF EM303B OPERATION STATUS	10
1.3 EM303B OUTLOOK	13
2 INSTALLATION	14
2.1 VERIFYING PRODUCT	14
2.2 OVERALL AND INSTALLATION DIMENSIONS	15
2.3 CONSIDERATIONS OF INSTALLATION SITE	17
2.4 DIRECTION AND SPACE OF INSTALLATION	17
2.5 DISASSEMBLY AND ASSEMBLY OF KEYPAD	19
2.6 FLUSH MOUNTING	21
3 WIRING	22
3.1 CONNECTIONS TO PERIPHERALS	22
3.2 WIRING MAIN CIRCUIT TERMINALS	23
3.3 WIRING CONTROL CIRCUIT TERMINALS	31
3.4 EXTENDING KEYPAD WIRE	39
3.5 WIRING CHECK	40
4 KEYPAD OPERATION	41
4.1 TYPE AND FUNCTION OF KEYPAD	41
4.2 LED KEYPAD OPERATION MODE	42
5 TRIAL OPERATION	49
5.1 TRIAL OPERATION PROCEDURES	49
5.2 TRIAL OPERATION PRECAUTIONS	50
6 PARAMETER TABLE	52
6.1 FORMAT OF PARAMETER TABLES	52
6.2 PARAMETER TABLE	52
SECTION 1 GENERAL PARAMETERS	52
SECTION 2 ADVANCED PARAMETERS	66
7 PARAMETER DESCRIPTION	81
SECTION 1 GENERAL PARAMETERS	81
7.1 F0 GROUP: GENERAL PARAMETERS	81
7.2 F1 GROUP: MOTOR PARAMETERS	92
7.3 F2 GROUP: INPUT/OUTPUT TERMINAL PARAMETERS	95
7.4 F3 GROUP: PRESET SPEED OPERATION PARAMETERS	105
7.5 F4 GROUP: GENERAL PARAMETERS OF PID	110
7.6 F5 GROUP: GENERAL PARAMETERS OF VECTOR CONTROL	116
7.7 C0 GROUP: PARAMETERS OF MONITORING FUNCTION	121

SECTION 2 ADVANCED PARAMETERS	122
7.8 F6 GROUP: SIMPLE PLC FUNCTION.	122
7.9 F7 GROUP: ADVANCED PARAMETERS OF OPERATION	128
7.10 F8 GROUP: INPUT/OUTPUT BIAS	133
7.11 F9 GROUP: SPEED SETTING OPTIONS.	137
7.12 FA GROUP: ADVANCED PARAMETERS OF VECTOR CONTROL	145
7.13 FC GROUP: PARAMETERS OF OPERATION CONTROL.	146
7.14 Fd GROUP: AUXILIARY PARAMETERS	155
7.15 FE GROUP: USER DEFINED TERMINAL FUNCTION PARAMETERS	158
8AUTOTUNING MOTOR PARAMETERS	162
8.1 AUTOTUNING MOTOR PARAMETERS	162
8.2 PRECAUTIONS BEFORE AUTOTUNING	162
8.3 AUTOTUNING PROCEDURE	163
9TROUBLESHOOTING	164
9.1 FAULTS	164
REFERENCE OF LED CHARACTERS	166
9.2 FAULT ANALYSIS.	167
10MAINTENANCE AND INSPECTION	170
10.1 MAINTENANCE AND INSPECTION	170
10.2 DAILY INSPECTION	170
10.3 PERIODIC MAINTENANCE	170
10.4 PERIODIC MAINTENANCE AND REPLACEMENT OF PARTS	171
10.5 OUTLINE OF WARRANTY	171
11ACCESSORIES	172
11.1 KEYPAD EXTENSION WIRE	172
11.2 REMOTE CONTROL CASE.	172
11.3 BRAKING RESISTOR	173
11.4 BRAKING UNIT	174
11.5 CONNECTING CABLE.	174
11.6 CHASSIS FOR FLOOR MOUNTING	174
11.7 EXTENDED COPPER BAR	176
12MODBUS COMMUNICATION PROTOCOL.	177
12.1 APPLICATION SCOPE	177
12.2 PHYSICAL INTERFACE	177
12.3 PROTOCOL FORMAT	177
12.4 EXPLANATION OF COMMAND	177
12.5 DESCRIPTION OF PROTOCOL FORMAT	179
12.6 DESCRIPTION OF CONTROL COMMAND	182
12.7 EXAMPLE	183
12.8 TROUBLESHOOTING OF COMMON COMMUNICATION	184

Safety Information



Danger: The addition of this symbol to a Danger or Warning safety label indicates that an electrical hazard exists, which will result in personal injury if the instructions are not followed.



Caution: This is the safety alert symbol. It is used to alert you to potential personal injury hazards. Obey all safety messages that follow this symbol to avoid possible injury or a risk of damage to the products or other devices.

Safety Precautions

Before Installation



Danger

1. Do not install the product if the package is with water, or component is missing or broken.
2. Do not install the product if the label on the package is not identical to that on the inverter.



Danger

1. Be careful of carrying or transportation. Risk of devices damage.
2. Do not use damaged product or the inverters missing component. Risk of injury.
3. Do not touch the parts of control system with bare hands. Risk of ESD hazard.

Installation:



Danger

1. Installation base shall be metal or other non-flammable material. Risk of fire.
2. Do not unscrew the fixing bolts, especially the bolts with red mark.



Caution

1. Do not leave cable strips or screws in the inverter. Risk of inverter damage.
2. Install the product at the place with less vibration and no direct sunlight.
3. Consider the installation space for cooling purpose when the inverter is installed in a cabinet.

Wiring:



1. Wiring must be performed by authorized and qualified personnel. Risk of danger.
2. Circuit-breaker should be installed between inverter and the mains. Risk of fire.
3. Be sure that the power supply is off before wiring, and ground inverter as per standard wiring. Risk of electrical hazard.
4. Grounding terminal must be grounded. Risk of electrical hazard and fire.
5. Dual keypad is not recommended. Risk of unexpected danger.



1. Never connect input power supply cable to output terminals U, V, and W of inverter. Pay attention to the terminal symbols, connect them correctly. Risk of inverter damage.
2. Be sure that the wiring meets EMC requirements and local safety standard. Cables should be in recommended sizes. Risk of accident.
3. Do not connect braking resistor to DC bus terminal + & -. Risk of fire.
4. Tighten terminals with screw drivers of specified torque. Risk of fire.
5. Do not connect phase-shifting capacitor and LC/RC noise filter to output circuits.
6. Do not connect the solenoid switch and electromagnetic contactor to output circuits. Otherwise, it will trigger overcurrent protection, or damage inverter.
7. Do not disconnect internal wires of inverter. Risk of inverter damage.

Before Power-on



1. Verify that the input voltage is identical to the rated voltage of product, correct wiring of input terminals R, S, and T and output terminals U, V, and W, wiring of inverter and its peripheral circuits, and all wires should be in good connection. Risk of inverter damage.
2. Never perform voltage withstanding test on inverter, it has been done at ex-works. Risk of accident.



1. Inverter shall be power-on only after the front cover is assembled. Risk of electrical hazard.
2. Wiring of all peripherals should abide by the guide of this manual. Risk of accident.

After Power-on



1. Do not touch the inverter and its peripheral circuits with wet hands. Risk of electrical hazard.
2. Do not touch any input/output terminals of inverter with bare hands. Risk of electrical hazard.
3. After power is on at the first time, inverter will detect external circuit automatically. Meanwhile, do not touch wiring terminals U, V, and W of inverter, or wiring terminal of motor with bare hands. Risk of electrical hazard.



1. If autotuning is required, be careful of personal injury when motor is running. Risk of accident.
2. Do not change the defaults of parameters. Risk of device damage.

Trial Operation



1. Only after the front cover is installed, power can be turned on. Never take off the front cover when power is on.
An electric shock may occur.
2. Do not come close to the machine at power failure if fault reset function is active. The inverter will restart automatically when power is on.
An injury may occur.
3. Install an emergency stop for a quick brake in case of abnormal conditions. ( is only enabled in keypad control mode.)
An injury may occur.



1. Never touch braking resistor. It will be very hot and with high-voltage when running. Otherwise, an electric shock and a burn injury may occur.
2. Reconfirm the motor and machine are within the applicable ranges before starting operation. Otherwise, an injury may occur.
3. Do not check signals while the inverter is running. Otherwise, the inverter will be damaged.
4. Be careful when editing inverter settings. The inverter is in factory default. Otherwise, the inverter will be damaged.

During Operation



1. Do not touch cooling fans, heat sink, metal panel, or discharge resistor with bare hands. Risk of burning.
2. Non-professionals shall not detect signals during operation. Risk of personal injury or device damage.



1. Prevent any foreign items from being left in the devices during operation. Risk of device damage.
2. Do not control start/stop of inverter by ON/OFF of contactor. Risk of device damage.

Maintenance



1. Maintain and inspect devices after power is off. Risk of electric hazard.
2. Maintain and inspect inverter only after the voltage is lower than DC 36V between DC bus terminals + & -, and power is off for 5 minutes. The residual charge on capacitor may cause personal injury.
3. Maintenance and inspection can only be performed by professionals. Risk of personal injury.
4. Parameter setting is required if inverter has been replaced. Plug-in & plug-out should be performed after power-off.

1 Overview

1.1 EM303B Model List and Technical Specifications

- Rated voltage: 3-phase, 380VAC
- Applicable motor: 3-phase induction motor, power range: 0.75~400kW.
- Output voltage: 3-phase, from 0 to U_{supply} .

1.1.1 EM303B Model and Rated Output Current

Table 1-1 Model List of EM303B

Rated Voltage	Model No.	Motor Power(kW)	Rated Output Current(A)
3-phase, 380VAC ±20%	EM303B-0R7G/1R1P-3B	0.75/1.1	2.8/3.7
	EM303B-1R1G/1R5P-3B	1.1/1.5	3.7/4.8
	EM303B-1R5G/2R2P-3B	1.5/2.2	4.8/6.2
	EM303B-2R2G/3R0P-3B	2.2/3.0	6.2/8.0
	EM303B-3R0G/4R0P-3B	3.0/4.0	8.0/10.0
	EM303B-4R0G/5R5P-3B	4.0/5.5	10.0/13
	EM303B-5R5G/7R5P-3B	5.5/7.5	13/17
	EM303B-7R5G/9R0P-3B	7.5/9.0	17/20
	EM303B-9R0G/011P-3B	9.0/11	20/26
	EM303B-011G/015P-3B	11/15	26/34
	EM303B-015G/018P-3B	15/18.5	34/41
	EM303B-018G/022P-3	18.5/22	41/48
	EM303B-022G/030P-3	22/30	48/60
	EM303B-030G/037P-3	30/37	60/75
	EM303B-037G/045P-3	37/45	75/90
	EM303B-045G/055P-3	45/55	90/115
	EM303B-055G/075P-3	55/75	115/150
	EM303B-075G/090P-3	75/90	150/180
	EM303B-090G/110P-3	90/110	180/220
	EM303B-110G/132P-3	110/132	220/265
	EM303B-132G/160P-3	132/160	265/310
	EM303B-160G/185P-3	160/185	310/360
	EM303B-185G/200P-3	185/200	360/380
	EM303B-200G/220P-3	200/220	380/420
EM303B-220G/250P-3	220/250	420/470	
EM303B-250G/280P-3	250/280	470/530	
EM303B-280G/315P-3	280/315	530/600	
EM303B-315G/355P-3	315/355	600/660	
EM303B-355G/400P-3	355/400	660/740	
EM303B-400G/450P-3	400/450	740/820	

Remarks:

EM303B is an integrated model with G (fixed torque) and P (square torque) in one. The data listed above is of Model G. When applied to square torque like blower, water pump and etc., the power ratings of applicable motor can be one grade higher. See inverter's nameplate for details.

1.1.2 EM303B Technical Specifications

Table 1-2 EM303B Technical specifications

Items		Specifications
Input	Rated Voltage	3-phase 380VAC±20%, 50~60Hz±5%, voltage imbalance rate <3%
Output	Output Voltage	3-phase, from 0 to U _{supply} .
	Rated Output Current	100% rated current non-stop output
	Max. Overload Current	Model G: 150% rated current for 1 minutes, 180% rated current for 10 seconds Model P: 120% rated current for 1 minutes, 150% rated current for 10 seconds
Basic Control Functions	Control Mode	V/F, SVC0, SVC1
	Input Mode	Frequency (Speed) input, torque input
	Start/Stop Control Mode	Keypad, control terminals (2-wire sequence, 3-wire sequence), RS485
	Frequency Control Range	0.00~600.00Hz
	Input Frequency Resolution	Numeric input: 0.01Hz, analog input: 0.1% of maximum frequency
	Governor Deflection	1:50(V/F), 1:100(SVC)
	Speed Control Accuracy	±0.2% rated synchronous speed
	Acceleration/Deceleration Time	0.01~600.00 seconds/minutes
	V/F Features	Rated output voltage: 20%~100% adjustable Frequency base :20Hz~600Hz adjustable
	Torque Boost	Automatic torque boost, fixed torque boost curve, customer defined V/F curve scaling
	Start Torque	150%/1Hz(V/F),150%/0.5Hz(SVC)
	Torque Control Accuracy	±5% rated torque (SVC1)
	AVR	AVR is active while output voltage remains unchanged if input voltage is varying.
	Automatic Current Limit	Automatically limit output current, avoid tripping overcurrent frequently
DC Brake	Brake frequency:0.1~60Hz, brake time:0~30S, brake current:0~150% rated current	
Signal Input Source	Communication, analog voltage, analog current, preset speed, simple PLC and their combinations	
Special Function Control	Textile Wobulation	Achieve textile wobulation functions like wobulation range, time and jump
Function of Input and Output	Reference Power Supply	10V/20mA
	Terminal Control Power Supply	24V/150mA
	Numeric Input Terminals	7 programmable numeric input terminals
	Analog Input Terminals	4 analog inputs:2 voltage inputs (0~10V), and 2 current inputs(0~20mA)
	Numeric Output Terminals	2 OC outputs and 1 relay output are programmable. Maximum output current of OC: 50mA. Relay contact capacity: 250VAC/3A or 30VDC/1A. When relay acts, EA-EC is on, and EB-EC is off.
Analog output Terminals	2 programmable analog output terminals can output 0~10V or 0~20mA	
Keypad Display	LED	Human interactions with displays and control actuators
	Parameter Copy	Upload and download parameter information of the inverter, copy parameters rapidly.
Protections	Protections	Short circuit, overcurrent, overload, overvoltage, undervoltage, phase loss, overheating, external fault, and etc.
Application Conditions	Installation Site	Indoor, with altitude less than 1000 meters, free from dust, corrosive gas, and direct sunlight
	Ambient Temperature	-10℃~+40℃. In the temperature range +40℃...+50℃, the rated output current is decreased by 1% for every additional 1℃. 20%~90%RH (no condensation)
	Vibration	<0.5g
	Storage Temperature	-25℃~+65℃
	Installation Method	Wall mounting, floor mounting, flush mounting
Degree of Protection		IP20
Cooling Method		Forced air cooling

1.2 Definition of EM303B Operation Status

1.2.1 Operation Status of Inverter

- **Parameters setting status**
After power is on, inverter finishes initialization and enters standby status without fault or start-up command. Meanwhile, it does not output.
- **Normal running status**
After receiving active start command through keypad, control terminal or RS485, the inverter drives motor in accordance with the requirements of setting input.
- **JOG running status**
Set by keypad, external terminal or RS485 to make motor run as per JOG input speed.
- **JOG stop status**
Refer to the process that the output frequency drops to zero in JOG deceleration time after JOG running command is not active.
- **Autotuning status**
Set by keypad to autotune motor's parameters in stationary or rotational autotuning.
- **Stop status**
Refer to the process that the output frequency drops to zero in given deceleration time after running command is not active.
- **Fault status**
Status of inverter at protections, all kinds of faults and failures.

1.2.2 Control Modes of Inverter

The control modes of inverter refer to that the inverter controls motor rotation as per required speed and torque with open loop or close-loop control mode. The control modes include:

- **General open loop space vector control——V/F control**
Applicable to the applications of low speed changes and low speed stability accuracy demand, and meet needs of most of AC motor drives.
- **SVC 0—— Open-loop vector control without PG feedback**
Only estimate speed in real-time, but no feedback control. Output current is under real-time close-loop control, output of motor reaches 150% of rated torque at 0.5Hz, and inverter automatically traces load variables and limit output current to make it not exceed the maximum value. Even if there is sudden load change, quick acceleration or deceleration, inverter will not trip overcurrent, short-circuit, and etc., and keep high performance and reliability.
- **SVC1—— Torque control(Close-loop vector control without PG feedback)**
Not only estimate speed in real-time, but also conduct feedback control. Speed and current are under real-time close-loop control. Not only speed control but also torque control can be realized. A regular AC induction motor can perform as an AC variable speed motor and an AC torque motor by adopting this control mode. It is a genuine sensorless vector control.

1.2.3 Setting Modes of Inverter

The setting mode of inverter refers to that what kind of physical quantity inverter is taken as control object when driving motor.

Speed setting mode is to take motor speed as the control object

Torque setting mode is to take motor torque as the control object.

Set through various and flexible methods such as numeric setting, analog voltage, and analog current or other mathematical combinations. Jog speed setting mode is prior to other setting modes, i.e. when pressing $\frac{00}{47}$ on keypad or turning control terminals FJOG and RJOG on, no matter what the present setting mode is, the inverter will automatically switch to jog speed setting, or the combination of jog speed+primary speed or jog speed+auxiliary speed setting. See Figure 1-1 and Figure 1-2 for the details of all speed setting modes of EM303B.

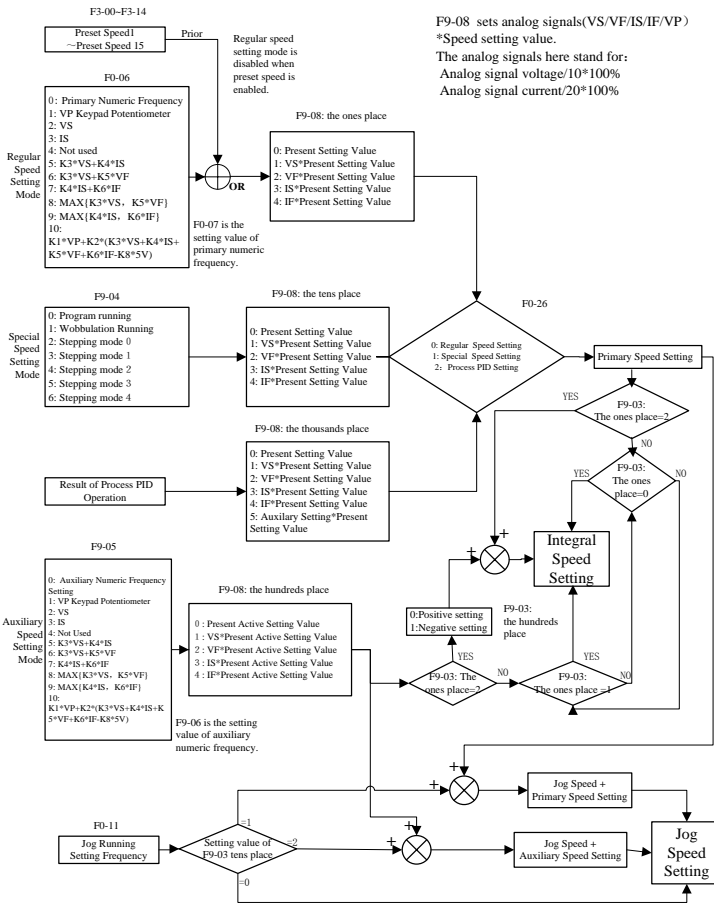
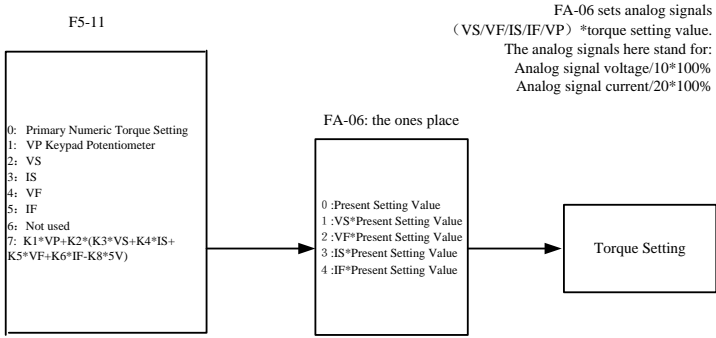

Figure 1-1 Speed Setting Modes



F5-12 is the setting value of primary numeric torque.

Figure 1-2 Torque Setting Mode

1.2.4 Start/Stop Control Mode of Inverter

The start/stop control mode of inverter refers to the modes to start/stop control of inverter. There are 3 control modes: keypad control mode, terminal control mode, and RS485 communication control mode. Terminal control mode is categorized as 2-wire sequence, and 3-wire sequence. See Figure 1-3 for the control logic of terminal control mode.

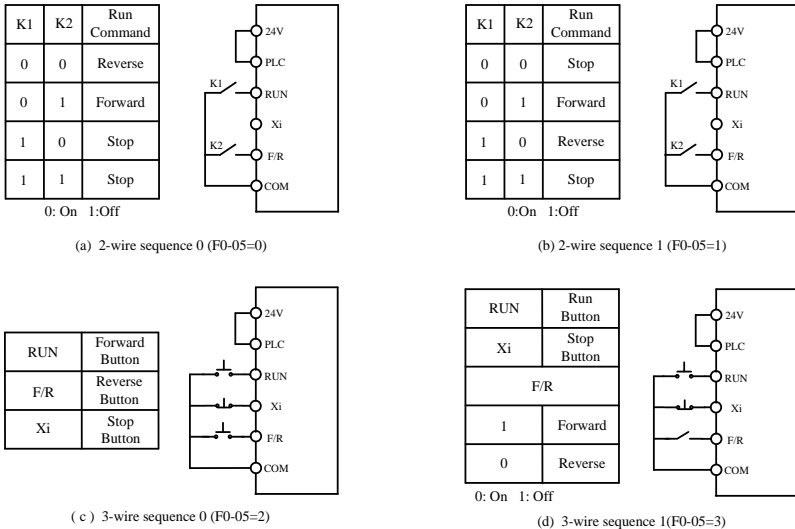

Figure 1-3 Control Logic of Terminal Control Mode

1.3 EM303B Outlook

See Figure 1-4 for the outlook of EM303B (Instance: EM303B- 4.0kW).

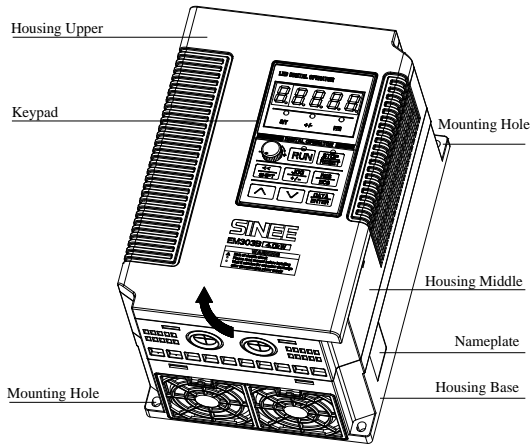
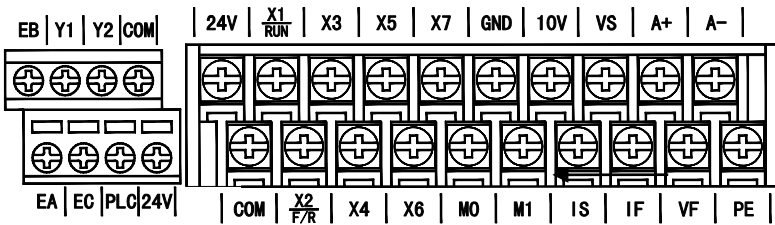
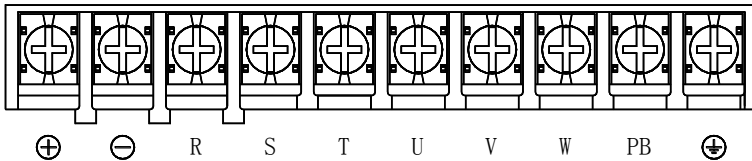

Figure1-4 EM303B Outlook

The housing upper can be disassembled by following the arrow shown in Figure1-4. See Figure 1-5 for control circuit terminals and main circuit terminals.



Control Circuit Terminal Block



Main Circuit Terminal Block

Figure 1-5 Control Circuit Terminal Block and Main Circuit Terminal Block

2 Installation

2.1 Verifying Product

Refer to Table 2-1, and check and verify the EM303B.

Table 2-1 Check List

Item	Action
If the products are identical to the purchase order.	Check the devices reference marked on the label.
Any part damaged.	Check the outlook if any damages.
Any screw loosened.	Check with a screwdriver if necessary.

Contact the distributor or SINEE directly for quality issue.

● Nameplate

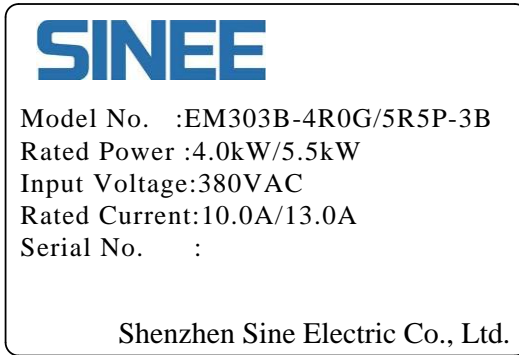

● Model Numbering Scheme

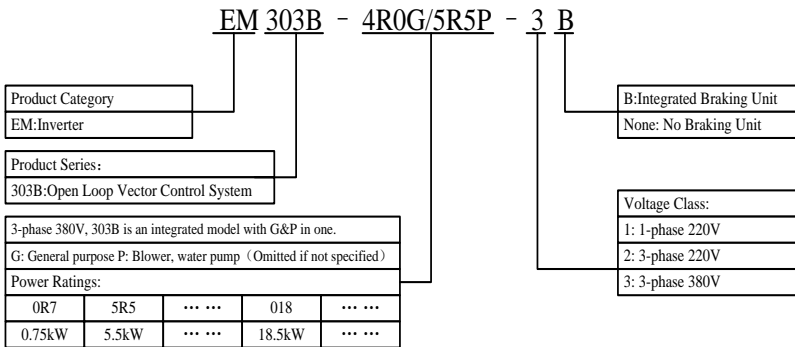

2.2 Overall and Installation Dimensions

EM303B can be classified to 10 sizes for total 30 models. See Figure 2-1 and Table 2-2 for installation dimensions.

The keypad can be installed on the metal panel separately with a hole size of $116.5 \pm 0.1(L) * 71.5 \pm 0.1(W)$ mm, and applicable metal panel thickness: $1.2 \sim 2.0$ mm.

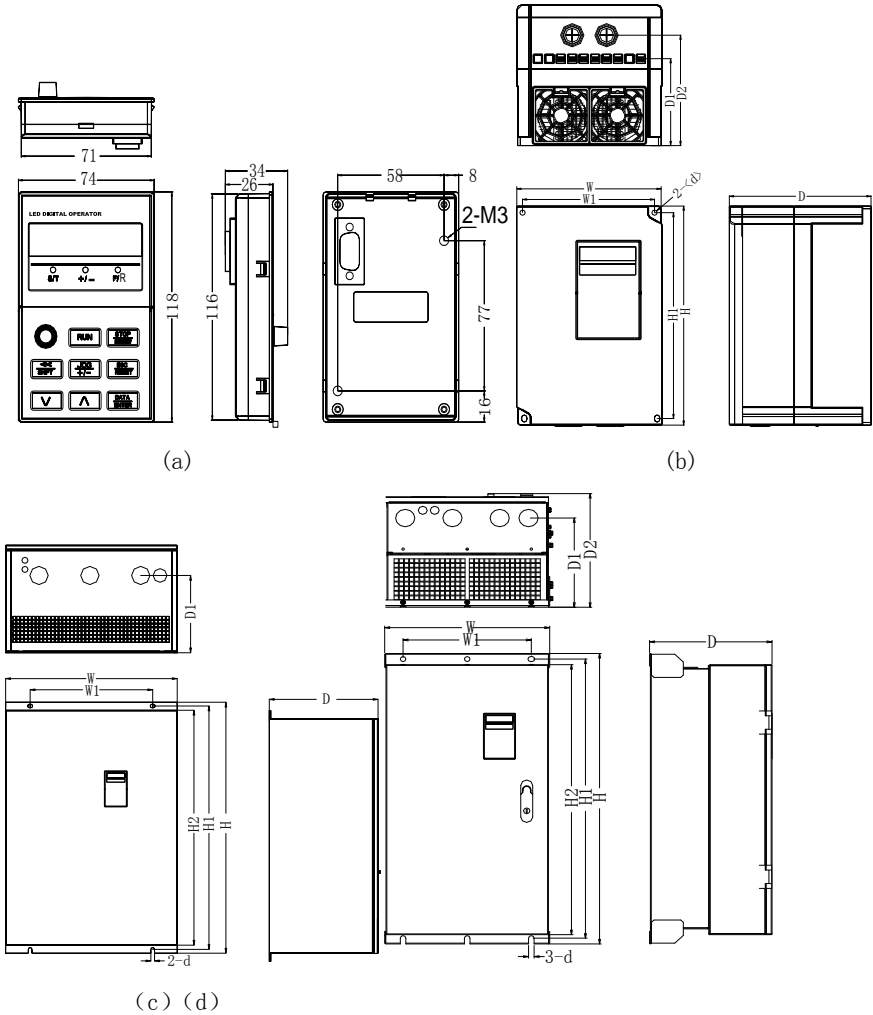

Figure 2-1 Overall and Keypad Dimensions of EM303B

Table 2-2 Overall Installation Dimensions of EM303B

Model No.	W	W1	H	H1	H2	D	D1	D2	d	Frame
EM303B-0R7G/1R1P-3B	140	125	220	205	--	152	120	161	6	(b)
EM303B-1R1G/1R5P-3B										
EM303B-1R5G/2R2P-3B										
EM303B-2R2G/3R0P-3B										
EM303B-3R0G/4R0P-3B										
EM303B-4R0G/5R5P-3B										
EM303B-5R5G/7R5P-3B	165	148	250	235	--	161	126	170	6	(b)
EM303B-7R5G/9R0P-3B										
EM303B-9R0G/011P-3B	215	150	352	335	317	215	172	224	7	(c)
EM303B-011G/015P-3B										
EM303B-015G/018P-3B										
EM303B-018G/022P-3	270	200	470	450	424	245	187	254	10	(c)
EM303B-022G/030P-3										
EM303B-030G/037P-3										
EM303B-037G/045P-3	335	240	550	530	500	245	190	254	10	(c)
EM303B-045G/055P-3										
EM303B-055G/075P-3	390	300	695	665	635	250	200	259	12	(c)
EM303B-075G/090P-3										
EM303B-090G/110P-3	386	300	753	724	700	287	231	295	13	(d)
EM303B-110G/132P-3	416	300	855	825	793	302	246	310	13	(d)
EM303B-132G/160P-3										
EM303B-160G/185P-3	497	397	1107	1076	1036	335	285	343	13	(d)
EM303B-185G/200P-3										
EM303B-200G/220P-3										
EM303B-220G/250P-3	656	450	1348	1314	1261	383	232	390	13	(d)
EM303B-250G/280P-3										
EM303B-280G/315P-3										
EM303B-315G/355P-3	801	680	1417	1383	1330	383	190	390	13	(d)
EM303B-355G/400P-3										
EM303B-400G/450P-3										

Remarks:

- 6modes, EM303B-055~075, EM303B-090, EM303B-110~132, EM303B-160~200, EM303B-220~280,and EM303B-315~400,can be floor-mounted with a chassis which is in the same width as the inverter. Heights of optional chassis: 120mm, 253mm, 253mm,308mm, 308mm and 355mm. Please order the extra chassis if needed, and see Section 11.6 for details.
- EM303B-090~400: power input terminals are on the top, and power output terminals are at the bottom of the inverter.

2.3 Considerations of Installation Site

2.3.1 Installation Site

Considerations for installation site:

- Good ventilation indoor
- Ambient temperature: $-10^{\circ}\text{C}\sim+40^{\circ}\text{C}$
- No high temperature and high moisture, humidity: $<90\%\text{RH}$, no water drops or any other condensation
- Never install on flammable materials
- No direct sunlight
- No flammable, corrosive gas or liquid
- No dust, floating fiber or metal particles
- Firm and steady installation base
- No electromagnetic interference, and keep away from interference source.

2.3.2 Ambient Temperature

Install inverter in a place with good ventilation to improve the reliability of inverter operation. When inverter is mounted inside a cabinet, cooling fan or air conditioner is a must. Keep the ambient temperature below $+40^{\circ}\text{C}$.

2.3.3 Precautions

Please take protective measures during installation to prevent foreign matters like metal particles or dust from entering the inverter when drilling. After installation, please take off the protective devices.

2.4 Direction and Space of Installation

Cooling fan(s) installed inside EM303B is for forced air cooling. For good cooling circulation, please mount inverter vertically, and leave sufficient space between the inverter and wall or other objects. See Figure 2-2.

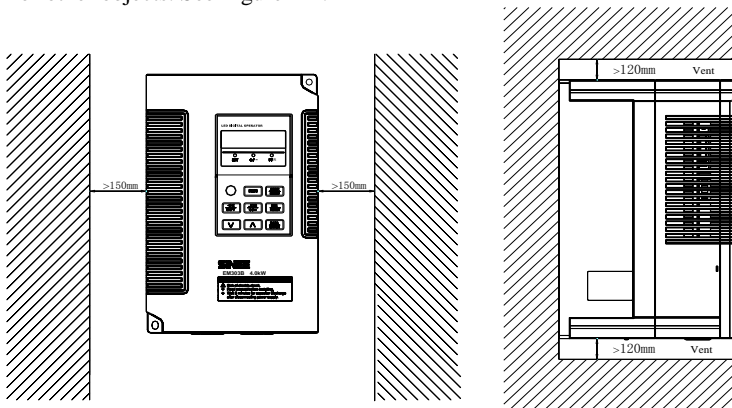

Figure 2-2 Direction and Installation of Inverter

Table 2-3 Table of Heat Dissipating Capacity (HDC), Mass Airflow(MAF), Noise and Net Weight(NW) of Single EM303B

Model No.	Frame	MAF (CFM)	MAF (m ³ /h)	HDC (W)	Noise (dB/A)	N.W. (kg)
EM303B-0R7G/1R1P-3B	Size 1	13	22	65	40	3.15
EM303B-1R1G/1R5P-3B				74		
EM303B-1R5G/2R2P-3B				80		
EM303B-2R2G/3R0P-3B				110		
EM303B-3R0G/4R0P-3B				135		
EM303B-4R0G/5R5P-3B				163		
EM303B-5R5G/7R5P-3B	Size 2	27	45	185	40	4.3
EM303B-7R5G/9R0P-3B				300		
EM303B-9R0G/011P-3B	Size 3	59	100	325	45	12.3
EM303B-011G/015P-3B				385		
EM303B-015G/018P-3B				525		
EM303B-018G/022P-3	Size 4	80	135	515	56	19.5
EM303B-022G/030P-3				640		
EM303B-030G/037P-3				870		
EM303B-037G/045P-3	Size 5	165	280	1025	56	30.5
EM303B-045G/055P-3				1158		
EM303B-055G/075P-3	Size 6	247	420	1525	56	51.3
EM303B-075G/090P-3				1800		
EM303B-090G/110P-3	Size 7	335	570	2120	62	80.2
EM303B-110G/132P-3	Size 8	403	684	2636	62	93.8
EM303B-132G/160P-3				3216		
EM303B-160G/185P-3	Size 9	424	720	3881	62	154.8
EM303B-185G/200P-3				4272		
EM303B-200G/220P-3				4568		
EM303B-220G/250P-3	Size 10	706	1200	4915	73	240
EM303B-250G/280P-3				5442		
EM303B-280G/315P-3				6152		
EM303B-315G/355P-3	Size 11	706	1200	8098	73	290
EM303B-355G/400P-3				8830		
EM303B-400G/450P-3				9418		

Remarks:

1. The values listed in the table refer to that the HDC and MAF required when single EM303B is mounted in an enclosed place.
2. The HDC is calculated based on the rated voltage, rated current and preset carrier frequency of each model.
3. 3. If more than one EM303B have to be installed in an enclosed place, please add HDC and MAF.

2.5 Disassembly and Assembly of Keypad

Generally it is unnecessary to disassemble the keypad, and just remove the cover to assemble and wire. On special occasions, disassemble the keypad by following steps.

- Remove the front cover: For EM303B-0R7~7R5, push the cover vertically from the bottom with two hands, and then lift up outwards. See Figure 2-3.

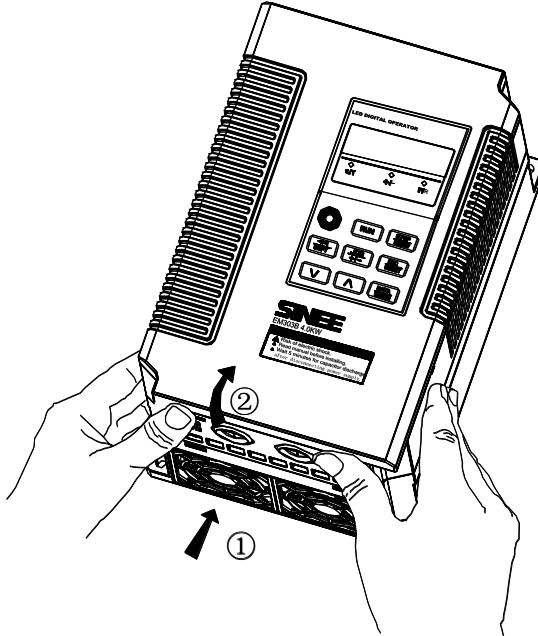

Figure2-3 Remove the Front Cover

- Disassemble the keypad: Put your fingers in the insert on the top of keypad, press down slightly, and pull outwards, then the keypad can be removed. See Figure 2-4.

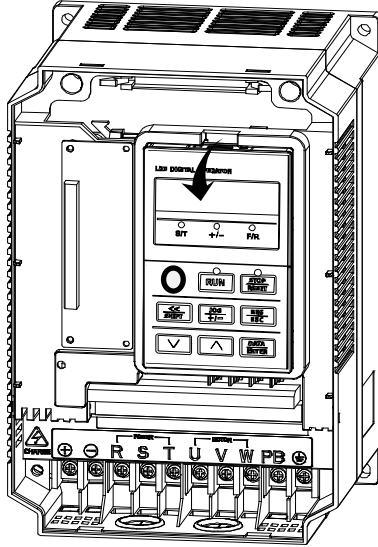

Figure 2-4 Disassemble the Keypad

- Assemble the keypad: Place the bottom of keypad in the slot and then press the top to push until it clicks into right place. See Figure 2-5.

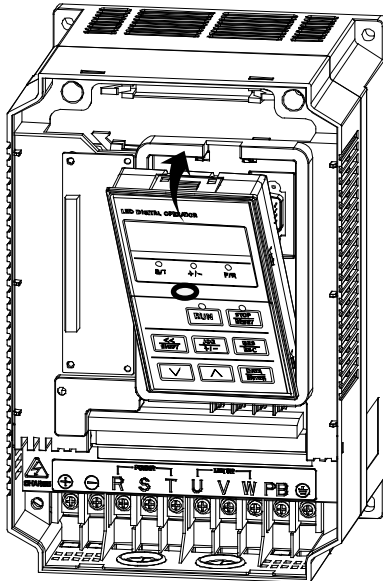

Figure 2-5 Assemble the Keypad

2.6 Flush Mounting

EM303B-090,EM303B-110~132,EM303B-160~200 can be installed in flush mounting.
The mounting method:

Please move the flanges on the top and bottom of the housing from the place as shown in Figure 2-6 to the place as shown in Figure 2-7. It only needs to unscrew the bolts of flanges and assemble at the right places. See Figure 2-8 for the installation dimensions.

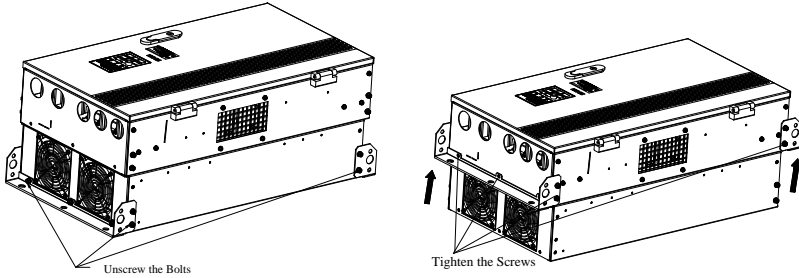

Figure 2-6 Disassembling the Flanges Figure 2-7 Assembling the Flanges

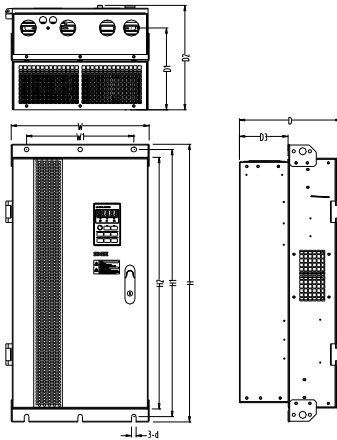

Figure 2-8 Installation Dimensions for Flush Mounting

Model No.	W	W1	H	H1	H2	D	D1	D2	D3	d
EM303B-090G/110P-3	386	300	753	724	700	287	231	295	136	13
EM303B-110G/132P-3	416	300	855	825	793	302	246	310	132	13
EM303B-160G/185P-3	497	397	1107	1076	1036	335	285	343	145	13
EM303B-200G/220P-3										

3 Wiring

3.1 Connections to Peripherals

Connections between EM303B and its peripherals are shown in Figure 3-1

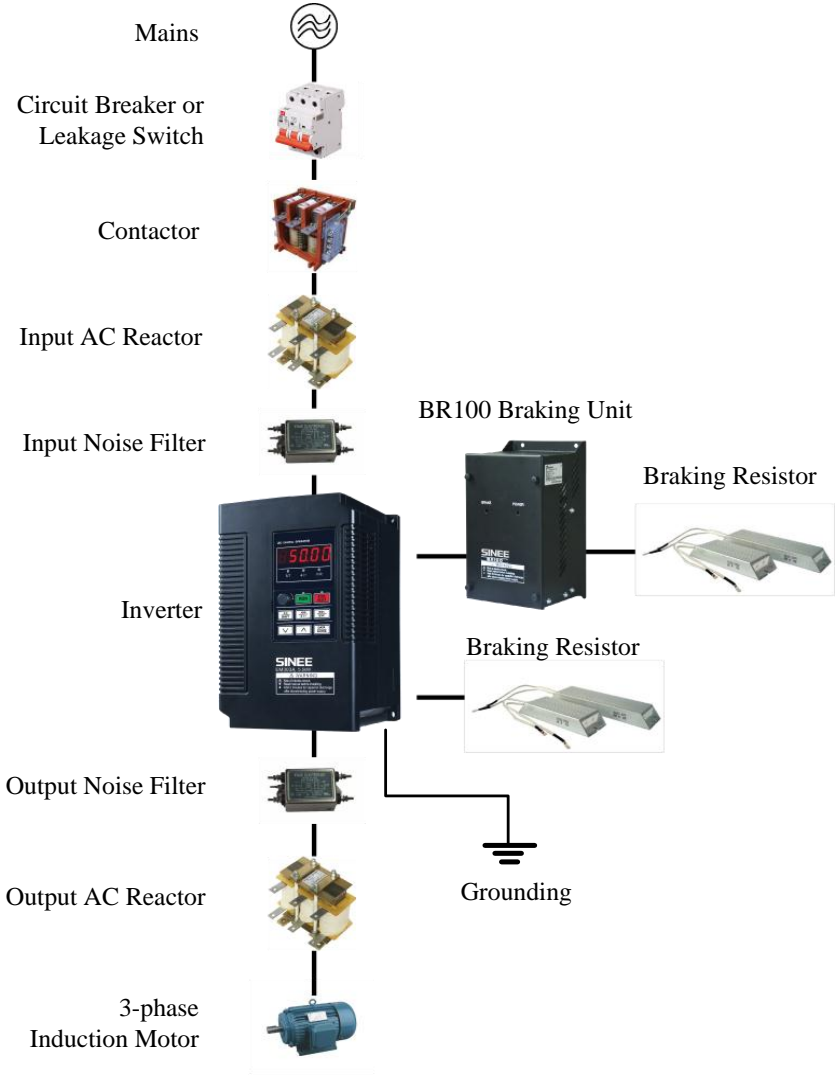

Figure 3-1 EM303B Peripherals Connections

3.2 Wiring Main Circuit Terminals

3.2.1 Main Circuit Terminal Block

The main circuit terminals of EM303B are located on the control PCBA:

- 3-phase AC input terminals: R,S,T
- Grounding terminal: \oplus
- DC bus terminal: $\oplus \ominus$
- Wiring terminal for braking resistor: PB
- Output terminals of inverter(For connecting to motor): U, V, W

See Figure 3-2 for main circuit terminal block.

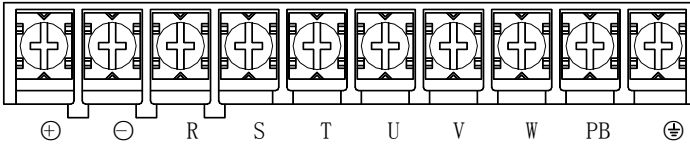

(a) Main Circuit Terminal Block of EM303B-015 or below

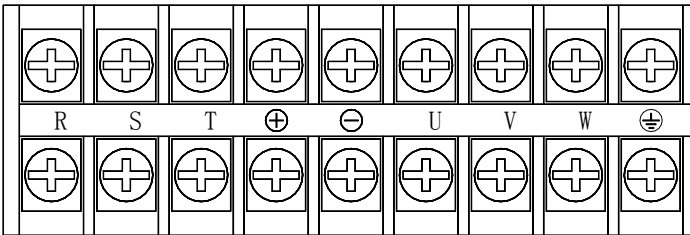

(b) Main Circuit Terminal Block of EM303B -018~075

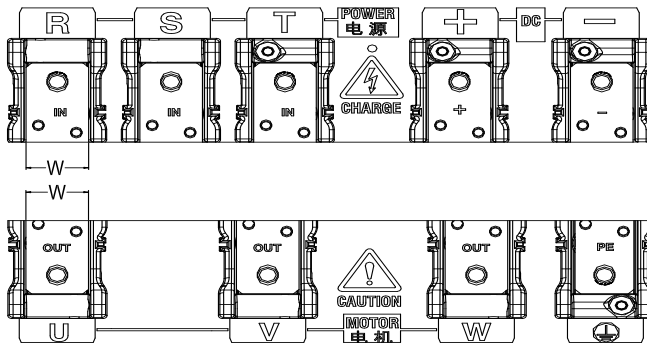

(c) Main Circuit Terminal Block of EM303B -090~200

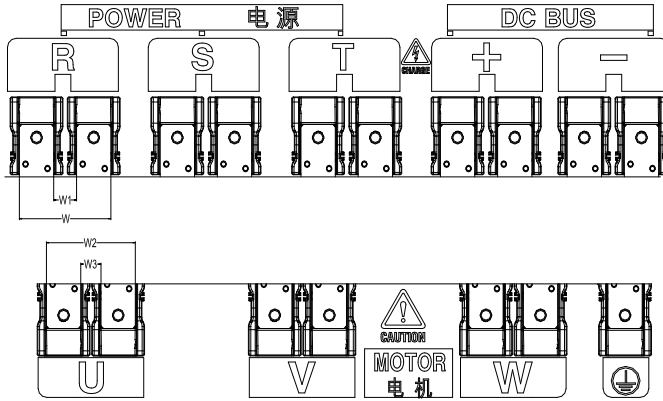

(d) Main Circuit Terminal Block of EM303B -220~400

Figure3-2 Main Circuit Terminal Block

Inverter Model No.	W	W1	W2	W3
EM303B-090~132	33	-	-	-
EM303B-160~200	39	-	-	-
EM303B-220~280	88	22	88	22
EM303B-315~400	104	26	101	23

Remarks:

- EM303B -090 or above: Power input terminals R, S, and T are on the top, and power output terminals are at the bottom of the inverter.
- EM303B -220 or above: There are 2 wiring screws for each terminal.

3.2.2 Main Circuit Terminal Functions

The main circuit terminal functions of EM303B are listed in Table 3-1. Please wire the terminals correctly as per corresponding function.

Table 3-1 Main Circuit Terminal Functions

Terminal	Function
R、S、T	AC power input terminals for connecting to 3-phase AC power. (Terminal L1, L2 for AC220V 1-phase input inverter)
U、V、W	Inverter AC output terminals for connecting to 3-phase induction motor.
⊕ ⊖	Positive and negative terminals of internal DC bus for connecting to external braking unit.
⊕、PB	Connecting terminals of braking resistor, one end connected to ⊕ and the other to PB.
⊕	Grounding terminals

3.2.3 Internal Main Circuit

See Figure 3-3 for the internal main circuit structure of EM303B.

Figure 3-3 Internal Main Circuit

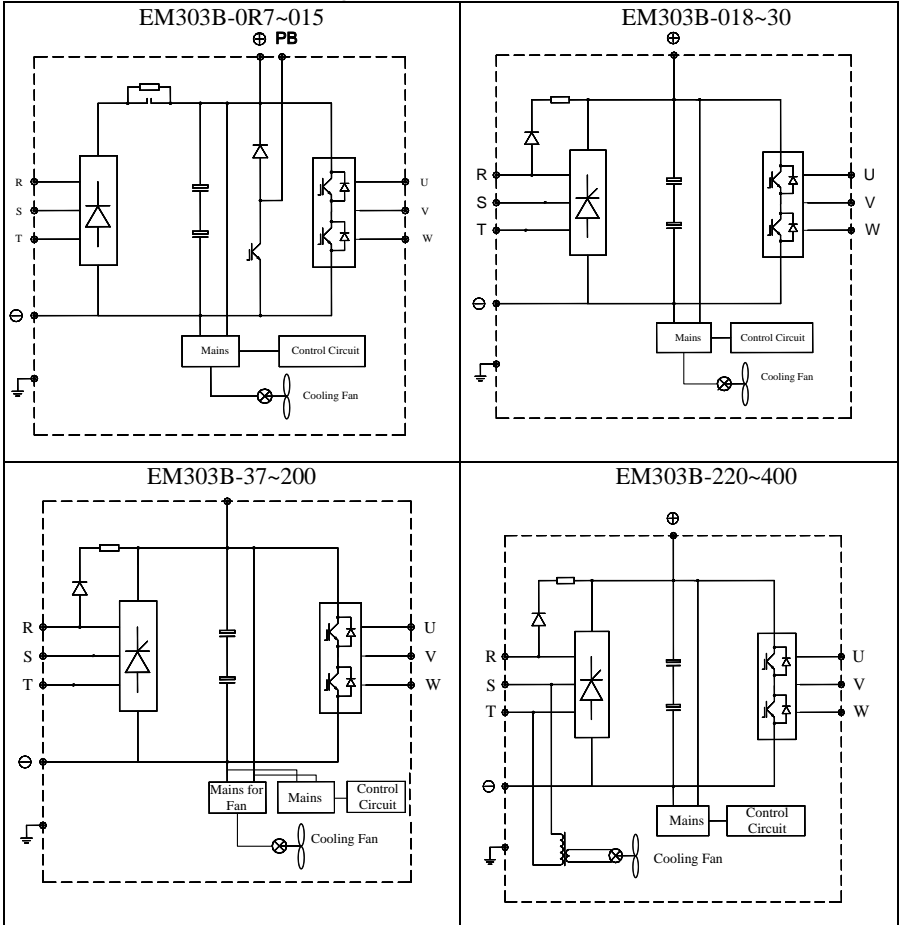

3.2.4 Standard Wiring of Main Circuit

See Figure 3-4 for standard wiring of main circuit.

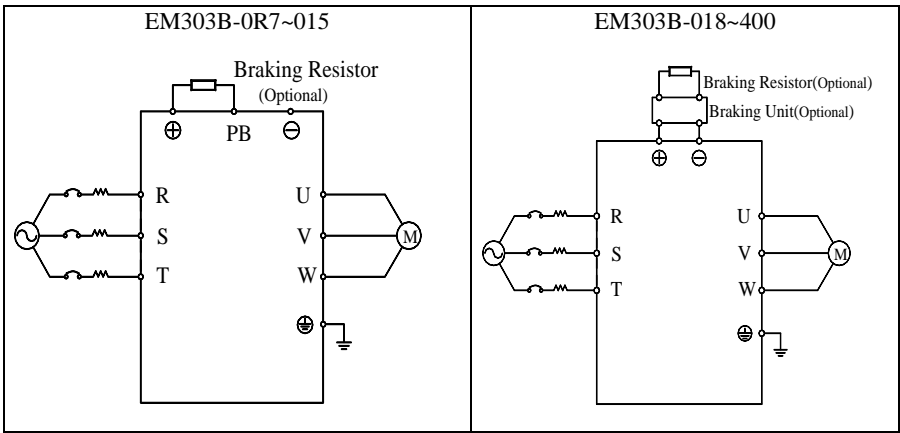

Figure 3-4 Standard Wiring of Main Circuit

3.2.5 Wiring Main Circuit on Input Side

Installing a Circuit Breaker

Always install an air circuit breaker (MCCB) between the power supply and input terminals.

- Choose a MCCB with a capacity of 1.5-2 times of the inverter's rated current.
- The time characteristics of MCCB should meet that of inverter's overheating protection (150% of rated current /1 minute).
- If single MCCB is shared by two or more inverters or other devices, the contact of fault output relay shall be connected to power contactor coil, so that the power supply will be turned off by the fault signals, as shown in Figure 3-5.

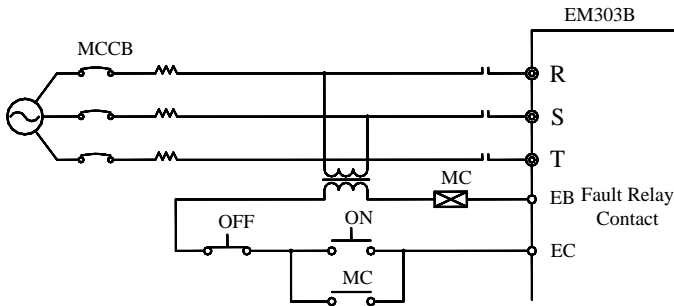

Figure 3-5 Connecting to Input Circuit Breaker

Installing a Leakage Circuit Breaker

High frequency leakage current is generated by high frequency PWM signal output of inverter. Select a special purpose leakage breaker with a trigger current $\geq 30\text{mA}$. For a regular leakage breaker, the trigger current $\geq 200\text{mA}$ and the active time at 0.1S or above.

Installing an Electromagnetic Contactor

Install an electromagnetic contactor which is applicable to inverter as shown in Figure 3-5.

- Start/stop of the inverter can be controlled by the electromagnetic contactor on input side. Inverter may break down if the electromagnetic contactor is on and off frequently. The operation interval between start and stop of the inverter shall ≥ 30 minutes.
- The inverter will not automatically start after power failure.

Connecting to the Terminal Block

Power input phase sequence is not related to the phase sequence of terminals R, S, and T on the terminal block, any two of them can be connected randomly.

Installing an AC Reactor

If the inverter is connected to a transformer with big-capacity ($\geq 600\text{kVA}$), or power supply is connected to capacitive load, an excessive big surge current will occur and rectifier of inverter can be broken down. Install an optional 3-phase AC reactor on input side of inverter to suppress peak current and voltage, and improve power factor of the system.

Installing a Surge Absorber

Install a surge absorber for inductive loads (electromagnetic contactors, solenoid valves, solenoid coils, or electromagnetic circuit breakers) nearby the inverter.

Installing a Noise Filter on Power Supply Side

To filter noise transmitted between power cable and the inverter, and the harmonic distortion of power grid caused by the noise produced by the inverter.

- A special purpose noise filter is required for the inverter.
- Correct vs incorrect installations of noise filters as shown in Figure 3-6 and Figure 3-7.

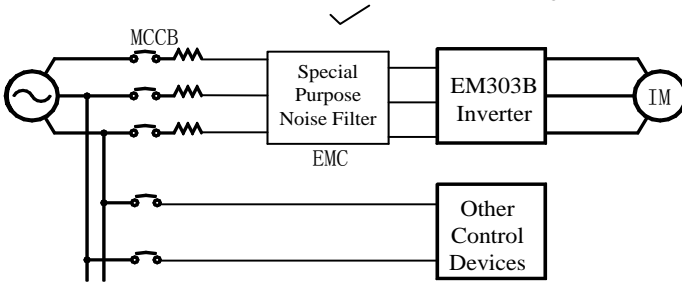
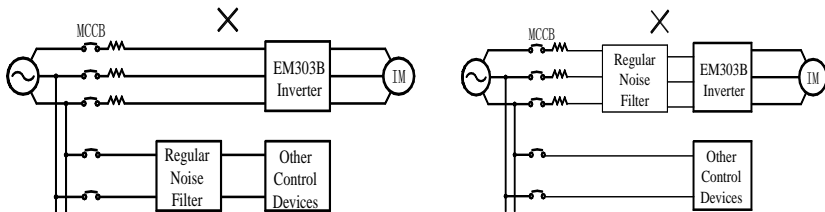

Figure 3-6 Correct Noise Filter Installation



(a) (b)
Figure 3-7 Incorrect Noise Filter Installation

3.2.6 Wiring the Output Side of Main Circuit

Connecting the Inverter to Motor

- Connect inverter output terminals U, V, and W to motor input terminals U, V and W.
- Confirm that the motor forwards with the Forward Command. Switch any 2 of the inverter output terminals U, V, or W to each other and reconnect if the motor reverses.

Never Connecting Power Supply Cable to Output Terminals

Never connect power supply cable to output terminals. If the output terminals are connected to power supply, the inverter would be damaged.

Never Short-Circuiting or Grounding Output Terminals

Never touch output terminals directly with bare hands, or connect the output cable to the housing of inverter. Otherwise, an electric shock and short-circuit may occur. Furthermore, do not short-circuit the output cable.

Never Using a Phase-shifting Capacitor

Never connect phase-shifting electrolytic capacitor or LC/RC filter to the output circuit. Otherwise, inverter will be damaged.

Never Using an Electromagnetic Switch

- Never connect electromagnetic switch or electromagnetic contactor to the output circuit. Otherwise, failure to comply will cause overcurrent or overvoltage protection. Even worse, inverter will be damaged.
- Please make sure that the inverter stops before installing electromagnetic contactor to switch grid power supply.

Installing a Noise Filter on the Output Side

Install a noise filter on the output side of inverter to reduce inductive interference and radio interference.

- Inductive interference: Electromagnetic induction generates noise on the signal line which may cause the control device malfunction.
- Radio interference: The high frequency electromagnetic waves generated by inverter and cable cause radio devices nearby to make noise when receiving signals.

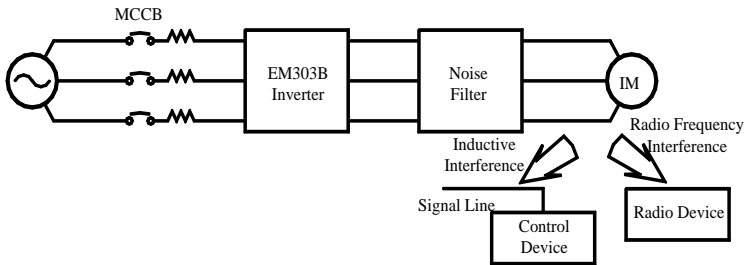

Figure 3-8 Installing a Noise Filter on the Output Side

Countermeasures Against Inductive Interference

As stated previously, except installing a noise filter, all output cables can be routed through a grounded metal pipe to prevent inductive interference on the output side. The distance between output cables and signal line should $>30\text{cm}$, and the inductive interference will be reduced considerably, as shown in Figure 3-9.

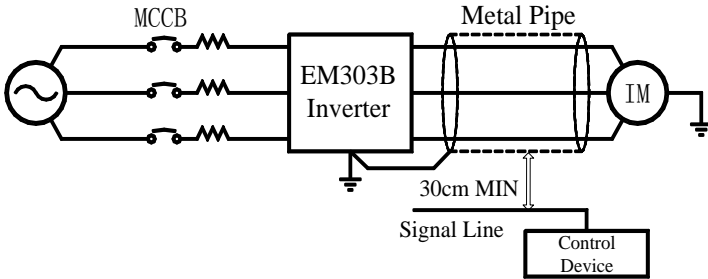

Figure 3-9 Countermeasures Against Inductive Interference

Countermeasures Against Radio Frequency Interference (RFI)

RFI will be generated from the inverter as well as the input cable and the output cable. Install noise filters on both input and output sides, and shield inverter with an iron case to reduce RFI. As shown in Figure 3-10.

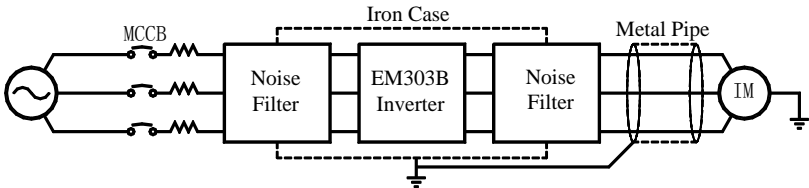

Figure 3-10 Countermeasures Against RFI

Cable Length Between Inverter and Motor

The longer cable between the inverter and motor is, the higher carrier frequency is, and the greater high-frequency harmonic leakage current on its cable is. All of which will affect inverter and its peripherals. See Table 3-2 to adjust carrier frequency for reducing the high-frequency harmonic leakage current.

When motor cable $>50\text{m}$, please connect a special 3-phase AC reactor of the same capacity as that of the inverter to the output terminals.

Table 3-2 Cable Length and Carrier Frequency Between Inverter and Motor

Cable Length	$<50\text{m}$	$<100\text{m}$	$>100\text{m}$
Carrier Frequency	$<10\text{kHz}$	$<8\text{kHz}$	$<5\text{kHz}$
F0-14 Function Parameter	10.000	5.000	2.000

3.2.7 Main Circuit Cable and Terminal Screw Size

See Table 3-3 for the specifications of main circuit cable and terminal screw.

Table 3-3 Main Circuit Cable and Terminal Screw Specifications

Model No.	Terminals	Terminal Screw	Tightening Torque (N.m)	Cable Size (mm ²)	Cable Type
EM303B-0R7G/1R1P-3B	⊕, ⊖, R, S, T, U, V, W, PB, ⊕	M3.5	1.2~1.5	1.5	750V
EM303B-1R1G/1R5P-3B		M3.5	1.2~1.5	2.5	
EM303B-1R5G/2R2P-3B		M3.5	1.2~1.5	2.5	
EM303B-2R2G/3R0P-3B		M3.5	1.2~1.5	4	
EM303B-3R0G/4R0P-3B		M3.5	1.2~1.5	4	
EM303B-4R0G/5R5P-3B		M3.5	1.2~1.5	4	
EM303B-5R5G/7R5P-3B		M4	1.5~2.0	6	
EM303B-7R5G/9R0P-3B		M4	1.5~2.0	6	
EM303B-9R0G/011P-3B		M5	3.0~4.0	6	
EM303B-011G/015P-3B		M5	3.0~4.0	10	
EM303B-015G/018P-3B		M5	3.0~4.0	10	
EM303B-018G/022P-3		M6	4.0~5.0	16	
EM303B-022G/030P-3		M6	4.0~5.0	16	
EM303B-030G/037P-3		M6	4.0~5.0	25	
EM303B-037G/045P-3		M8	9.0~10.0	25	
EM303B-045G/055P-3		M8	9.0~10.0	35	
EM303B-055G/075P-3		M10	17.0~22.0	35	
EM303B-075G/090P-3		M10	17.0~22.0	60	
EM303B-090G/110P-3		M10	17.0~22.0	60	
EM303B-110G/132P-3		M10	17.0~22.0	90	
EM303B-132G/160P-3		M10	17.0~22.0	90	
EM303B-160G/185P-3		M12	31.0~39.0	120	
EM303B-185G/200P-3		M12	31.0~39.0	180	
EM303B-200G/220P-3		M12	31.0~39.0	180	
EM303B-220G/250P-3		2*M10	17.0~22.0	2*120	
EM303B-250G/280P-3		2*M10	17.0~22.0	2*120	
EM303B-280G/315P-3	2*M10	17.0~22.0	2*150		
EM303B-315G/355P-3	2*M12	31.0~39.0	2*150		
EM303B-355G/400P-3	2*M12	31.0~39.0	2*150		
EM303B-400G/450P-3	2*M12	31.0~39.0	2*180		

Remarks:

1. Take the voltage drop into consideration for selecting cable. Generally the voltage drop should be $< 5V$ and calculated according to following formula:
Voltage drop = $\sqrt{3} \times \text{Cable resistance ratio } (\Omega/\text{KM}) \times \text{Cable length (m)} \times \text{Rated current (A)} \times 10^{-3}$
2. If placed in plastic duct, the cable should be uprated by one level.
3. The cable should be connected to the applicable cable and wiring terminal.
4. The size of grounding cable should be the same as that of power cable when the size of power cable is less than 16mm^2 . However, when the size of power cable $> 16\text{mm}^2$, the size of grounding cable should not be less than half of it, but at least 16mm^2 .

3.2.8 Ground Wiring

- Make sure the ground terminal  grounded.
- Do not share the grounding cable with welding machine or power equipment.
- The size of grounding cable should meet the technical standard of electrical appliances, and the distance to grounding point should be as short as possible.
- Do not form the grounding cable as a circuit whenever two or more inverters are used synchronously. See Figure 3-11 for the correct and incorrect grounding wirings.

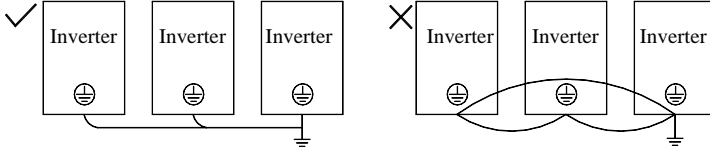

Figure 3-11 Ground Wiring

3.2.9 Wiring Braking Resistor and Braking Unit

See Chapter 11 for details of the selection and wiring of braking resistor and braking unit.

3.3 Wiring Control Circuit Terminals

3.3.1 Control Circuit Terminals

The control circuit terminals of EM303B are located on the control PCBA:

- Analog input terminals: Voltage input signals VS and VF. Current input signals IS and IF.
- Numeric input terminals: X1, X2, X3, X4, X5, X6, X7, PLC
- Numeric output terminals: EA, EB, EC, Y1, Y2
- Analog output terminals: M0, M1
- Auxiliary power supply terminals: +24V, COM, +10V, GND.
- RS485 communication interface: A+, A-
- Ground terminal: PE

See Figure 3-12 for control circuit terminal block.

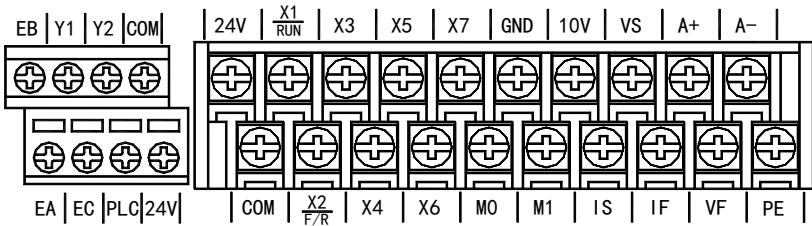

Figure 3-12 Control Circuit Terminal Block

3.3.2 Function and Wiring of Control Circuit Terminals

Function of control circuit terminals as shown in Table 3-4

Table 3-4 Function of Control Circuit Terminals

Mode	Terminal	Terminal Name	Terminal Function
Analog Input	VS	VS Analog voltage input	0/2~10V(It can be set as numeric input terminal)
	VF	VF Analog voltage input	0/2~10V(It can be set as numeric input terminal)
	IS	IS Analog current input	0/4~20mA(It can be set as numeric input terminal)
	IF	IF Analog current input	0/4~20mA(It can be set as numeric input terminal)
Numeric Input	X1-RUN X2- F/R X3~ X7	Multi-function input terminal	Program the relevant terminals by setting F2-00~F2-06 to control the input of setting function(Common Terminal: PLC)
	COM	Multi-function input common terminal	Switching value input/output signal common terminal(Ground of 24V power supply)
	PLC	Multi-function input common terminal	Common terminal for external connection with 24V The default is to connect with 24V supply
Relay Output	EA	Relay output terminal	EA-EC:NO EB-EC:NC
	EB		
	EC		
Multi-functi on Output	Y1	OC output terminal 1	Programmable multi-function output terminals as shown in F2-12, F2-13.
	Y2	OC output terminal 2	
Analog Output	M0	Analog output terminal 0	Analog output 0~10V or 0~20mA can be defined by setting of F2-16, F2-17 or F2-19, F2-20.
	M1	Analog output terminal 1	
Auxiliary Power Supply	10V	Analog terminal power supply	+10V/20mA
	GND	Common terminal of analog quantity	Common terminal of analog input and output signals(Ground of 10V power supply)
	24V	Auxiliary power supply(+)	Output of DC24V/150mA between it and COM
	COM	Switching value common terminal	Common terminal of switching value input/output signal (Ground of 24V power supply)
Communica -tion	A+	RS485 communications terminal	RS485 Communications input(+)
	A-		RS485 Communications input(-)
Shield	PE	Shield ground	For shield terminal cable grounding

3.3.3 Wiring the Analog Input Terminals

Wiring terminals VS and VF through analog voltage signal:

When analog voltage input signal is as the external power supply, terminals VS and VF shall be wired as per the method shown in Figure 3-13, and terminals IS and IF shall be wired as per the method shown in Figure 3-14.

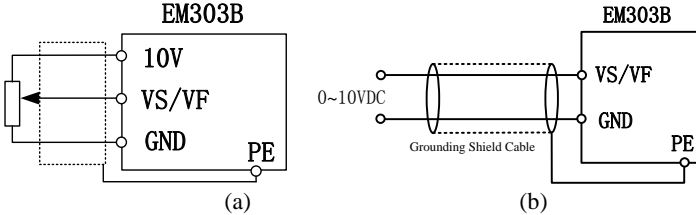

Figure 3-13 Wiring of Terminals VS and VF

Wiring terminals IS and IF analog current signal:

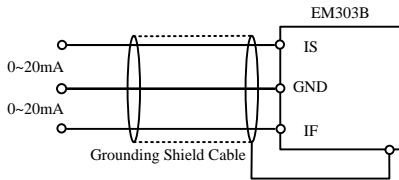
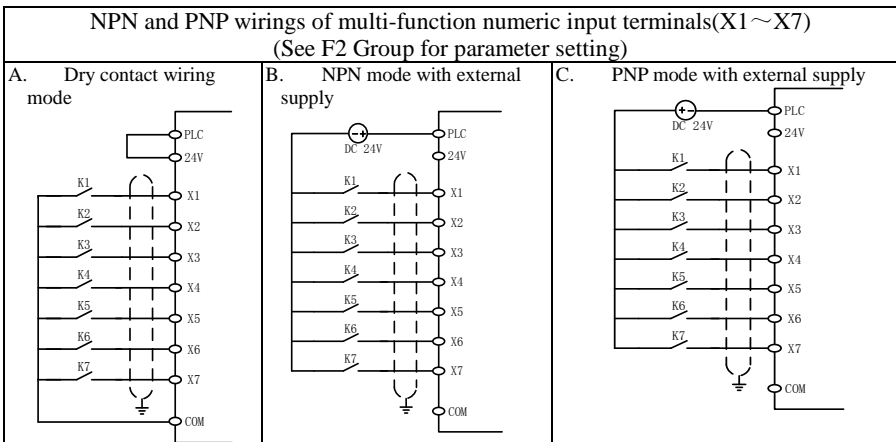

Figure 3-14 Wiring of Terminals IS and IF

3.3.4 Wiring Multi-function Input Terminal

The multi-function input terminals of EM303B adopt full bridge rectifier circuit. Terminal PLC is the common terminal of X1~X7. The current passed through the PLC terminal can be forward (NPN Mode) or reverse (PNP mode), so that it is flexible to connect terminals X1-X7 to external devices. The typical wirings are as shown in the followings:



3.3.4.1 Dry contact wiring mode

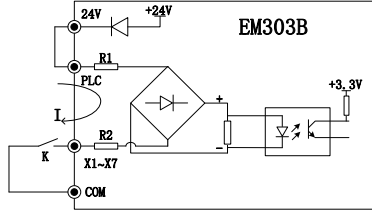

Figure 3-15-a Wiring with 24V Internal Power Supply

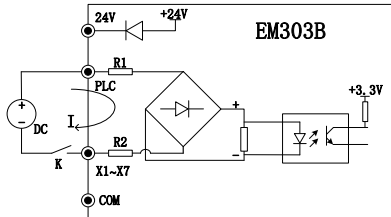

Figure 3-15-b Wiring with External Power Supply

3.3.4.2 NPN and PNP mode

A. See Figure 3-16-a for NPN mode with 24 internal power supply

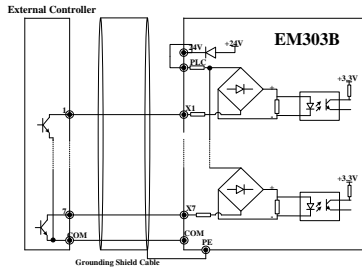

Figure 3-16-a NPN Mode with 24 Internal Power Supply

B. See Figure 3-16-b for PNP mode with 24 internal power supply (Please disconnect terminal PLC from terminal 24V)

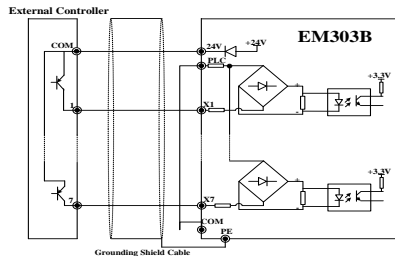

Figure 3-16-b PNP Mode with 24 Internal Power Supply

C. See Figure 3-16-c for NPN mode with external power supply (Please note that disconnect terminal PLC from terminal 24V)

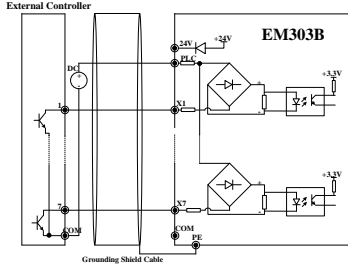

Figure 3-16-c NPN Mode with External Power Supply

D. See Figure 3-16-d for PNP mode with external power supply (Please note that disconnect terminal PLC from terminal 24V).

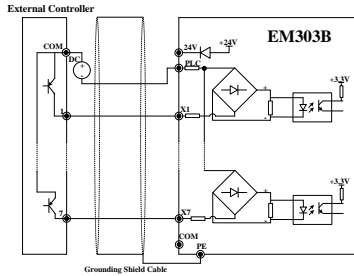

Figure 3-16-d PNP Mode with External Power Supply

3.3.5 Wiring Relay Output Terminal

The surge voltage absorbing circuit should be installed for inductive load like relay or contactor. For instance: RC absorbing circuit (please note that the leakage current < the working current of contactor or relay being controlled), VDR or fly-wheel diode and etc. (For DC electromagnetic circuit, please pay attention to the polarity at installation). The component of absorbing circuit should be installed near the ends of relay coil or contactor.

3.3.6 Wiring Multi-function Output Terminal

Multi-function output terminals Y1 and Y2 can take 24V internal power supply of inverter or external power supply as shown in Figure 3-17.

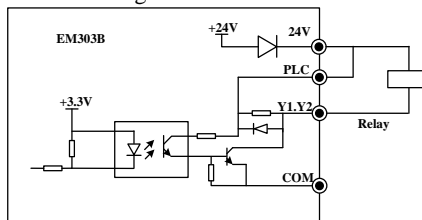

Figure 3-17-a Multi-function Terminal with Internal Power Supply

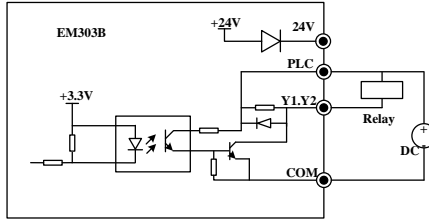

Figure 3-17-b Multi-function Terminal with External Power Supply

Remarks:

If the multi-function output terminal is powered by external supply, then the multi-function input terminal should be applied with the same supply, to avoid short circuit when input terminal is set as PNP mode.

3.3.7 Wiring Analog Output Terminals

Analog output terminals M0 and M1 can represent various physical quantities when connected to external analog meter. The specifications of jumper are taken as: 0~20mA output current or 0~10V output voltage. Here M0 and M1 correspond to JP1 and JP2 respectively. See Figure 3-18 for details.

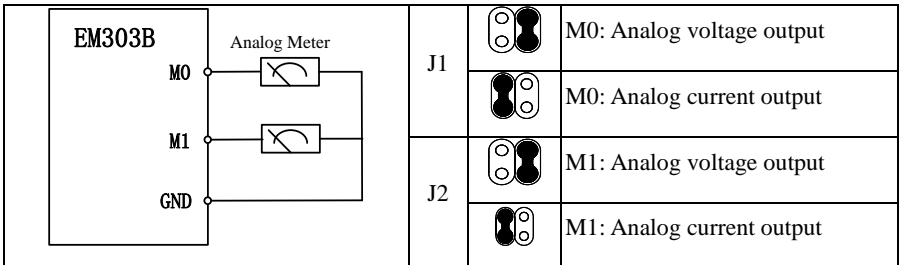

Figure 3-18 Wiring Analog Output Terminal

3.3.8 Wiring Communication Terminal

Terminals A+ and A- are the RS485 communication terminals of the inverter. The control network between PC or PLC and inverter can be achieved through connecting communication with PC or PLC. See Figure 3-19 and Figure 3-20 for connection of RS485, RS485/RS232 converter and EM303B.

- Connect to PC or PLC through RS485 terminal

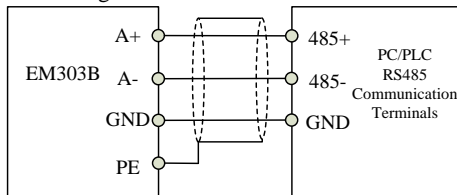

Figure 3-19 Wiring Communication Terminals

- Connect to PC or PLC through RS485/RS232 converter

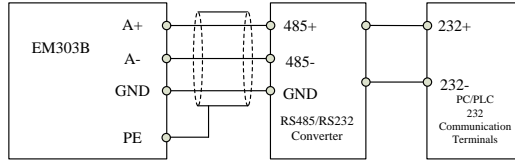

Figure 3-20 Wiring Communication Terminals

Remarks:

For the applications with severe electromagnetic noise, please ground the GND of communication points to the common ground.

3.3.9 Size of Control Circuit Cable and Screw

To lower interference and attenuation of control signal, the cable length of control signal should be in a maximum of 50m, and the distance should be in a minimum 30cm between the signal cable and the power cable. Twisted-pair cable or shielded cable shall be used when inputting analog signal externally. It shall be the best to take 0.5~1mm² cable as the control circuit cable.

There are two types of control circuit wiring terminals for EM303B: clamp terminal and barrier terminal, please install them with a PH0 cross head screwdriver with a tightening torque of 0.5N.m. Please pay attention to followings based on different features of these two terminals:

Clamp terminal

- Take pin terminal or cable strip length by 5~7mm for connection.
- Only after the terminal screw is fully loosened anticlockwise first, the cable can be inserted.

Barrier terminal

- Take a circular or a U-sharp clamp terminal with holes of 3.5mm.

3.3.10 Precautions for Wiring Control Circuit

1. Separate the control circuit cable from the other cables.
2. Separate the cable of control circuit terminals EA, EB, EC, Y1, and Y2 from the cables of other control circuit terminals.
3. Use shielded twisted-pair cables for control circuit to avoid malfunctions caused by interference. The wiring distance should be in a maximum of 50m.
4. Wrap the shield net with insulating tape to prevent the shield net from contacting with other signal cables and housing of device.

3.3.11 Standard Control Circuit Wiring

See Figure 3-21 for standard control circuit wiring of EM303B.

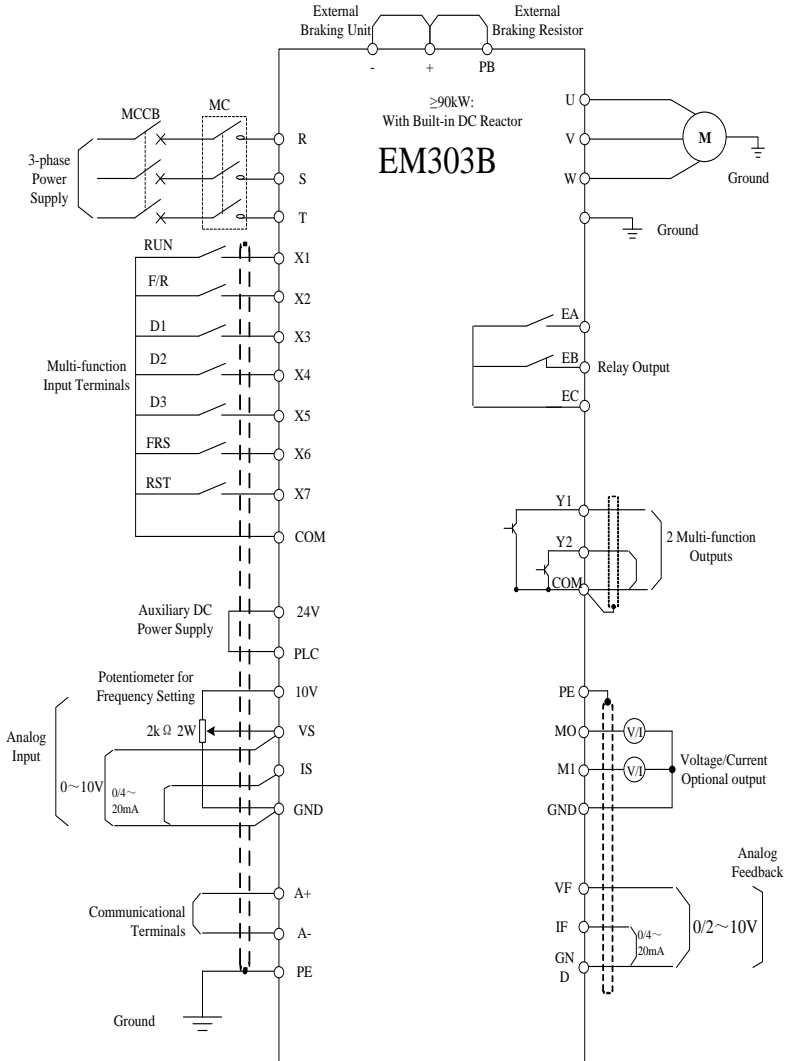

Figure 3-21 Standard Control Circuit Wiring of EM303B

Remarks: EM303B-018~400: No PB terminal.

3.4 Extending Keypad Wire

Please disassemble the keypad of EM303B as per the method shown in Figure 2-3, connect to an extension wire, assemble the keypad in a proper place, and then take it as a control panel. Please disassemble the keypad and connect extension keypad wire by following the method as shown in Figure 3-22. If the extension wire exceeds 10m, a remote control keypad is required.

If the keypad wire is also a control circuit wire, wiring precautions as stated in 3.3.4.

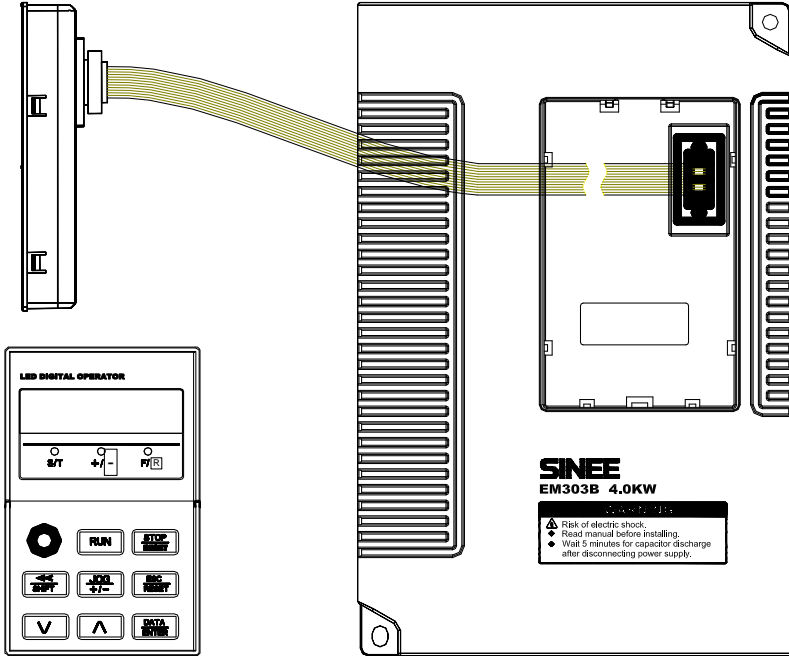

Figure 3-22 Disassemble the Keypad and Connect Extension Keypad Wire

To prevent foreign bodies from entering the inverter, please assemble a keypad window cover (as shown in Figure 3-23) at the front cover of inverter after the keypad has been taken out.

Assembling method: Please put the cover in the keypad window as per the direction of the arrow in Figure 3-24. In order to lock the cover, please fold four flanges on the back of the cover with a pair of pliers.

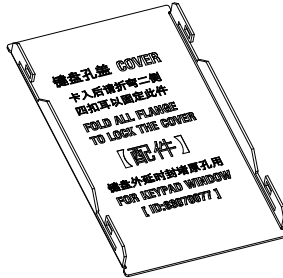

Figure 3-23 Keypad Window Cover

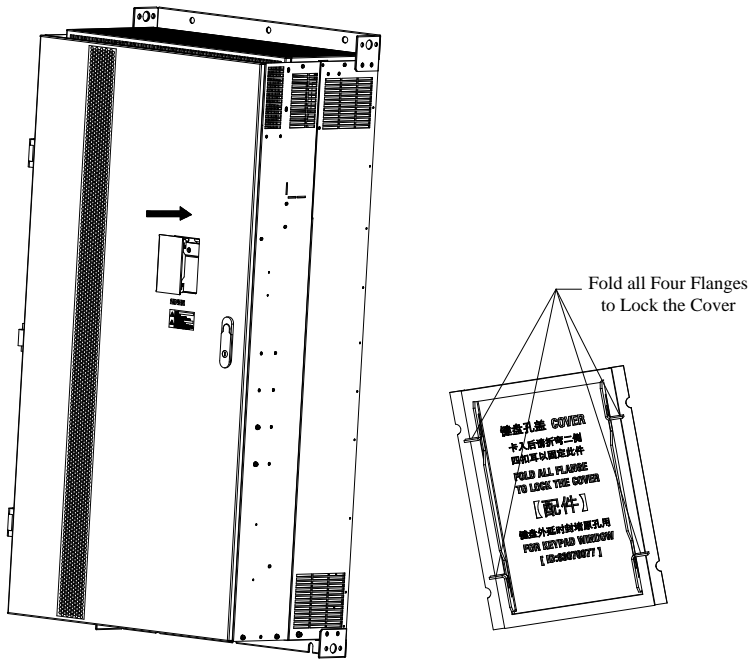

Figure 3-24 Assemble Keypad Window Cover

3.5 Wiring Check

Perform the following checks after wiring has been completed:

- If wiring is correct.
- If anything is left in inverter like screw, or wire clippings.
- If the screw is loose.
- If the bare wire on one terminal connects to other terminals.

4 Keypad Operation

4.1 Type and Function of Keypad







EM303B keypad consists of 5-bit LED display, operation buttons and analog potentiometer. As shown in Figure 4-1.





EM303B can perform function setting, status monitoring, fault monitoring, start/stop control, and jog operation with the help of keypad.



Figure4-1 LED Keypad

Table 4-1 Name and function of each button on the keypad





Part	Name	Function
	Left Shift	Select the bit of setting parameters. Select the row of monitoring parameter in operation.
	Reset/Escape	Reset previous status. Escape from editing the present parameter. Return previous menu.
	Button for Multi-functional programming	For programmable JOG or forward/reverse selection
	ENTER	Save edited parameter of present function code. For entering sub-menu.
	RUN	In keypad control mode, press the button to start inverter.
	STOP/RESET	In keypad control mode, press the button to stop inverter. Reset setting status from fault status when in fault status.
	LED	Display function setting, running monitoring, fault monitoring codes and parameters.

Part	Name	Function
	UP	Select function parameter, menu or increase the value of setting parameters, and increase the present effective reference numeric input data.
	DOWN	Select function parameter, menu or reduce the value of setting parameter, and reduce the present effective reference numeric input data.
	Status Indicator	<p>RUN:Green On: the inverter is running. Flashing: the inverter is stopping.</p> <p>STOP: Red On: fault occurs.</p> <p>S/T: Red Off: in speed control mode On: in torque control mode</p> <p>+/-: Red Off: + positive input signal On: - negative input signal</p> <p>F/R: Red Off: output frequency\geq0, forward On: output frequency$<$0, reverse.</p>
	Analog Potentiometer	Regulate speed as per input analog value.

4.2 LED Keypad Operation Mode

6 keypad operation modes of EM303B: function setting, parameter copy, operation monitoring, fault monitoring, jog running, and start/stop. Keypad operation modes are shown in Table 4-2.

Table 4-2 Keypad Operation Modes

Keypad Operation Mode	Key Function
Function Setting	<ol style="list-style-type: none"> 1. Display, edit, save, reset and lock the function code and its parameters. 2. Reset default of the parameters. 3. Select relevant parameter when the inverter is running.
Function Parameter Copy	<ol style="list-style-type: none"> 1. Upload parameter: Upload the parameters saved in the inverter to keypad. 2. Download parameter: Download the parameters saved in the keypad to inverter. <p>Combine above two modes to copy parameters easily and quickly for multi-inverter.</p>
Running Monitoring	<ol style="list-style-type: none"> 1. Randomly select function parameters C0-00 ~ C0-31 display when the inverter is running.
Fault Monitoring	<ol style="list-style-type: none"> 1. Fault details. 2. Output frequency, DC bus voltage, output current, running direction, and running status when fault occurs. 3. The last 3 faults.
Jog	Press  in setting status, the inverter runs as per the setting frequency. Release  , the inverter will stop.
Start/Stop	In keypad start/stop mode, press  and then release, inverter starts to run. Press  in operation status, inverter stops.

Function setting, operation monitoring and fault monitoring are operated by menu setting. Start/stop, jog and keypad numeric potentiometer are operated by single button.

Editing Parameter

- Follow the viewing procedures to enter the function code first, and then edit the parameter as per the procedures shown in Figure 4-5.
- No matter it is in function setting status or operation status, after entering parameter editing status, LSB(on the right) flashing refers to that editing the parameter is permitted. If LSB does not flash, it indicates that editing the parameter is prohibited.
- Please note that when editing the value of lower bits, if pressing Δ/∇ , the bit will carry automatically after the present selected bit reaches its maximum value. For the function code as F4-13 which needs to be set by bit, if pressing Δ/∇ , the bit will not carry automatically after the present selected bit reaches its maximum value.

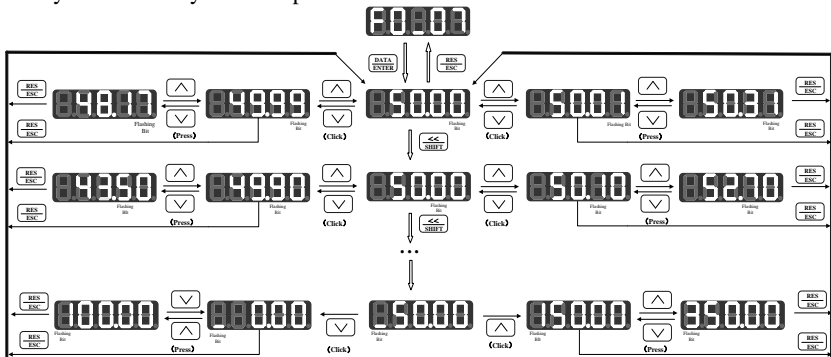

Figure 4-5 Procedures of Editing Parameter

Remarks:

CLICK in Figure 4-5 refers to press the button once and release it very quickly.

PRESS in Figure 4-5 refers to press the button for a long time to edit the parameter.

Saving and Resetting parameter

- Press DATA ENTER to save the edited parameter.
- If there is an unexpected editing, please press RES ESC , and then LSB (on the right) flashes, press RES ESC again to return previous menu, the parameter will reset to previous value and would not be changed. But press DATA ENTER , the edited parameter will be saved, and return previous menu. Or editing the parameter as the original value, and then press DATA ENTER again.
- Take F0-09 for instance, its original parameter value is 0, save or reset the parameter as per the procedures shown in Figure 4-6.

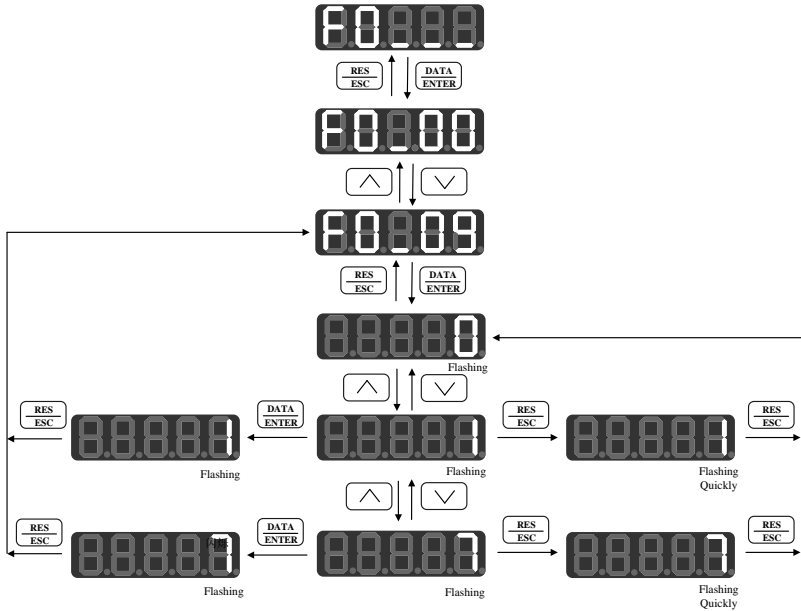

Figure 4-6 Procedures of Saving and Resetting Parameter

Saving Parameters of Relevant Function Code

Because there are correlations between some parameters, the relevant parameters will be edited and saved when corresponding function code has been edited and saved.

The function codes which have correlations:

1. Maximum frequency (F0-16)

The frequencies related to inverter's operation < F0-16(Maximum frequency). When editing and saving the maximum frequency, if the other relevant frequencies > the maximum frequency, inverter will limit the relevant frequency as the maximum frequency. If they are less than the maximum frequency, the relevant frequencies remain unchanged.

The function codes are correlative with each other: F0-07 Primary numeric setting frequency setting, F0-17 upper limit frequency, F0-18 lower limit frequency, and F3-00~F3-14 Preset speed setting.

2. Customer defined V/F curve setting

The function code of customer defined V/F curve setting: Fd-05~Fd-08, the correlation of them: $0 \leq Fd-05 \leq Fd-06 \leq Fd-07 \leq Fd-08 \leq F1-04$.

3. Upper/Lower limit frequency (F0-17, F0-18)

$F0-17(\text{Upper Limit Frequency}) \geq F0-18(\text{Lower Limit Frequency})$

4. Skip frequencies (F6-16, F6-18, F6-20)

$F6-16 \leq F6-18 \leq F6-20$

5. Permission of Motor Forward/Reverse

F0-24=0 Reverse permitted

Motor's running direction is set by F0-08, or controlled by terminal F/R.

F0-24=1 Reverse prohibited

Motor can only run in one direction. F0-08 parameters are disabled, and terminal F/R is off.

6. Analog Voltages (Fd-01~Fd-04)

Fd-01≤Fd_02≤Fd-03≤Fd-04

7. Parameter Setting Mode

If inverter is in running status, it is only permitted to edit or block the parameters. Default reset is prohibited.

4.2.4 Operation Monitoring

When inverter is running (including the process of stopping), LED display will display the data of parameters in C0 group.

Inverter enters operation monitoring code at start, and monitors the operational status of inverter in real-time. Please select a code from C0-00 ~C0-31 in operation monitoring sub-menu, view and monitor its parameter. For instance, see Figure 4-7 for procedures of viewing code C0-08 (Estimated feedback frequency) when inverter is running.



Figure 4-7 Procedures for Viewing and Editing Operation Monitoring Parameters

4.2.5 Keypad Potentiometer

If the speed setting mode of inverter is in VP keypad potentiometer setting mode, when F0-06=1, the setting frequency value can be adjusted by adjusting keypad potentiometer.

4.2.6 Shortcut Key Operation

When inverter is in speed control mode (F0-03=0), and keypad display is the data of C0 group monitoring code. Pressing \uparrow or \downarrow , the value of F0-07 (primary numeric frequency) will increase or decrease automatically. When releasing \uparrow or \downarrow , the display will return C0 group monitoring code.

When inverter is in torque control mode (F0-03=1), and keypad display is the data of C0 group monitoring code. Pressing \uparrow or \downarrow , the value of F5-12 (primary numeric torque) will increase or decrease automatically. When releasing \uparrow or \downarrow , the display will return C0 group monitoring code.

4.2.7 Fault Monitoring

When fault occurs, inverter will enter fault monitoring status (The shared fault code can be viewed by FE-20~ FE-22.) See Table 4-3 for LED displays.

Table 4-3 Fault Status Monitoring Data

Fault Code	Display	Fault
E0-00	00	No fault
	5C	Drive failure/Output Short circuit/EMC fault
	HOC	Instantaneous overcurrent
	SOE	Stable overcurrent
	HOU	Instantaneous overvoltage
	SOU	Stable overvoltage
	SLU	Stable undervoltage/SOFT Soft-start failure
	ILP	Input phase loss
	OL	OL inverter overload/OL1 motor overload (All displayed as OL)
	OH	Overheat
	OLP	Output phase loss
	EtE	External fault
	ESL	PID feedback loss/SPI communication fault/SCIfault
	INP	Internal fault
	EEJ	Inverter EEPROM failure
	EEU	Keypad EEPROM failure
	SLP	Autotuning cancelled
SFE	Autotuning coast-to-stop	
E0-00	SrE	Stator resistance error
	SiE	Idling current error
E0-01	XXX	Output Frequency at Fault
E0-02		Output Current at Fault
E0-03		DC Bus Voltage at Fault
E0-04		Running Direction at Fault
E0-05		Running Status at Fault
E0-06		Stall Status at Fault
E0-07		Working Time at Fault
E0-08~E0-15	The same	The 1 st Most Recent Fault
E0-09~E0-23	Function as	The 2 nd Most Recent Fault
E0-24~E0-31	E0-01~E0-07	The 3 rd Most Recent Fault

Select a code from E0-00~E0-31 to view its parameter on sub-menu of fault monitoring. For instance, see Figure 4-8 for viewing procedures.

Referring to Figure 4-8, press \triangle or \sphericalangle in fault monitoring status to view each fault status, and switch to E0 group fault code to view the last 3 faults status by pressing $\left[\begin{smallmatrix} \text{RES} \\ \text{ESC} \end{smallmatrix} \right]$.

After fault is cleared, pressing $\left[\begin{smallmatrix} \text{STOP} \\ \text{RESET} \end{smallmatrix} \right]$ will enable inverter to return initial power-on status from fault status.

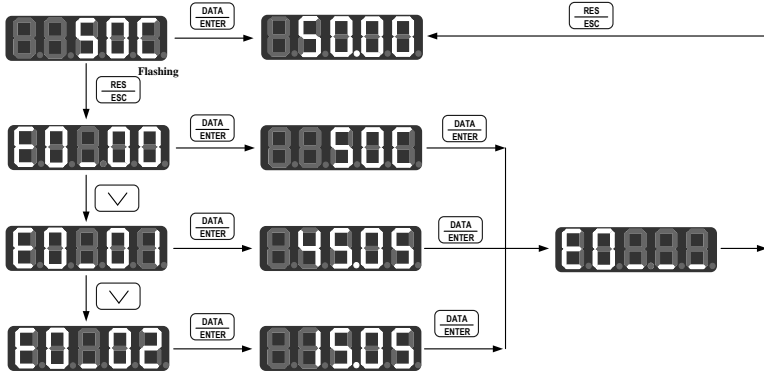







Figure 4-8 Procedures for Viewing Fault Monitoring Code

4.2.8 Multi-functional Button

When F0-21=0, inverter runs as per setting jog frequency when pressing , and will stop immediately when releasing .

When F0-21=1, the running direction of forward /reverse will be switched when pressing .

4.2.9 Start/Stop

If F0-04=1, start/stop of inverter is selected as keypad control mode. When pressing  and released, inverter starts to run. In operation status, inverter will stop immediately when pressing .

4.2.10 Switching Monitoring Display Code

If inverter is running or in ramp-to-stop status, and the present selected function code varies with the status of inverter (F4-18=1), press  for 1.5 seconds, the monitoring display code will vary with the setting values of F4-20~F4-23.

4.2.11 Display of Scientific Notification

If the display data of F0-00 or C0-00 is more than 5 bits, LED will display in scientific notification. For instance: if the speed is 180000rpm, LED display is  which refers to 180×10^3 .

5 Trial Operation

5.1 Trial Operation Procedures

Table 5-1 Procedures of Trial Operation

Procedure		Working Scope
Installation		Check inverter's rated power, and install the inverter as per the requirements stated in Chapter 2.
Wiring the Inverter		Wiring as per the requirements stated in Chapter 3.
Check Before Power-on		<ol style="list-style-type: none"> 1. Be sure the input voltage of power supply matches the rated voltage of inverter. 2. The input power supply circuit connects to a breaker 3. The inverter is grounded. 4. Power supply cable is connected to input terminals R, S and T of the inverter correctly 5. Motor is connected to output terminals U, V, and W of the inverter correctly. 6. Correct control circuit wiring. 7. External switch is at right status. 8. Motor is disconnected from the mechanical system when idling.
Check at Power-on		<ol style="list-style-type: none"> 1. Check if there is unexpected noise, odd smell, or smoke with inverter. 2. When power is on, the keypad display is normal, no fault and alarming. 3. Turn off the power immediately if any emergency, and check as per the instruction in Chapter 9.
Parameter Setting		After the initial operation of inverter, maintenance or motor replaced, reset the parameters as defaults, and then conduct following operations.
Input Correct Motor Nameplate Parameter		Input and confirm the parameters listed on motor nameplate. Otherwise, serious damage may occur in operation.
Setting Protection Parameter of Motor and Inverter		Set correct limit parameters, protection parameters and protection modes of inverter and motor, mainly as: maximum frequency, upper-limit frequency, lower-limit frequency, lower-limit frequency running time, fault retry control, relay fault output.
Autotuning Motor Parameter		<ol style="list-style-type: none"> 1. Obtain correct motor parameters by autotuning motor parameter before the initial operation in selecting vector control mode. 2. Use stationary autotuning motor parameter if motor cannot disconnect the load. 3. Do not autotune motor parameters if the motor is running.
Setting Operation Control Parameter	General Parameter	Set rotational direction, F/R control, acceleration/deceleration time, control mode, star/stop mode, and input mode directly based on driving system working conditions.
	V/F Control	Set parameters of V/F curve scaling, torque boost, slip compensation, and AVR function based on load needs.
	Vector Control	Set parameter of regulator and torque control, and setting parameters based on load conditions.
Idling Trial Operation Check		<p>When motor is idling, start inverter in keypad or terminal control mode, check and confirm the running status of drive system.</p> <ol style="list-style-type: none"> 1. Motor: stable operation, normal rotation, correct rotational direction, normal acceleration/deceleration process, no unexpected vibration, noise or odd smell. 2. Inverter: correct data displayed on the control panel, fans and relays working

			stably, no unexpected vibration or odd smell. 3. Turn off the power immediately if anything unexpected.	
On-load Trial Operation Check			1. If idling check is normal, connect the drive system to load. 2. Turn on the inverter by terminal or keypad, increase load directly, and monitoring the operation of system when connected to load. 3. Turn off the power immediately if anything unexpected.	
Normal Operation	Basic Operation		Inverter can conduct basic operation such as normal start, operation, stop, forward/reverse, and etc. Otherwise, please check if input and start/stop function codes are accurately set.	
	Advanced Operation	Speed Control	After setting program operation codes, system can operate in moncycle or recycle mode. Please check program operation codes if anything unexpected.	
		Program Operation PID Operation	Customer can set PID process control channel and PID regulator parameters to control industrial process according to the drive system demand.	
	Torque Control		Control the output torque based on the input torque command value.	
	Performance Setting	Speed Search		The inverter will automatically detect motor's rotational status at start, and switch to operation smoothly to reduce start-up shock.
		S-Curve Acceleration/Deceleration		Mainly used for the drive system with big inertia and the application which is sensitive to acceleration, to reduce mechanical shock and avoid system vibration.
		DC Brake		Input DC current to the running motor to generate brake torque before start-up or at stop, it makes the motor stop quickly.
Special Terminal Control		EM303B provides multiple programmable input/output terminals which can connect external controller to satisfy various applications.		

5.2 Trial Operation Precautions

5.2.1 Turning on the Power

Checks before power-on:

- Voltage of power supply: 3-phase 380VAC, 50Hz
- Connect the input power supply cable to the input terminals R, S, and T of inverter
- Connect the output terminals U, V, and W of inverter to the input terminals of motor
- All control circuit terminals are connected to correct control device, and terminals shall be off.
- Motor is idling.
- Turn the power on after all above settings have been confirmed.
 - \oplus \ominus are the output terminals of inverter's DC bus voltage, ⊥ is ground terminal, PB is wiring terminal of braking resistor. Any damage resulted from incorrect wiring shall not in warranty.

5.2.2 Check at Power-on

After the inverter starts up, the present working status and parameters will be displayed on the keypad. See Chapter 9 if anything unexpected displayed on keypad.





5.2.3 Idling Operation

When motor is idling without mechanical load, the inverter is in keypad or terminal control mode, try to run the motor. The idling trial operation procedures as shown in followings:

● **Setting Reference Frequency**

The default of inverter reference frequency is keypad VP potentiometer regulation. Before trial operation, please confirm the setting frequency of F0-00, and set the expected reference input frequency through VP potentiometer.

● **Starting the Inverter**

1. In function setting status, press , inverter starts up as per setting value of F0-11(The default is 5.00Hz), and motor runs as per the direction set presently, please monitoring if it runs in a correct direction.
2. Press  on the keypad or turn the start terminal on, the motor runs to the setting frequency of F0-00 displayed.
3. When reverse terminal is on, the motor reverses to setting frequency.
4. Press   to adjust motor speed during running process (See 4.2.6 for reference.).
5. Press  to enter ramp-to-stop status, the speed of motor decreases until the motor stops.

● **Operation Status Monitoring**

1. Change input frequency or rotation direction, and monitor if there is vibration or unexpected noise with the motor or not.
2. Check if inverter runs stably.

5.2.4 On-Load Operation

After idling operation of motor is succeeded, please connect motor to the mechanical load for a trial operation.

● **Connecting Motor to Mechanical Load**

1. After motor stops, turn off the power of inverter, and connect the motor to mechanical load.
2. Tighten up screw to locate the mechanical load onto the motor shaft.

● **Starting up the Inverter**

1. Start up the inverter in the same way as that in idling operation.
2. Set the frequency about 1/10 of the normal running speed.
3. Get ready for pressing  in case of anything unexpected.

● **Operation Status Monitoring**

1. Monitor that the motor runs in the correct direction.
2. Increase frequency setting only after load mechanism is stable when running at a low speed.
3. Change the input frequency or rotation direction of motor, and monitor whether there is vibration or unexpected noise with motor or not.
4. Monitor the parameters of C0-12 or C0-13 in running, and confirm whether the output current of the inverter is normal.

6 Parameter Table

6.1 Format of Parameter Tables

17 groups of parameter of EM303B: F0, F1, F2, F3, F4, F5, F6, F7, F8, F9, FA, Fb, FC, Fd, FE, C0, and E0, 32 items in each group.

F0~FE are function setting parameters which consist of two sections.

Section 1: F0~F5, general parameters.

Section 2: F6~FE are advanced parameters.

Group C0 are status monitoring parameters.

Group E0 are fault monitoring parameters.

When F0-27=0, the inverter only displays the parameters of Group F0~F5, C0, and E0.

When F0-27=1, the inverter displays all parameters.

Column 1: the number of the parameter.

Column 2: the function of parameter.

Column 3: the range of parameter.

Column 4: the parameter unit.

Column 5: the parameter default. For instance, XXX represents that the parameter default varies with the power ratings of inverter.

Column 6: the type of parameter (whether the parameter is editable or not).

Details shown as followings:

“●” : Parameter editing is permitted when the inverter is running.

“○” : Parameter editing is prohibited when the inverter is running.

“X” : The parameter is read only.

Unit and Its Abbreviation

Hour	Hour	m	Meter	%	Percentage*	SQRT	Square Root
min	Minute	mm	Millimeter	rpm	Revolutions per minute	A	Ampere
S	Second	Hz	Hertz	MAX	Maximum	V	Voltage
mS	Millisecond	kHz	Kilohertz	MIN	Minimum	SECT	Program Section
mH	Millihenry	kW	Kilowatt	bps	Bits per second		

★The basic value of percentage is the rated value.

6.2 Parameter Table

Section 1 General Parameters

6.2.1 F0 Group: General Parameters

No.	Function	Range	Unit	Default	Type	S/N
F0-00 (L)	Speed Reference Input	Frequency: 0.00~Fmax/0.0~	Hz	0.00/0	X	0
	Monitoring	Fmax				
F0-01 (H)	Torque Reference Input	Speed: 0~F*Customer defined	rpm	0.0/0	X	1
	Monitoring	scaling Torque input: 0.00~Limited torque	%	0.00		

User Manual
EM303B General Purpose Inverter

No.	Function	Range	Unit	Default	Type	S/N
F0-02	Drive Control Mode	0: V/F open loop Control 1: Not used 2: SVC0 3: SVC1		2	○	2
F0-03	Reference Input Control Mode	0: Speed input 1: Torque input(F0-02=3)		0	○	3
F0-04	Start/Stop Control Options	0: Keypad 1: Terminal 2: RS485		0	○	4
F0-05	Terminal Start/Stop Control Options	0: RUN-Run, F/R-Forward/Reverse 1: RUN-Forward, F/R- Reverse 2: RUN-NO forward, Xi-NC stop, F/R-NO reverse 3: RUN-NO run, Xi-NC stop, F/R- Forward/Reverse		0	○	5
F0-06	Regular Speed Setting Mode	0: Primary Numeric Frequency 1: VP 2: VS 3: IS 4: Not Used 5: $K3*VS+K4*IS$ 6: $K3*VS+K5*VF$ 7: $K4*IS+K6*IF$ 8: $MAX\{K3*VS,K5*VF\}$ 9: $MAX\{K4*IS,K6*IF\}$ 10: $K1*VP+K2*(K3*VS+K4*IS+K5*VF+K6*IF-K8*5V)$		1	○	6
F0-07	Primary Numeric Frequency Setting	0.00~Fmax	Hz	0.00	●	7
F0-08	Motor Running Direction	0: Forward 1: Reverse		0	●	8
F0-09	Acceleration Time 1	0.00~600.00	S/min	15.00	●	9
F0-10	Deceleration Time 1	0.00~600.00	S/min	15.00	●	10
F0-11	Jog Numeric Frequency	0.00~Fmax/0.0~Fmax	Hz	5.00	●	11
F0-12	Jog Acceleration Time	0.00~600.00	S/min	15.00	●	12
F0-13	Jog Deceleration Time	0.00~600.00	S/min	15.00	●	13
F0-14	Carrier Frequency	0kW~9kW:1.000~16.000 9kW~37kW:1.000~8.000 37kW~110kW:1.000~4.000 110kW~400kW:1.000~3.000	kHz	2.000	●	14

User Manual
EM303B General Purpose Inverter

No.	Function	Range	Unit	Default	Type	S/N
F0-15	Torque Boost	0: Automatic torque boost 1~10: Fixed torque boost curve 11~20: Oil pump motor boost curve 21~30: Synchronous motor boost curve 31~34: Blower/water pump boost curve 35: Customer defined V/F curve scaling		35	●	15
F0-16	Maximum Frequency	Fmax:20.00~600.00	Hz	50.00	○	16
F0-17	Upper Limit Frequency	Fup: Fdown~Fmax	Hz	50.00	○	17
F0-18	Lower Limit Frequency	Fdown: 0.00~Fup	Hz	0.00	○	18
F0-19	Start Mode Options	0: Normal start 1: Speed search start		0	○	19
F0-20	Stop Mode Options	0: Ramp to stop 1: Coast to stop		0	○	20
F0-21	 Function Setting	0: Jog running 1: Positive/Negative input switching 2: Disabled		0	○	21
F0-22	Speed Monitoring Options	0: Frequency Hz 1: Speed rpm		0	●	22
F0-23	Customer Defined Scaling	0.01~600.00		30.00	●	23
F0-24	Forward/Reverse Control Mode	0: Reverse Permitted 1: Reverse Prohibited		0	○	24
F0-25	F/R Deadband Time	0.00~600.00	S	0.00	○	25
F0-26	Primary Speed Setting Mode	0: Regular speed setting mode 1: Special speed setting mode 2: Process PID input mode		0	○	26
F0-27	Menu Mode Options	0: Basic menu mode 1: Advanced menu mode		0	○	27
F0-28	Default Control	0: Disabled 1: Defaults Reset		0	○	28
F0-29	Parameter Setting Control	0: Parameter setting permitted 1: Parameter lock 0 2: Parameter lock 1		0	○	29
F0-30	Inverter Model	0: Model G 1: Model P		0	○	30
F0-31	User Password	0~65535		XXXXXX	○	31

6.2.2 F1 Group: Motor Parameters

No.	Function	Range	Unit	Default	Type	S/N
F1-00	Motor Type	0: AC induction motor 1: Not used		0	○	32
F1-01	Motor Rated Power	0.40~480.00	kW	XXXX	○	33
F1-02	Motor Rated Voltage	60~660	V	XXX	○	34
F1-03	Motor Rated Current	0.1~1500.0	A	XXXX	○	35
F1-04	Motor Rated Frequency	20.00~600.00	Hz	XXXX	○	36
F1-05	Motor Rated Speed	1~60000	rpm	XXXX	○	37
F1-06	Motor Wiring Mode	0: Y 1: Δ		X	○	38
F1-07	Motor Rated Power Factor	0.50~0.99		X	○	39
F1-08	Idling Excitation Current I0	0.1~1500.0	A	XXXX	○	40
F1-09	Rated Torque Current	0.1~1500.0	A	XXXX	×	41
F1-10	Stator Resistance R1	0.001~60.000	Ω	XXXX	○	42
F1-11	Rotator Resistance R2	0.001~60.000	Ω	XXXX	○	43
F1-12	Stator& Rotor Leakage Inductance Ls	0.1~3000.0	mH	XXXX	○	44
F1-13	Stator& Rotor Mutual Inductance Lm	0.1~3000.0	mH	XXXX	○	45
F1-14	Motor Efficiency	30.0~99.0		XXX	○	46
F1-15	Autotuning Parameters	0: No autotuning 1: Stationary autotuning 2: Rotational autotuning		0	○	47
F1-16	Inverter Address	1~247, 0: Broadcasting Address		1	○	48
F1-17	Communication Bit Rate	0: 4800 1: 9600 2: 19200 3: 38400	bps	1	○	49
F1-18	Communication Parity Mode	0: No parity 1+8+1 for RTU 1: Even parity 1+8+1+1 for RTU 2: Odd parity 1+8+1+1 for RTU		0	○	50
F1-19	Master-slave Communication Mode	0: The inverter is the slave 1: The inverter is the master		0	○	51
F1-20	Receiving Address of Slave Inverter	0:Primary Numeric Frequency (F0-07) 1:Auxiliary Numeric Frequency(F9-06)		0	○	52
F1-21	Inverter Receiving Proportion Coefficient	0.00~600.00	%	100.00	●	53
F1-22	Analog Input Gain K1	0.00~600.00	%	100.00	●	54
F1-23	Analog Input Gain K2	0.00~600.00	%	0.00	●	55
F1-24	Analog Input Gain K3	0.00~600.00	%	100.00	●	56

No.	Function	Range	Unit	Default	Type	S/N
F1-25	Analog Input Gain K4	0.00~600.00	%	0.00	●	57
F1-26	Analog Input Gain K5	0.00~600.00	%	0.00	●	58
F1-27	Analog Input Gain K6	0.00~600.00	%	0.00	●	59
F1-28	Analog Input Gain K7	0.00~600.00	%	0.00	●	60
F1-29	Analog Input Gain K8	0.00~600.00	%	0.00	●	61
F1-30	Communication Overtime	0.0~60.0 (0.0: Disabled)	S	0.0	●	62
F1-31	Master Communication Transmitting Data	0: Input frequency 1: Output frequency 2: Primary Numeric Frequency 3: Auxiliary Numeric Frequency 4: VP 5: VS 6: VF 7: IS 8: IF		0	●	63

6.2.3 F2 Group: Input/Output Terminal Parameters

No.	Function	Range	Unit	Default	Type	S/N	
F2-00	Multi-function Input Terminal X1-RUN	See Table 6-1 Functions of Numeric Multi-function Input Terminals		1	○	64	
F2-01	Multi-function Input Terminal X2-F/R			2	○	65	
F2-02	Multi-function Input Terminal X3-D1			3	○	66	
F2-03	Multi-function Input Terminal X4-D2			4	○	67	
F2-04	Multi-function Input Terminal X5-D3			5	○	68	
F2-05	Multi-function Input Terminal X6-FRS			9	○	69	
F2-06	Multi-function Input Terminal X7-RST			10	○	70	
F2-07	Not used						71
F2-08	VS Input Function Defining				0	○	72
F2-09	IS Input Function Defining				0	○	73
F2-10	VF Input Function Defining				0	○	74
F2-11	IF Input Function Defining				0	○	75
F2-12	Multi-function Output Terminal Y1		See Table 6-2		0	○	76
F2-13	Multi-function Output Terminal Y2		Functions of Numeric		1	○	78
F2-14	Relay Output Terminal R1	Multi-function Output		9	○	79	
F2-15	Not Used	Terminals				80	
F2-16	Analog Output Terminal M0	See Table 6-3 F2-16~F2-17	%	0	○	81	
F2-17	Analog Output Terminal M1	Analog Output Full Scale	%	6	○	82	
F2-18 ~F2-21	Not Used					83 ~86	
F2-22	M0 Output Lower Limit	0.00~100.00	%	0.00	●	87	
F2-23	M0 Output Upper Limit	0.00~100.00	%	100.00	●	88	
F2-24	M0 Output Gain	0.00~300.00	%	95.00	●	89	
F2-25	M1 Output Lower Limit	0.00~100.00	%	0.00	●	90	

No.	Function	Range	Unit	Default	Type	S/N
F2-26	M1 Output Upper Limit	0.00~100.00	%	100.00	●	91
F2-27	M1 Output Gain	0.00~300.00	%	95.00	●	92
F2-28 ~F2-31	Not used					

Table 6-1 Functions of Numeric Multi-function Input Terminals

No.	Function	No.	Function
0	Disabled	26	Not Used
1	RUN-run	27	Switching Speed Input Setting to Primary Speed Setting
2	F/R Forward/Reverse	28	Switching Speed Input Setting to Auxiliary Speed Setting
3	Preset Speed Terminal 1	29	Switching Primary Speed Setting to Regular Speed Setting
4	Preset Speed Terminal 2	30	Switching Regular Speed Input Setting to Numeric Speed Input Setting
5	Preset Speed Terminal 3	31	Switching Jog Input Setting to Jog Numeric Speed Input Setting
6	Preset Speed Terminal 4	32	Not Used
7	Acceleration/Deceleration Time Terminal 1	33	Not Used
8	Acceleration/Deceleration Time Terminal 2	34	Not Used
9	Coast to Stop	35	Switching Regular Torque Input Setting to Numeric Torque Input Setting
10	Inverter Fault Reset	36	Not Used
11	Forward Jog FJOG	37	PID Positive/Negative Setting Switch
12	Reverse Jog RJOG	38	Not Used
13	Terminal UP	39	Not Used
14	Terminal DOWN	40	Not Used
15	UP/DOWN Clearing	41	Not Used
16	Acceleration/Deceleration Prohibited	42	Not Used
17	Ramp to Stop	43	Not Used
18	3-wire Sequence Stop Control (Pulse Stop)	44	Preset Current Limit Terminal 1
19	Not Used	45	Preset Current Limit Terminal 2
20	Switching Drive Control Mode to V/F Control Mode	46	Preset Current Limit Terminal 3
21	Switching Run Command to Terminal Control Mode	47	Start Wobulation Operation
22	Run Command Input 0	48	Not Used
23	Run Command Input 1	49	Program Operation Reset(Reset Time,Pulse)
24	Switching Input Control Mode to Speed Control Mode	50	Alternate Motor Switching Command
25	Switching Input Control Mode to Torque Control Mode	51	External Fault Input

Table 6-2 Functions of Numeric Multi-function Output Terminals

No.	Function	No.	Function
0	Inverter Runs(Enabled at Running)	17	Overload Alarming Output
1	Frequency Reach Range FAR(Enabled at running)	18	Overvoltage Stall
2	Output Frequency Detection Range FDT1(Enabled at running)	19	Current Limit
3	Output Frequency Detection Range FDT2(Enabled at running)	20	Frequency Zero Speed Detection(Output Frequency Detection)
4	Output Frequency Detection Range FDT1(Disabled at JOG)	21	Not Used
5	Output Frequency Detection Range FDT2(Disabled at JOG)	22	Motor 2 Enabled
6	Forward/Reverse(Enabled at Running)	23	Setting running time is up
7	Frequency Input/Output Balance (Enabled at Running)	24	Not Used
8	JOG	25	Not Used
9	Inverter Fault	26	Inverter is ready for running
10	Upper Limit Frequency Reach	27	Not Used
11	Lower Limit Frequency Reach	28	FDT1 LowerBounds(Pulse)
12	Not Used	29	FDT2 LowerBounds (Pulse)
13	Not Used	30	FDT1 LowerBounds(voidwhen JOG, Pulse)
14	Analog Detection Range ADT1	31	FDT2 LowerBounds(voidwhen JOG, Pulse)
15	Analog Detection Range ADT2	32	ILP Fault
16	Analog Detection Range ADT3		

Table 6-3 F2-16~F2-17 Analog Outputs Full Scales

No.	Signal	Full Scale(100.0%)	No.	Signal	Full Scale(100.0%)
0	Output Frequency	Fmax	11	IS	20mA
1	Input Frequency	Fmax	12	IF	20mA
2	Synchronous Frequency	Fmax	13	Output torque (actual value)	2 times motor rated torque
3	Output torque (absolute value)	2 times motor rated torque	14	+10V	+10V
4	Not Used		15	PID Input	PID Maximum Scale
5	Not Used		16	PID Feedback	PID Maximum Scale
6	Output Current	2 times inverter rated current	17	Not Used	
7	Output Voltage	1.5 times inverter rated voltage	18	Not Used	
8	VP	5.00V	19	DC Bus Voltage	1.5 times rated input voltage
9	VS	10.00V	20	Output Power	inverter rated power
10	VF	10.00V	21	Estimated frequency /Output torque	Fmax/motor rated torque

6.2.4 F3 Group: Preset Speed Operation Parameters

No.	Function	Range	Unit	Default	Type	S/N	
F3-00	Preset Speed 1	0.00~Fmax/0.0~Fmax	Hz	0.00	●	96	
F3-01	Preset Speed 2	0.00~Fmax/0.0~Fmax	Hz	5.00	●	97	
F3-02	Preset Speed 3	0.00~Fmax/0.0~Fmax	Hz	10.00	●	98	
F3-03	Preset Speed 4	0.00~Fmax/0.0~Fmax	Hz	15.00	●	99	
F3-04	Preset Speed 5	0.00~Fmax/0.0~Fmax	Hz	20.00	●	100	
F3-05	Preset Speed 6	0.00~Fmax/0.0~Fmax	Hz	25.00	●	101	
F3-06	Preset Speed 7	0.00~Fmax/0.0~Fmax	Hz	30.00	●	102	
F3-07	Preset Speed 8	0.00~Fmax/0.0~Fmax	Hz	35.00	●	103	
F3-08	Preset Speed 9	0.00~Fmax/0.0~Fmax	Hz	40.00	●	104	
F3-09	Preset Speed 10	0.00~Fmax/0.0~Fmax	Hz	45.00	●	105	
F3-10	Preset Speed 11	0.00~Fmax/0.0~Fmax	Hz	50.00	●	106	
F3-11	Preset Speed 12	0.00~Fmax/0.0~Fmax	Hz	50.00	●	107	
F3-12	Preset Speed 13	0.00~Fmax/0.0~Fmax	Hz	50.00	●	108	
F3-13	Preset Speed 14	0.00~Fmax/0.0~Fmax	Hz	50.00	●	109	
F3-14	Preset Speed 15	0.00~Fmax/0.0~Fmax	Hz	50.00	●	110	
F3-15	Acceleration Time 2	0.00~600.00	S/min	15.00	●	111	
F3-16	Deceleration Time 2	0.00~600.00	S/min	15.00	●	112	
F3-17	Acceleration Time 3	0.00~600.00	S/min	15.00	●	113	
F3-18	Deceleration Time 3	0.00~600.00	S/min	15.00	●	114	
F3-19	Acceleration Time 4	0.00~600.00	S/min	15.00	●	115	
F3-20	Deceleration Time 4	0.00~600.00	S/min	15.00	●	116	
F3-21	Acceleration/Deceleration Time Unit	0: S 1: min		0	○	117	
F3-22	DC Brake Proportion at Start	0.00~30.00, 30.01~250.00	%	100.00	○	118	
F3-23	DC Brake Time at Start	0.00~30.00	S	0.00	○	119	
F3-24	DC Brake Start Frequency at Stop	0.10~60.00/0.1~60.0	Hz	2.00	○	120	
F3-25	DC Brake Proportion at Stop	0.00~30.00, 30.01~250.00	%	100.00	○	121	
F3-26	DC Brake Waiting Time at Stop	0.10~ 30.00	0~15 kW 15~110 kW 110~400 kW	S	0.40 0.70 1.00	○	122
F3-27	DC Brake Time at Stop	0.00~30.00	S	0.00	○	123	
F3-28	Lower Limit Frequency Control	0: Run as per the lower limit frequency 1: Run at zero speed after lower limit frequency running time is up.		0	○	124	
F3-29	Lower Limit Frequency Running Time	0.00~600.00	S	60.00	○	125	
F3-30	Open Loop Slip Compensation	0.00~200.00	%	100.00	●	126	

No.	Function	Range	Unit	Default	Type	S/N
F3-31	Parameter Copy	0: No Copy 1: Upload Parameter (From Inverter to Keypad) 2: Download Parameter (From Keypad to Inverter)		0	○	127

6.2.5 F4 Group: General Parameters of PID

No.	Function	Range	Unit	Default	Type	S/N
F4-00	PID Regular Setting Mode	0: Numeric PID Setting 1: VS 2: IS 3: VF 4: IF 5: VP		0	○	128
F4-01	PID Numeric Setting	0.0~PIDMaximum Scale	V	0.0	●	129
F4-02	PID Feedback Options	0: VF 1: IF 2: VS 3: IS		0	○	130
F4-03	PID Maximum Scale	0.1~6000.0		10.0	●	131
F4-04	Positive/Negative Options of PID Upper/Lower Limit	Ones place: PID Upper Limit Options 0: Positive 1: Negative Tens place: PID Lower Limit Options 0: Positive 1: Negative		10	●	132
F4-05	PID Regulation Setting	0: Positive Setting 1: Negative Setting		0	○	133
F4-06	PID Output Gain	0.00~100.00	%	100.00	●	134
F4-07	Proportional Gain GP	0.00~100.00		0.40	●	135
F4-08	Integral Time GTi	0.00~300.00 0.00: No integration	S	10.00	●	136
F4-09	Differential Time GTd	0.00~100.00	mS	0.00	●	137
F4-10	Integration Function Scale	0.00~100.00	%	100.00	●	138
F4-11	PID Upper Limit	0.00~100.00	%	100.00	●	139
F4-12	PID Lower Limit	0.00~100.00	%	0.00	●	140
F4-13	Menu Display Control 1	Fd FC Fb FA F9 F8 F7 F6		11111111	●	141
		1 1 1 1 1 1 1 1				
		0: No Display, 1: Display				

No.	Function	Range								Unit	Default	Type	S/N
F4-14	Menu Display Control 2	*	*	*	*	*	*	*	FE		00000001	●	142
		0	0	0	0	0	0	0	1				
		0: No Display, 1: Display, *: Not used											
F4-15	Monitoring Reference Options	*	Iq	E-Slip	E-Speed	*	F _s	F _i	F _o		11111111	●	143
		0	0	0	0	0	0	0	0				
		0: Absolute Value, 1: +/-, *: Not used											
F4-16	LCD Language Options	0: Chinese, 1: English									0	○	144
F4-17	Not Used												145
F4-18	If Parameters Change with Inverters Working Status	0: Unchanged 1: Changed									1	○	146
F4-19	Parameter Setting Display	0~575									0	●	147
F4-20	Parameters displayed in the 1 st row in operation	0~575									512	●	148
F4-21	Parameters displayed in the 2 nd row in operation	0~575									514	●	149
F4-22	Parameters displayed in the 3 rd row in operation	0~575									524	●	150
F4-23	Parameters displayed in the 4 th row in operation	0~575									525	●	151
F4-24	Parameters displayed in the 1 st row at stop	0~575									512	●	152
F4-25	Parameters displayed in the 2 nd row at stop	0~575									514	●	153
F4-26	Parameters displayed in the 3 rd row at stop	0~575									524	●	154
F4-27	Parameters displayed in the 4 th row at stop	0~575									528	●	155
F4-28	Not Used												156
F4-29	Not Used												157
F4-30	PID Feedback Loss Detection Value	0.0~PID maximum scale									0.0	○	158
F4-31	PID Feedback Loss Detection Time	0.0~6000.0								S	6000.0	○	159

6.2.6 F5 Group: General Parameters of Vector Control

No.	Function	Range	Unit	Default	Type	S/N
F5-00	Speed Proportional Gain ASR_P1	0.00~100.00	%	15.00	●	160
F5-01	Speed Integral Time ASR_Ti1	0.00~30.00 0.00: No integration	S	0.50	●	161
F5-02	Speed Differential Time ASR_Td1	0.00~10.00	mS	0.00	●	162
F5-03	Speed Proportional Gain ASR_P2	0.00~100.00	%	12.00	●	163
F5-04	Speed IntegralTime ASR_Ti2	0.00~30.00 0.00: No integration	S	0.50	●	164
F5-05	Switching Frequency 0	0.00~Switching Frequency 1	Hz	5.00	○	165
F5-06	Switching Frequency 1	Switching Frequency 0~Fmax	Hz	10.00	○	166
F5-07	Torque Current Acceleration Time	0.000~30.000	S	0.040	●	167
F5-08	Torque Current Deceleration Time	0.000~30.000	S	0.040	●	178
F5-09	Power Torque Current Limit	80.00~250.00	%	165.00	●	169
F5-10	Brake Torque Current Limit	80.00~250.00	%	165.00	●	170
F5-11	Regular Torque Setting	0: Primary Numeric Torque Setting 1: VP 2: VS 3: IS 4: VF 5: IF 6: Not used 7: $K1*VP+K2*(K3*VS+K4*IS+K5*VF+K6*IF-K8*5V)$		0	○	171
F5-12	Primary Numeric Torque Current	0.00~Maximum torque	%	0.00	●	172
F5-13	Torque Direction	0: Positive Torque 1: Negative Torque		0	●	173
F5-14	Upper Limit Frequency Limiting of Torque	0: Upper Limit Frequency 1: $VS*Upper\ Limit\ Frequency$ 2: $IS*Upper\ Limit\ Frequency$ 3: $VF*Upper\ Limit\ Frequency$ 4: $IF*Upper\ Limit\ Frequency$		0	○	174
F5-15	Static friction compensation coefficient	0.00~150.00	%	0	●	175
F5-16	Not Used					176
F5-17	Static friction acting cut-off frequency	0.00~50.00	Hz	2.00	○	177
F5-18 ~F5-19	Not Used					178 ~179
F5-20	Gain of VVF Excitation Current	0~60000		0	●	180

Regulation						
------------	--	--	--	--	--	--

No.	Function	Range	Unit	Default	Type	S/N
F5-21	Integral Time of VVF Excitation Current Regulation	0.00~600.00	mS	0.00	●	181
F5-22	Positive/Negative Torque Control	0: Positive/Negative Torque Permitted 1: Negative Torque Prohibited		0	○	182
F5-23	Positive/Negative Torque Deadband Time	0.00~600.00	S	0.00	○	183
F5-24	Current Loop Gain ACR_P	0.00~10.00	%	0.40	●	184
F5-25	Current Loop Integration ACR_Ti	0.00~300.00	mS	10.00	●	185
F5-26	Closed-loop Slip Compensation Gain	50.00~200.00	%	100.00	●	186
F5-27	Control Mode at Zero Frequency	0: Brake 1: Normal 2: No output		2	○	187
F5-28	Low Frequency Excitation Gain	50.00~150.00	%	100.00	○	188
F5-29	Excitation Gain Kd	100.00~600.00	%	0~9kW 100.00	●	189
		9~30kW 150.00				
		30~55kW 200.00				
		55~75kW 300.00				
		75~110kW 400.00				
		110~400kW 500.00				
F5-30	Set-up Time of Excitation Gain	0.00~10.00	S	0~9kW 0.10	○	190
		9~55kW 0.15				
		55~400kW 0.20				
F5-31	Maximum Torque	50.00~250.00	%	100.00	○	191

6.2.7 C0 Group: Parameters of Monitoring Function

No.	Function	Range	Unit	Default	Type	S/N
C0-00	Output Frequency	0.00~Fup/0.0~Fup	Hz		×	512
C0-01						513
C0-02	Input Frequency	0.00~Fmax/0.0~Fmax	Hz		×	514
C0-03						Torque Upper Limit Frequency
C0-04	Synchronous Frequency	0.00~Fup/0.0~Fup	Hz		×	516
C0-05						517
C0-06	Not Used					518
C0-07	Not Used					519
C0-08	Estimated Feedback Frequency	0.00~Fup/0.0~Fup	Hz		×	520
C0-09						521
C0-10	Estimated Slip Frequency	0.00~Fup/0.0~Fup	Hz		×	522

C0-11					7	523
C0-12	Output Current Percentage	0.00~300.00	%		×	524
C0-13	Effective Output Current Value	0.0~3000.0	A		×	525
No.	Function	Range	Unit	Default	Type	S/N
C0-14	Output Voltage Percentage	0.00~200.00	%		×	526
C0-15	Effective Output Voltage Value	0.0~660.0	V		×	527
C0-16	DC Bus Voltage	0~1200	V		×	528
C0-17	Output torque percentage	0.00~200.00	%		×	529
C0-18	Not Used				×	530
C0-19	Program Operation Section	1~7			×	531
C0-20	Running Time of Present Section of ProgramOperation	0.0~6000.0	S/min		×	532
C0-21	Output Power	0.0~3000.0	kW		×	533
C0-22	PID Input	0.0~PID Maximum Scale			×	534
C0-23	PID Calculation Feedback	0.00~PID Maximum Scale			×	535
C0-24	Torque CurrentInput I_q^*	0.00~200.00	%		×	536
C0-25	Torque CurrentFeedback I_q	0.00~200.00	%		×	537
C0-26	Input Terminal Status	X7 X6 X5 X4 X3 X2 X1			×	538
		0 0 0 0 0 0 0				
C0-27	Output Terminal Status	* * * * R1 Y2 Y1			×	539
		0 0 0 0 0 0 0				
C0-28	VS Input Monitoring	0-10000			×	540
C0-29	IS Input Monitoring	0-10000			×	541
C0-30	VF Input Monitoring	0-10000			×	542
C0-31	IF Input Monitoring	0-10000			×	543

7.1.1 E0 Group: Fault Parameters

No.	Function	Range	Unit	Default	Type	S/N
E0-00	Fault Trips	00: No fault 5C: Drive Fault/OutputShortcircuit/EMC fault HOC: Instantaneous overcurrent HOU: Instantaneous overvoltage SOC: Stable overcurrent SOU: Stable overvoltage SLU: Stable undervoltage/SOFT Soft-start failure LLP: Input phase loss OL: Inverter Overload OL1: Motor Overload(OL &OL1 displayed as OL on the keypad) OH: Overheat		0	×	544

User Manual
EM303B General Purpose Inverter

		<i>OLP</i> : Output phase loss <i>EMt</i> : External fault <i>EEd</i> : Inverter EEPROM failure <i>EEU</i> : Keypad EEPROM failure <i>StP</i> : Autotuning cancelled <i>SFE</i> : Autotuning coast-to-stop <i>SE</i> : Stator resistance error <i>SiE</i> : Idling current error <i>ESL</i> : PID feedback loss/SPI communication fault/SCIfault <i>IP</i> : Internal fault				
E0-01	Output Frequency at Fault	XX.XX	Hz	0.00	×	545
E0-02	Output Current at Fault	XXX.X	A	0.0	×	546
E0-03	DC Bus Voltage at Fault	XXXX	V	0.0	×	547
E0-04	Running Direction at Fault	<i>FoR</i> :Forward <i>rEu</i> : Reverse		0	×	548
E0-05	Running Status at Fault	<i>ACC</i> : Acceleration <i>CDn</i> : Constant Speed <i>dEL</i> : Deceleration		0	×	549
E0-06	Stall Status at Fault	<i>0</i> : Normal <i>Uv</i> : Overvoltage stall <i>OL</i> : Overcurrent stall		0	×	550
E0-07	Working Time at Fault		HOUR	0	×	551
E0-08	The 1 st Most Recent Fault	Fault trips		0	×	552
E0-09	Output Frequency at Fault	XX.XX/XX.X	Hz	0.00	×	553
E0-10	Output Current at Fault	XXX.X	A	0.0	×	554
E0-11	DC Bus Voltage at Fault	XXXX	V	0.0	×	555
E0-12	Running Direction at Fault	<i>FoR</i> :Forward <i>rEu</i> : Reverse		0	×	556
E0-13	Running Status at Fault	<i>ACC</i> : Acceleration <i>CDn</i> : Constant Speed <i>dEL</i> : Deceleration		0	×	557
E0-14	Stall Status at Fault	<i>0</i> : Normal <i>Uv</i> : Overvoltage stall <i>OL</i> : Overcurrent stall		0	×	558
E0-15	Working Time at Fault		HOUR	0	×	559
E0-16	The 2 nd Most Recent Fault	Fault trips		0	×	560
E0-17	Output Frequency at Fault	XX.XX/XX.X	Hz	0.00	×	561
E0-18	Output Current at Fault	XXX.X	A	0.0	×	562
E0-19	DC Bus Voltage at Fault	XXXX	V	0.0	×	563
E0-20	Running Direction at Fault	<i>FoR</i> :Forward <i>rEu</i> : Reverse		0	×	564
E0-21	Running Status at Fault	<i>ACC</i> : Acceleration <i>CDn</i> : Constant Speed <i>dEL</i> : Deceleration		0	×	565
E0-22	Stall Status at Fault	0: Normal		0	×	566

		\overline{U} : Overvoltage stall \overline{I} : Overcurrent stall				
E0-23	Working Time at Fault		HOUR	0	×	567
E0-24	The 3 rd Most Recent Fault	Fault trips		0	×	568
E0-25	Output Frequency at Fault	XX.XX/XX.X	Hz	0.00	×	569
E0-26	Output Current at Fault	XXX.X	A	0.0	×	570
No.	Function	Range	Unit	Default	Type	S/N
E0-27	DC Bus Voltage at Fault	XXXX	V	0.0	×	571
E0-28	Running Direction at Fault	F_{or} : Forward $r\overline{E}u$: Reverse		0	×	572
E0-29	Running Status at Fault	\overline{a} : Acceleration \overline{c} : Constant Speed \overline{d} : Deceleration		0	×	573
E0-30	Stall Status at Fault	$\overline{0}$: Normal \overline{U} : Overvoltage stall \overline{I} : Overcurrent stall		0	×	574
E0-31	Working Time at Fault		HOUR	0	×	575

Section 2 Advanced Parameters

7.1.2 F6 Group: Simple PLC Function

No.	Function	Range	Unit	Default	Type	S/N
F6-00	Program Operation Mode	Ones place: Options of programmable speed operation mode 0: Monocycle 1: Run as per Preset Speed 7 after monocycle 2: Limited times of continuous cycle 3: Continuous cycle Tens place: Not used Hundreds place: Not used Thousands place: Options of restart after operation paused 0: Restart from the section when it paused 1: Restart from Preset Speed 1 Ten thousands place: Program operation time unit 0: S 1: min		00000	○	192
F6-01	Preset Program Operation Section 1	Ones place: Motor running direction options 0: Forward 1: Reverse Tens place: Options of acceleration / deceleration time 0: Acceleration / Deceleration time 1 1: Acceleration / Deceleration time 2 2: Acceleration / Deceleration time 3 3: Acceleration / Deceleration time 4		100	○	193

User Manual
EM303B General Purpose Inverter

		Hundreds place: Saving options at power failure in program operation 0: Not Saved 1: Saved				
F6-02	Preset Program Operation Section 2			100	○	194
F6-03	Preset Program Operation Section 3			100	○	195
No.	Function	Range	Unit	Default	Type	S/N
F6-04	Preset Program Operation Section 4			100	○	196
F6-05	Preset Program Operation Section 5			100	○	197
F6-06	Preset Program Operation Section 6			100	○	198
F6-07	Preset Program Operation Section 7			100	○	199
F6-08	Operation Time T1	0.0~6000.0	S/min	30.0	●	200
F6-09	Operation Time T2	0.0~6000.0	S/min	30.0	●	201
F6-10	Operation Time T3	0.0~6000.0	S/min	30.0	●	202
F6-11	Operation Time T4	0.0~6000.0	S/min	30.0	●	203
F6-12	Operation Time T5	0.0~6000.0	S/min	30.0	●	204
F6-13	Operation Time T6	0.0~6000.0	S/min	30.0	●	205
F6-14	Operation Time T7	0.0~6000.0	S/min	30.0	●	206
F6-15	Speed Cycling Times	1~10000		1	●	207
F6-16	Skip Frequency Point 1	0.00~600.00/0.0~6000.0	Hz	600.00	●	208
F6-17	Skip Frequency Range 1	0.00~20.00/0.0~20.0 0.00/0.0: Disabled	Hz	0.00	●	209
F6-18	Skip Frequency Point 2	F6-16~600.00/F6-16~6000.0	Hz	600.00	●	210
F6-19	Skip Frequency Range 2	0.00~20.00/0.0~20.0, 0.00/0.0: Disabled	Hz	0.00	●	211
F6-20	Skip Frequency Point 3	F6-18~600.00/F6-18~6000.0	Hz	600.00	●	212
F6-21	Skip Frequency Range 3	0.00~20.00/0.0~20.0 0.00/0.0: Disabled	Hz	0.00	●	213
F6-22	Not Used					214
F6-23	Not Used					215
F6-24	Wobulation Operation Mode	Ones place: Wobulation operation control 0: Auto-operation 1: Terminal Control Tens place: Wobulation input mode 0: Wobulation operation started after reached the mid-point 1: Start wobulation operation when its preset time is up		00	○	216
F6-25	Preset Frequency of Wobulation	0.00~Fmax/0.0~Fmax	Hz	0.00	●	217
F6-26	Preset Wobulation Time	0.00~600.00	S	15.00	●	218

F6-27	Upper Limit Frequency of Wobulation	Lower Limit Frequency of Wobulation ~ Fmax	Hz	40.00	●	219
F6-28	Lower Limit Frequency of Wobulation	0.00/0.0 ~ Upper Limit Frequency of Wobulation	Hz	20.00	●	220
F6-29	Jump Frequency of Wobulation	0.00/0.0 ~ (Upper Limit Frequency of Wobulation - Lower Limit Frequency of Wobulation)/2	Hz	5.00	●	221
No.	Function	Range	Unit	Default	Type	S/N
F6-30	Rising Time of Wobulation	0.00 ~ 600.00	S/min	15.00	●	222
F6-31	Dropping Time of Wobulation	0.00 ~ 600.00	S/min	5.00	●	223

7.1.3 F7 Group: Advanced Parameters of Operation

No.	Function	Range	Unit	Default	Type	S/N
F7-00	Overload Pre-Alarm Control	Ones place: Overload pre-alarm detection 0: Detect all the time 1: Detect at constant speed Tens place: inverter status after pre-alariming 0: Alarm on, run continuously 1: Delayed stop after alarm		00	○	224
F7-01	Overload Pre-Alarm Detection Time	0.00 ~ 60.00	S	5.00	○	225
F7-02	Overload Pre-Alarm Detection Scale	0.00 ~ 600d.00	%	200.00	○	226
F7-03	Overload Pre-Alarm Stop Delay Time	0.00 ~ 600.00	S	5.00	○	227
F7-04	Analog ADT Options	0: VS 0.00 ~ 100.00% 1: IS 0.00 ~ 100.00% 2: VF 0.00 ~ 100.00% 3: IF 0.00 ~ 100.00%		2	○	228
F7-05	Analog ADT1	0.00 ~ 100.00	%	20.00	●	229
F7-06	Analog ADT1 Hysteresis	0.00 ~ 100.00 (Monotonic decreasing is active)	%	5.00	●	230
F7-07	Analog ADT2	0.00 ~ 100.00	%	50.00	●	231
F7-08	Analog ADT2 Hysteresis	0.00 ~ 100.00 (Monotonic decreasing is active)	%	5.00	●	232
F7-09	Analog ADT3	0.00 ~ 100.00	%	80.00	●	233
F7-10	Analog ADT3 Hysteresis	0.00 ~ 100.00 (Monotonic decreasing is active)	%	5.00	●	234
F7-11	Jog M0 Output Lower Limit	0.00 ~ 100.00	%	0.00	●	235
F7-12	Jog M0 Output Upper Limit	0.00 ~ 100.00	%	100.00	●	236
F7-13	Jog M0 Output Gain	0.00 ~ 300.00	%	95.00	●	237

User Manual
EM303B General Purpose Inverter

F7-14	Jog M1 Output Lower Limit	0.00~100.00	%	0.00	●	238
F7-15	Jog M1 Output Upper Limit	0.00~100.00	%	100.00	●	239
F7-16	Jog M1 Output Gain	0.00~300.00	%	95.00	●	240
F7-17 ~ F7-19	Not Used					241 ~ 243
No.	Function	Range	Unit	Default	Type	S/N
F7-20	Automatic PMW	0: Disabled, 1: Enabled		0	●	244
F7-21	Lower Limit Carrier Frequency	1.000~F7-22	kHz	2.000	●	245
F7-22	Upper Limit Carrier Frequency	0~9kW:1.000~16.000 9kW~37kW:1.000~8.000 37kW~110kW:1.000~4.000 110kW~400kW: 1.000~3.000	kHz	6.000	●	246
F7-23	Not Used					247
F7-24	Slip Filter Time	0.01~20.00	S	1.00	●	248
F7-25	Stator Voltage drop Compensation Gain	0.00~200.00	%	100.00	●	249
F7-26	Deadband Compensation Gain	0.00~200.00	%	100.00	●	250
F7-27	Deadband Compensation Mode	0:No Compensation 1:Mode 0 1:Mode 1		1	○	251
F7-28	Minimum base blackout period	0.40~10.00	S	0.50	○	252
F7-29	MIN Effective Output Frequency	0.00~Fmax/0.0~Fmax	Hz	0.00	○	253
F7-30	MIN Acceleration/Deceleration Time	0.05~30.00	S/min	0.05	○	254
F7-31	Zero Frequency Brake Current	100.00~500.00	%	100.00	○	255

7.1.4 F8 Group: Input/Output Bias

No.	Function	Range	Unit	Default	Type	S/N
F8-00	Voltage /Current Input Options	Ones place: VS voltage options 0: 0~10V 1: 2~10V Tens place: VF voltage options 0: 0~10V 1: 2~10V Hundreds place: IS current options 0: 4~20mA 1: 0~20mA Thousands place: IF current options 0: 4~20mA 1: 0~20mA		0000	○	256
F8-01	Voltage/Current Bias Options	Ones place: VS voltage bias options 0: Input / output bias 0		2210	○	257

User Manual
EM303B General Purpose Inverter

		1: Input / output bias 1 2: Input / output bias 2 Tens place:VF voltage bias options 0: Input / output bias 0 1: Input / output bias 1 2: Input / output bias 2 Hundreds place: IS current bias options 0: Input / output bias 0 1: Input / output bias 1 2: Input / output bias 2 Thousands place: IF current bias options 0: Input / output bias 0 1: Input / output bias 1 2: Input / output bias 2				
F8-02	VP Bias Options	0: Input / output bias 0 1: Input / output bias 1 2: Input / output bias 2		2	○	258
F8-03	VP Filter Time	0.00~60.00	S	0.10	●	259
F8-04	VS Filter Time	0.00~60.00	S	0.10	●	260
F8-05	IS Filter Time	0.00~60.00	S	0.10	●	261
F8-06	VF Filter Time	0.00~60.00	S	0.10	●	262
F8-07	IF Filter Time	0.00~60.00	S	0.10	●	263
Input/output Bias 0						
F8-08	Output Bias 0_0	0.00~100.00	%	0.00	●	264
F8-09	Output Bias 0_1	0.00~100.00	%	25.00	●	265
F8-10	Output Bias 0_2	0.00~100.00	%	75.00	●	266
F8-11	Output Bias 0_3	0.00~100.00, 100.00=Fmax	%	100.00	●	267
F8-12	Input Bias 0_0	0.00~ Input Bias 0_1	%	0.00	●	268
F8-13	Input Bias 0_1	Input Bias 0_0~ Input Bias 0_2	%	25.00	●	269
F8-14	Input Bias 0_2	Input Bias 0_1~ Input Bias 0_3	%	75.00	●	270
F8-15	Input Bias 0_3	Input Bias0_2~100.00	%	100.00	●	271
Input/output Bias 1						
F8-16	Output Bias 1_0	0.00~100.00	%	0.00	●	272
F8-17	Output Bias 1_1	0.00~100.00	%	25.00	●	273
F8-18	Output Bias 1_2	0.00~100.00	%	75.00	●	274
F8-19	Output Bias 1_3	0.00~100.00, 100.00=Fmax	%	100.00	●	275
F8-20	Input Bias 1_0	0.00~ Input Bias 1_1	%	0.00	●	276
F8-21	Input Bias 1_1	Input Bias 1_0~ Input Bias 1_2	%	25.00	●	277
F8-22	Input Bias 1_2	Input Bias1_1~ Input Bias1_3	%	75.00	●	278
F8-23	Input Bias 1_3	Input Bias1_2~100.00	%	100.00	●	279
Input/output Bias 2						
F8-24	Output Bias 2_0	0.00~100.00	%	0.00	●	280
F8-25	Output Bias 2_1	0.00~100.00	%	25.00	●	281
F8-26	Output Bias 2_2	0.00~100.00	%	75.00	●	282

F8-27	Output Bias 2_3	0.00~100.00, 100.00=Fmax	%	100.00	●	283
F8-28	Input Bias 2_0	0.00~ Input Bias 2_1	%	0.50	●	284
F8-29	Input Bias 2_1	Input Bias 2_0~ Input Bias 2_2	%	25.00	●	285
F8-30	Input Bias 2_2	Input Bias 2_1~ Input Bias 2_3	%	75.00	●	286
F8-31	Input Bias 2_3	Input Bias 2_2~100.00	%	100.00	●	287

7.1.5 F9 Group: Speed Setting Options

No.	Function	Range	Unit	Default	Type	S/N
F9-00	Not Used					288
F9-01	Parameter Editing Mode	0:Editable through keypad and RS485 1:Editable through keypad		0	○	289
F9-02	Numeric Input Control Mode	Ones place: Numeric reference input control mode 0: Auto-save the change in RAM (Press DATA/ENTER to save) 1: Auto-save the change in EEPROM (Memory function at power failure) Tens place: Not used Hundreds place: Not used Thousands place: Terminal UP/DOWN rate control 0: Automatic rate control 1: Correspond to the setting UP/DOWN rate Ten thousands place: Not Used		1000	○	290
F9-03	Speed Setting Mode	Ones place: Integrated speed input mode 0: Primary speed setting mode 1: Auxiliary speed setting mode 2:Primary speed setting mode + auxiliary speed setting mode Tens place: Speed setting mode under jog control 0: Jog numeric speed setting mode 1: Jog numeric speed setting mode + primary speed setting mode 2: Jog numeric speed setting mode + auxiliary speed setting mode Hundreds place: Relation between auxiliary speed and primary speed 0: Primary speed + auxiliary speed 1: Primary speed - auxiliary speed		000	○	291
F9-04	Special Speed Setting Mode	0: Program Operation 1: Wobulation Mode 2: Stepping Mode 0 3: Stepping Mode 1		0	○	292

User Manual
EM303B General Purpose Inverter

		4: Stepping Mode 2 5: Stepping Mode 3 6: Stepping Mode 4 7: Stepping Mode 5				
F9-05	Auxiliary Speed Setting Mode	0: Auxiliary numeric frequency 1: VP 2: VS 3: IS 4: Not Used 5: $K3*VS+K4*IS$ 6: $K3*VS+K5*VF$ 7: $K4*IS+K6*IF$ 8: $MAX\{K3*VS,K5*VF\}$ 9: $MAX\{K4*IS,K6*IF\}$ 10: $K1*VP+K2*(K3*VS+K4*IS+K5*VF+K6*IF-K8*5V)$	0		○	293
F9-06	Auxiliary Numeric Frequency Setting	0.00~Fmax/0.0~Fmax	Hz	0.00	●	294
F9-07	UP/DOWN Frequency Rate	0.00~100.00/0.0~100.0	Hz/S	1.00	●	295
F9-08	Regular Speed Setting Mode Special Speed Setting Mode Auxiliary Speed Setting Mode Process PID Output	Ones place: Regular speed setting mode options 0: Regular frequency input 1: $VS*$ Regular frequency input 2: $VF*$ Regular frequency input 3: $IS*$ Regular frequency input 4: $IF*$ Regular frequency input Tens place: Special speed setting mode options 0: Special frequency input 1: $VS*$ Special frequency input 2: $VF*$ Special frequency input 3: $IS*$ Special frequency input 4: $IF*$ Special frequency input Hundreds place: Auxiliary speed setting mode options 0: Auxiliary frequency input 1: $VS*$ Auxiliary frequency input 2: $VF*$ Auxiliary frequency input 3: $IS*$ Auxiliary frequency input 4: $IF*$ Auxiliary frequency input Thousands place: Process PID Output mode options 0: PID output 1: $VS*$ PID output 2: $VF*$ PID output	0000		○	296

User Manual
EM303B General Purpose Inverter

		3: IS* PID output 4: IF* PID output 5: Auxiliary frequency* PID output				
F9-09	Frequency of Zero Speed Detection	0.00~50.00/0.0~50.0	Hz	0.00	○	297

No.	Function	Range	Unit	Default	Type	S/N
F9-10	Zero Speed Detection Output Delay	0.00~600.00	S	1.00	○	298
F9-11	Frequency Reach Range FAR	0.00~50.00/0.0~50.0	Hz	2.50	○	299
F9-12	FDT1 Increasing Threshold	0.00~Fmax /0.0~Fmax	Hz	30.00	○	300
F9-13	FDT1 Decreasing Threshold	0.00~Fmax /0.0~Fmax	Hz	30.00	○	301
F9-14	FDT2 Increasing Threshold	0.00~Fmax /0.0~Fmax	Hz	30.00	○	302
F9-15	FDT2 Decreasing Threshold	0.00~Fmax /0.0~Fmax	Hz	30.00	○	303
F9-16	Cut-off Frequency of Oscillation Suppression	20~400	%	90	○	304
F9-17	Non-Stop Control Options at Instantaneous Power Failure	0: Disabled 1: Enabled		0	○	305
F9-18	Speed Search Current	0.30~1.50		0.60	○	306
F9-19	Speed Search Coefficient	1.00~1.30		1.05	○	307
F9-20	Control Voltage of Non-Stop at Instantaneous Power Failure	0~800	V	537	●	308
F9-21	Proportion Gain of Non-Stop at Instantaneous Power Failure	0.00~300.00		0.50	●	309
F9-22	Integral Time of Non-Stop at Instantaneous Power Failure	0.00~600.00	S	1.50	●	310
F9-23	Base Time of Non-Stop at Instantaneous Power Failure	0.00~600.00	S	2.00	●	311
F9-24	Start Delay Time After Power-on	0.00~10.00 (The time for inverter to wait for the initial operation after power-on)	S	1.00	●	312
F9-25	Terminal Operation Command Control	0: Terminal shall be off first, and then on. 1: Terminal shall not be off, inverter will run directly.		1	○	313
F9-26	Voltage Resume Time of Speed Search	0.00~5.00	S	0.30	●	314
F9-27	Oscillation Suppression	0~20000		300	●	315

	Gain					
F9-28	Speed Search Mode of Software	0: Maximum frequency 1: Stop frequency 2: Setting frequency		0	○	316
F9-29	Not Used					317

No.	Function	Range	Unit	Default	Type	S/N
F9-30	Undervoltage Detection Scale	0.00~100.00 (Udc_e)	%	65.18	○	318
F9-31	Undervoltage Detection Time	0.00~30.00	S	0.50	○	319

7.1.6 FA Group: Advanced Parameters of Vector Control

No.	Function	Range	Unit	Default	Type	S/N
FA-00 ~ FA-05	Not Used					320 ~ 325
FA-06	Regular Torque Options	0: Regular torque input 1: VS* Regular torque input 2: VF* Regular torque input 3: IS* Regular torque input 4: IF* Regular torque input		0	○	326
FA-07	Preset Current Limit 1	0.00~180.00	%	150.00	○	327
FA-08	Preset Current Limit 2	0.00~180.00	%	150.00	○	328
FA-09	Preset Current Limit 3	0.00~180.00	%	150.00	○	329
FA-10	Preset Current Limit 4	0.00~180.00	%	150.00	○	330
FA-11	Preset Current Limit 5	0.00~180.00	%	150.00	○	331
FA-12	Preset Current Limit 6	0.00~180.00	%	150.00	○	332
FA-13	Preset Current Limit 7	0.00~180.00	%	150.00	○	334
FA-14	Motor 2 Rated Power	0.40~480.00	kW	XXXX	○	335
FA-15	Motor 2 Rated Voltage	60~660	V	XXX	○	336
FA-16	Motor 2 Rated Current	0.1~1500.0	A	XXXX	○	337
FA-17	Motor 2 Rated Frequency	20.00~600.00/20.0~6000.0	Hz	XXXX	○	338
FA-18	Motor 2 Rated Speed	1~60000	rpm	XXXX	○	339
FA-19	Motor 2 Wiring Mode	0: Y, 1: Δ		X	○	340
FA-20	Motor 2 Rated Power Factor	0.50~0.99		X	○	341
FA-21	Motor 2 Idling Excitation Current I0	0.1~1500.0	A	XXXX	○	342
FA-22	Motor 2 Rated Torque Current	0.1~1500.0	A	XXXX	×	343
FA-23	Motor 2 Stator Resistance R1	0.01~60.000	Ω	XXXX	○	344

User Manual
EM303B General Purpose Inverter

FA-24	Motor 2 Rotator Resistance R2	0.01~60.000	Ω	XXXX	○	345
FA-25	Motor 2 Stator& Rotor Leakage Inductance Ls	0.1~3000.0	mH	XXXX	○	346
FA-26	Motor 2 Stator& Rotor Mutual Inductance Lm	0.1~3000.0	mH	XXXX	○	347
No.	Function	Range	Unit	Default	Type	S/N
FA-27	Motor 2 Efficiency	30.0~99.0	%	XXXX	○	348
FA-28 ~ FA-31	Not Used					349 ~ 351

7.1.7 Fb Group: Not Used

No.	Function	Range	Unit	Default	Type	S/N
Fb-00 ~ Fb-31	Not Used					352 ~ 383

7.1.8 FC Group: Parameters of Operation Control

No.	Function	Range	Unit	Default	Type	S/N
FC-00	Acceleration/ DecelerationMode	0: Linear mode 1: S curve mode		0	○	384
FC-01	Proportion of Acceleration S Curve	0.0~50.0	%	30.0	○	385
FC-02	Proportion of Deceleration S Curve	0.0~50.0	%	30.0	○	386
FC-03	Fan Control	0: Run at power-on 1: Run at start-up		1	○	387
FC-04	Fan Delay Time	0.00~600.00	S	30.00	●	388
FC-05	Not Used					389
FC-06	Resume previous working status at power-on	0: Not Resume 1: Resume		0	○	390
FC-07	Current Stall Control	0: Disabled 1: Not Used 2: Enabled		2	○	391
FC-08	Overcurrent Stall Current	50.00~180.00	%	150.00	○	392
FC-09	Current Limit Coefficient of Weak Flux	0.20~1.00		0.70		393
FC-10	Energy Saving Operation Options	0: Energy saving operation disabled 1: Energy saving operation enabled		0	○	394
FC-11	Energy Saving Running Initial Frequency	10.00~600.00/10.0~600.0	Hz	20.00	○	395
FC-12	Energy Current Detecting	20.00~80.00	%	40.00	○	396

User Manual
EM303B General Purpose Inverter

	Range					
FC-13	Energy Saving Delay Start Time	0.01~60.00	S	0.50	○	397
FC-14	Energy Saving Permitted Range	60.00~100.00	%	80.00	○	398
FC-15	Output Voltage	0.00~100.00	%	100.00	●	399
FC-16	Brake Duty Ratio	5.00~100.00	%	80.00	○	400
No.	Function	Range	Unit	Default	Type	S/N
FC-17	Over-modulation Coefficient	1.00~1.10		1.05	●	401
FC-18	Voltage Control	Ones place: AVR control 0: Disabled 1: Enabled 2: Auto-AVR Tens place: AVR limit control 0: Limit disabled 1: Limit enabled Hundreds place: Not used		001	○	402
FC-19	Overvoltage Protection Control	Ones place: Not Used Tens Place: Dynamic brake options 0: Braking resistor disabled 1: Braking resistor is enabled in operation 2: Braking resistor is enabled at power-on Hundreds place: Not Used Thousands place: Voltage stall protection mode 0.Void 1.Under voltage stall effective 2.Over voltage stall effective 3.Both under voltage stall and over voltage stall effective		2000	○	403
FC-20	Voltage at Overvoltage Stall	120.00~140.00	%	130.00	○	404
FC-21	Overcurrent Stall Proportion Gain IKp	0.00~100.00		0.10	○	405
FC-22	Overvoltage Stall Proportion Gain VKp	0.00~100.00		3.00	○	406
FC-23	Overvoltage Integral Time VTi	0.000~10.000, 0.000: No integration	S	0.300	○	407
FC-24	Fault Retry Control	Ones place: Fault retry times 0: Fault retry prohibited 1~3: Fault retry for 1, 2, and 3 times 4: Unlimited fault retry Tens place: In fault retry, fault output terminals will be 0: Off 1: On		00	○	408
FC-25	Fault Retry Timelag	0.01~30.00	S	0.50	○	409
FC-26	No Fault Timelag	0.01~30.00	S	10.00	○	410

FC-27	Fault Retry Options	*	OL	ILP	SLU	SOV	SDC	HOU	HOC	11111111	○	411	
		1	1	1	1	1	1	1	1				1
		0: Fault retry permitted 1: Fault retry prohibited											
FC-28	Disabled Trips 1	OL	ILP	SLU	SOV	SDC	*	*	*	00000000	○	412	
		0	0	0	0	0	0	0	0				0
		0: Enabled , 1: Disabled , *: Not Used											

No.	Function	Range								Unit	Default	Type	S/N
FC-29	Disabled Trips 2	EE _d	ES _t	*	*	*	EHL	OLP	OH	00000010	○	413	
		0	0	0	0	0	0	1	0				
		0: Enabled , 1: Disabled, *: Not Used											
FC-30	Disabled Trips 3	*	OL ₁	SOFL	StE	SrE	SFE	SLP	EEU	00000000	○	414	
		0	0	0	0	0	0	0	0				
		0: Enabled, 1: Disabled, *: Not Used											
FC-31	Integral Time of Overcurrent Stall	0.00~300.00								mS	20.00	○	380

7.1.9 Fd Group: Auxiliary Parameters

No.	Function	Range	Unit	Default	Type	S/N
Fd-00	Not Used					461
Fd-01	Voltage 1	0.00~100.00	%	1.00	●	417
Fd-02	Voltage 2	0.00~100.00	%	4.00	●	418
Fd-03	Voltage 3	0.00~100.00	%	10.00	●	419
Fd-04	Voltage 4	0.00~100.00 Ue=100.0%	%	16.00	●	420
Fd-05	Frequency 1	0.00~Frequency 2 /0.0~Frequency 2 Fbase=100.0%	%	1.00	●	421
Fd-06	Frequency 2	Frequency 1~Frequency 3	%	4.00	●	422
Fd-07	Frequency 3	Frequency 2~Frequency 4	%	10.00	●	423
Fd-08	Frequency 4	Frequency 3~100.00	%	16.00	●	424
Fd-09	Torque Boost Voltage	0.00~10.00	%	0.00	●	425
Fd-10	Cut-off Frequency of Torque Boost	0.00~100.00	%	20.00	●	426
Fd-11	Output Voltage Setting Mode in VF Separation Mode	0:Disabled		0	○	427
		1:Numeric Setting(FC-15)				
		2: VP Setting				
		3: VS Setting				
		4: VF Setting				
		5: IS Setting				
6: IF Setting						
Fd-12	Voltage Change Time	0.00~60.00	S	5.00	●	428
Fd-13 ~	Not Used					429 ~

Fd-19						435
Fd-20	CPUB Software Version	X.XX		X.XX	X	436
Fd-21	Inverter Rated Power	0.40~480.00	kW	XXXX	X	437
Fd-22	Inverter Rated Voltage	60~660	V	XXX	X	438
Fd-23	Inverter Rated Current	0.1~1500.0	A	XXXX	X	439
Fd-24	Inverter Running Time	User monitoring	HOUR	XXXX	X	440
Fd-25	Inverter Running Time	User monitoring	min	XXXX	X	441

No.	Function	Range	Unit	Default	Type	S/N
Fd-26	Running Time Control	0:Disabled 1:Enabled		0	-	442
Fd-27	Set Running Time	0~65535	HOUR	0	-	443
Fd-28	Distributor Password					444
Fd-29	Manufacturer Password					445
Fd-30	Keypad Software Version	X.XX		X.XX	X	446
Fd-31	CPUA Software Version	X.XX		X.XX	X	447

7.1.10 FE Group: User Defined Terminal Function Parameters

No.	Function	Range	Unit	Default	Type	S/N
FE-00	Numeric Input Filter Times	0~100; 1=0.50mS		10	○	448
FE-01	Terminal Input Positive/Negative Logic	X7 X6 X5 X4 X3 X2 X1 0 0 0 0 0 0 0		0000000 0	○	449
		0: Positive Logic. On at 0V/Off at 24V 1: Negative Logic. Off at 0V/ On at 24V				
FE-02	X1 Input Delay Time	0.00~300.00	S	0.00	○	450
FE-03	X2 Input Delay Time	0.00~300.00	S	0.00	○	451
FE-04	Analog Input Signal Options	Ones place: VS input signal options 0: Analog signal input 1: Numeric signal input Tens place: IS input signal options 0: Analog signal input 1: Numeric signal input Hundreds place: VF input signal options 0: Analog signal input 1: Numeric signal input Thousands place: IF input signal options 0: Analog signal input 1: Numeric signal input		0000	○	452
FE-05	Analog Terminal Input Logic	Ones place: Input terminal VS 0: VS is on at high level input 1: VS is on at low level input Tens place: Input terminal IS 0: IS is on at high level input 1: IS is on at low level input Hundreds place: Input terminal VF		0000	○	453

User Manual
EM303B General Purpose Inverter

		0: VF is on at high level input 1: VF is on at low level input Thousands place: Input terminal IF 0: IF is on at high level input 1: IF is on at low level input				
FE-06	Output Signal Type	Ones place: Y1 output type 0: Level signal 1: Pulse signal Tens place: Y2 output type 0: Level signal 1: Pulse signal Hundreds place: R1 output type 0: Level signal 1: Pulse signal		000	○	454
FE-07	Terminal Output Logic Options	Ones place: Y1 output logic options 0: Positive logic 1: Negative logic Tens place: Y2 output logic options 0: Positive logic 1: Negative logic Hundreds place: R1 output logic options 0: Positive logic 1: Negative logic		000	○	455
FE-08	Virtual Terminal Options	Ones place: Terminals Y1/Y2/R1 0: Actual output terminal 1: Virtual output terminal Tens place: Multi-function Input Terminal Xi 0: Actual output terminal 1: Virtual output terminal Hundreds place: Numeric terminal VS/IS/VF/IF 0: Actual output terminal 1: Virtual output terminal		000	○	456
FE-09	Terminal Y1 Delay Time	0.0~600.0	S	0.0	○	457
FE-10	Terminal Y1 Pulse Width	0.0~600.0	S	5.0	○	458
FE-11	Terminal Y2 Delay Time	0.0~600.0	S	0.0	○	459
FE-12	Terminal Y2 Pulse Width	0.0~600.0	S	5.0	○	460
FE-13	Terminal R1 Delay Time	0.0~600.0	S	0.0	○	461
FE-14	Terminal R1 Pulse Width	0.0~600.0	S	5.0	○	462
FE-15 ~ FE-19	Not Used					463 ~ 467
FE-20	SC and EFC Faults Display	0: SC Drive failure 1: EFC Environment failure		0	X	468
FE-21	SLU and SDFt Faults Display	0: SLU Stable undervoltage fault		0	X	469

User Manual
EM303B General Purpose Inverter

		1: <i>SDFE</i> Soft-start fault				
FE-22	<i>SC1</i> <i>rSP1</i> <i>rPI</i> <i>d</i> Faults Display	0: <i>SC1</i> Fault 1: <i>SP1</i> Fault 2: <i>PI</i> <i>d</i> Feedback loss fault		0	X	470
FE-23 ~ FE-31	Not Used					471 ~ 479

8 Parameter Description

Section 1 General Parameters

8.1 F0 Group: General Parameters

No.	Function	Range	Unit	Default	Type
F0-00 (L)	Speed Reference Input Monitoring	Frequency: 0.00~Fmax/0.0~Fmax Speed: 0~F*Customer defined	Hz Rpm	0.00/0 0.0/0	X
F0-01 (H)	Torque Reference Input Monitoring	scaling Torque input: 0.00~Limited torque	%	0.00	

F0-00 and F0-01 are optional and for reference only. Their parameters are the setting value of present drive mode. Symbol (-) shall be displayed if the value is negative. When the reference input control mode is different, the data reflected by F0-00/F0-01 is also different.

Speed Reference Input Monitoring

The unit of F0-00/F0-01 is Hz or rpm which indicates that the present control object is the motor speed, its value is the present setting objective value of speed. When objective value is reverse input, then symbol (-) shall be displayed.

Torque Reference Input Monitoring

The unit of F0-00/F0-01 is % which indicates that the present control object is the motor torque. The value is the percentage of present objective torque current to motor rated torque current. If the objective value is negative torque, then symbol (-) shall be displayed. The setting mode of torque reference input is active only in SVC1.

No.	Function	Range	Unit	Default	Type
F0-02	Drive Control Mode	0:V/F open loop control 1:Not used 2: SVC0 3:SVC1		2	○

F0-02=0 V/F Open Loop Control:Applicable to the occasions when one inverter drives multi-motor, and speed regulation is with low requirements for rapidity and accuracy.

▲F0-02=2 SVC0: Vector control mode 0 (without speed feedback). It only estimates real-time speed, but no feedback control. The whole process of output current is under real-time close-loop control. When motor 0.5 Hz output reaches 150% rated torque, the inverter will automatically search the load variables and limit the output current to make it not exceed the permitted maximum current. Even if load varies suddenly or there is a quick acceleration or deceleration, overcurrent would not occur, so that a general purpose inverter can achieve high performance and reliability.

Remarks:

This mode is only applicable to speed control mode and not to torque control mode.

▲F0-02=3 SVC1: Vector control mode 1 (without speed feedback). It not only estimates speed in real-time, but also controls feedback. Speed and current are under real-time close-loop control all the time. The speed control and torque control can be achieved at the

same time. A regular AC induction motor can be turned into an AC variable speed motor or AC torque motor in this drive mode. It is a genuine sensorless vector control.

Remarks: This mode is applicable to torque / speed control.

	<p>1. Before running in vector control mode, inverter needs to autotune motor parameters for obtaining the correct motor parameters.</p> <p>2. In vector control mode, the inverter only applies to one motor. Motor and inverter shall be the same in terms of capacity. On special occasions, the inverter capacity shall be up-rated one grade. Otherwise, it may lower control performance or the system cannot function normally.</p> <p>3. The sections with ▲ mark are switchable control modes. When running in this mode, V/F open loop control status can be switched to meet different drive needs through multi-function input terminals X1~X7. See 7.3 for programming mode of multi-function input terminals. For example, set F2-02=20, and when terminal X3=ON, the drive mode is switched to V/F mode, and when X3=OFF, it returns to the previous drive mode.</p>
--	---

No.	Function	Range	Unit	Default	Type
F0-03	Reference Input Control Mode	0:Speed input 1: Torque input (F0-02=3)		0	○







F0-03=0 Input control mode is speed input, the input is frequency.

▲**F0-03=1**Input control mode is torque input. The input is percentage of motor rated torque current. It is active only when the control mode is SVC1, i.e. F0-02=3. In SVC1 mode, squirrel cage induction motor can achieve torque control to replace the AC induction torque motor directly.

	<p>The section with ▲ mark is switchable reference input control mode. When running in this mode, terminal can be switched to the status of F0-03=0. When setting one programmable terminal (in F2) =24, the reference input control mode is switched to speed input mode when selecting this terminal. It returns previous input mode when the terminal is off. For example, set F2-02=24, and when terminal X3 is on, the reference input control mode is switched to speed input mode, it will return previous input mode when terminal X3 is off.</p>
--	---

No.	Function	Range	Unit	Default	Type
F0-04	Start/Stop Control Options	0:Keypad 1: Terminal 2: RS485		0	○
F0-05	Terminal Start/Stop Control Options	0: RUN-Run, F/R-Forward/Reverse 1: RUN-Forward, F/R- Reverse 2: RUN-NO forward, Xi-NC stop, F/R-NO reverse 3: RUN-NO run, Xi-NC stop, F/R- Forward/Reverse		0	○

F0-04=0 Keypad Control Mode

Control start/stop of inverter through , ,  buttons on the keypad. When there is no fault, press  to enter jog status, and press  to enter running status. When the green LED indicator on the  button is on, the inverter is in running status, but when it flashes, the inverter is in ramp-to-stop status. No matter the reference input control mode is speed or torque, when pressing , the inverter always runs in jog speed input control mode.

F0-04=1 Terminal Control Mode

Start/Stop of inverter is controlled by Start/Stop control terminals defined by F2-00~F2-06. When the settings of multi-function terminals are defaults, the terminal control wiring is as shown in Figure 7-1.

The specific setting of terminal control is determined by F0-05.

F0-04=2 RS485 Control Mode

Start/Stop of inverter is under PC or PLC control through RS485 communication interface.

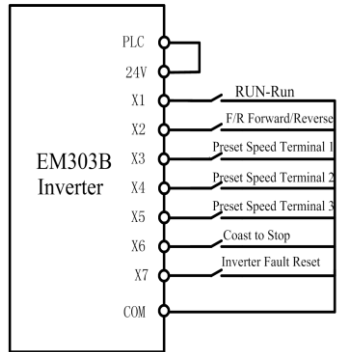



Figure 7-1
Wiring of Terminal Control

 1. No matter in what drive control mode, when pressing , the inverter always runs in jog speed input control mode.

Terminal control modes can be classified as 2-wire sequence and 3-wire sequence.

2-wire sequence:

F0-05=0 Start/stop of inverter is under control of ON/OFF of terminal RUN, and forward/reverse of inverter is under control of OFF/ON of terminal F/R. If F0-24=1 and reverse is prohibited, terminal F/R is off. When stop mode is selected as ramp-to-stop, the sequence diagram is as shown in Figure 7-2 (b).

F0-05=1 Forward/stop of inverter is under control of ON/OFF of terminal RUN, and reverse/stop is under control of ON/OFF of terminal F/R. If terminals RUN and F/R are ON simultaneously, the inverter remains previous status. When reverse is prohibited, terminal F/R is off. When stop mode is selected as ramp-to-stop, the sequence diagram is as shown in Figure 7-2 (d).

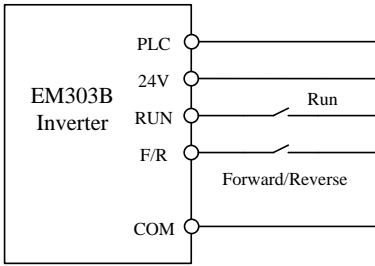

(a) F0-05=0 2-wire sequence

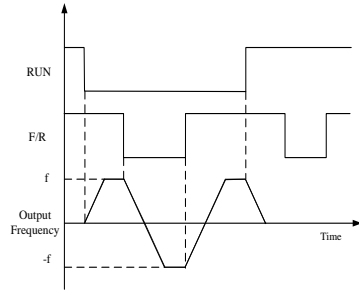

(b) F0-20=0, F0-05=0

Forward/Reverse running sequence

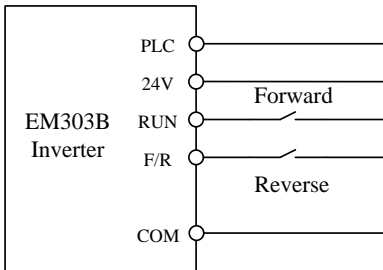

(c) F0-05=1 2-wire sequence

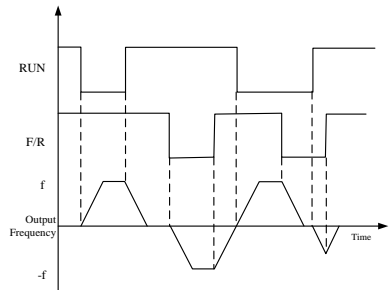

(d) F0-20=0, F0-05=1

Forward/Reverse running sequence

Figure 7-2 2-Wire Sequence



When F0-05= 0 or 1, even if terminal RUN is ON, inverter can be stopped by pressing , stop command of external terminal, or monocyple time of PLC is up. Meanwhile, inverter reenters running status only when terminal RUN is ON again after OFF once.

3-wire sequence:

F0-05=2 RUN is NO forward running button, F/R is NO reverse running button, Xi is NC stop button, all of them will be on at pulse edge. In running status, the inverter stops if pressing Xi button. When stop mode is selected as ramp-to-stop (F0-20=0), see Figure 7-3 (b) for the sequence diagram. Xi is the terminal among X1~X7 defined as 3-Wire Sequence Run/Stop Control by F2-00~F2-06.

F0-05=3 F/R is forward/reverse switching button (Forward when F/R is off, and reverse when F/R is on.) RUN is NO running button, and Xi is NC stop button, all of them will be on at pulse edge (F/R is on at level). When stop mode is selected as ramp-to-stop (F0-20=0), the sequence diagram is as shown in Figure 7-3(d).

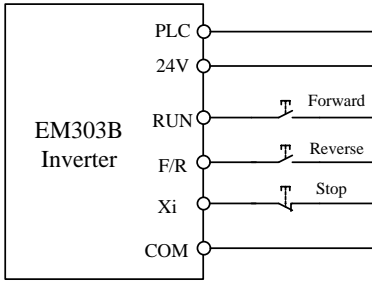

(a) F0-05=2 3-wire sequence

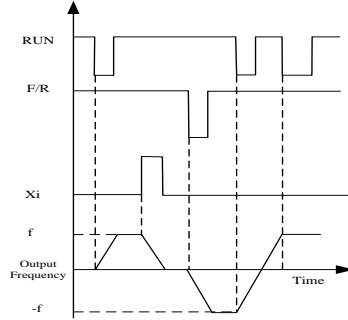

(b) F0-20=0, F0-05=2
Forward/Reverse running sequence

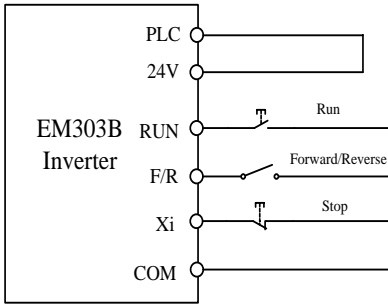

(c) F0-05=3 3-wire sequence

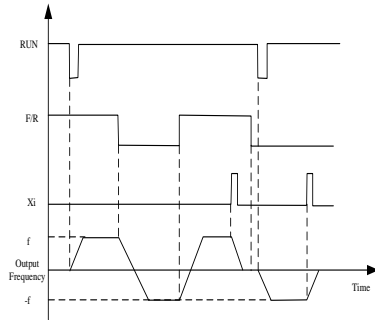

(d) F0-20=0, F0-05=3
Forward/Reverse running sequence

Figure 7-3 3-Wire Sequence



Please use the buttons and switches correctly by following the mode illustrated in the above diagrams of EM303B 3-wire sequences, otherwise, malfunctions may occur.

No.	Function	Range	Unit	Default	Type
F0-06	Regular Speed Setting Mode	0: Primary Numeric Frequency 1: VP 2: VS 3: IS 4: Not Used 5: $K3*VS+K4*IS$ 6: $K3*VS+K5*VF$ 7: $K4*IS+K6*IF$ 8: $MAX\{K3*VS,K5*VF\}$ 9: $MAX\{K4*IS,K6*IF\}$ 10: $K1*VP+K2*(K3*VS+K4*IS+K5*VF+K6*IF-K8*5V)$		1	○

F0-06 Forselecting the source of regular speed setting signal.

F0-06=0 Primary numeric frequency setting mode is defined by the value of F0-07.

F0-06=1 Setting frequency is set by VP keypad potentiometer.

F0-06=2 Setting frequency is set by the voltage of analog terminal VS.

F0-06=3 Setting frequency is set by the current of analog terminal IS.

F0-06=4 Not used

F0-06=5 Setting frequency is set by $K3*VS+K4*IS$ (Input VS and IS signals)

F0-06=6 Setting frequency is set by $K3*VS+K5*VF$ (Input VS and VF voltage signals)

F0-06=7 Setting frequency is set by $K4*IS+K6*IF$ (Input IS and IF current signals)

F0-06=8 Setting frequency is set by the greater value between $K3*VS$ and $K5*VF$ (Inputs of terminals VS and VF)

F0-06=9 Setting frequency is set by the greater value between $K4*IS$ and $K6*IF$ (Inputs of terminals IS and IF)

F0-06=10 Setting frequency is set by all input signals:

$$K1*VP+K2*(K3*VS+K4*IS+K5*VF+K6*IF-K8*5V)$$

- ★ The combination of analog voltage signal and analog current signal can be considered as that the current signal linearly switched to voltage signal of 0-10V first, and then calculate.

	<ol style="list-style-type: none"> 1. The default of analog voltage inputs VS and VF: 0~10V. 2. The default of analog current input: 4~20mA. 3. K1~K8 are analog signal gains which can be set by F1-22~F1-29.
--	---

No.	Function	Range	Unit	Default	Type
F0-07	Primary Numeric Frequency Setting	0.00~Fmax	Hz	0.00	●

F0-07 Thesetting value of primary numeric frequency, and the range: 0.00~Fmax.

- ★ Press or to edit the value of F0-07 in running preparation and running status.

No.	Function	Range	Unit	Default	Type
F0-09	Acceleration Time 1	0.00~600.00	S/min	15.00	●
F0-10	Deceleration Time 1	0.00~600.00	S/min	15.00	●

Acceleration time is the time taken for the output frequency to rise from 0Hz up to maximum frequency Fmax set by F0-16. Deceleration time is the time taken for the output frequency to drop from Fmax down to 0Hz, which are not relevant to forward and reverse.

As shown in Figure 7-4.

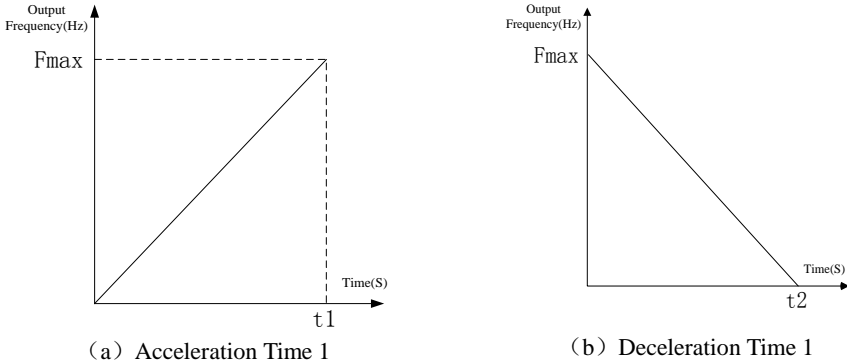



Figure 7-4 Acceleration/Deceleration Time

No.	Function	Range	Unit	Default	Type
F0-11	Jog Numeric Frequency	0.00~Fmax	Hz	5.00	●
F0-12	Jog Acceleration Time	0.00~600.00	S/min	15.00	●
F0-13	Jog Deceleration Time	0.00~600.00	S/min	15.00	●

In Jog running mode, inverter runs at the frequency set by F0-11, the acceleration/deceleration time taken for running to Fmax is set by F0-12/F0-13.

★ Jog acceleration time is the time taken for the output frequency to rise from 0Hz up to maximum frequency Fmax. Deceleration time is the time taken for the output frequency to drop from Fmax down to 0Hz.

★ In jog running mode, keep pressing  or terminal JOG is on. Otherwise, it will be considered as the jog command cancelled.

 Please note that the unit of acceleration /deceleration time is second or minute defined by F3-21.

No.	Function	Range	Unit	Default	Type
F0-14	Carrier Frequency	0kW~9kW: 1.000~16.000 9kW~37kW: 1.000~8.000 37kW~110kW: 1.000~4.000 110kW~400kW: 1.000~3.000	kHz	2.000	●

Increasing carrier frequency could reduce motor noise, but it will result in inverter heating up. When carrier frequency is higher than the default, the rated power of inverter should decrease 5% as each increment of 1 kHz carrier frequency.

Correlation between motor rated power and carrier frequency is suggested as following:

Motor Rated Power P_e	$\leq 15kW$	$\leq 30kW$	$\leq 75kW$	$\leq 132kW$	$> 132kW$
Carrier Frequency F_c	$\leq 10.0kHz$	$\leq 8.0kHz$	$\leq 6.0kHz$	$\leq 4.0kHz$	$\leq 2.5kHz$

The setting range of carrier frequency is limited by power rating:

0kW~9kW: carrier frequency range 1.000~16.000 kHz
 11kW~37kW: carrier frequency range 1.000~8.000 kHz
 45kW~110kW: carrier frequency range 1.000~4.000 kHz
 132kW~400kW: carrier frequency range 1.000~3.000 kHz

No.	Function	Range	Unit	Default	Type
F0-15	Torque Boost			35	●

F0-15=0 Automatic torque boost
F0-15=1~10 Fixed torque boost curve
F0-15=11~20 Oil pump motor boost curve
F0-15=21~30 Synchronous motor boost curve
F0-15=31~34 Blower/water pump boost curve
F0-15=35 Customer defined V/F curve scaling (Defined via Fd-01~Fd-08)

No.	Function	Range	Unit	Default	Type
F0-16	Maximum Frequency	Fmax: 20.00~600.00	Hz	50.00	○
F0-17	Upper Limit Frequency	Fup: Fdown~Fmax	Hz	50.00	○
F0-18	Lower Limit Frequency	Fdown: 0.00~Fup	Hz	0.00	○

F0-16 Fmax indicates the maximum setting frequency permitted by inverter. Range of Fmax: 20.00~600.00.

F0-17 Fup indicates the maximum frequency permitted to run after inverter start-up. Range of Fup: Fdown~Fmax.

F0-18 Fdown indicates the minimum frequency permitted to run after inverter start-up. Range of Fdown: 0.00Hz~Fup.



1. Upper limit frequency and lower limit frequency should be set prudently as per the actual parameters listed on the nameplate of controlled motor and operational status. Do not make the motor run for a long time in the lower frequency status. Otherwise, the service lifespan of motor will be reduced due to overheating.

2. Correlation of maximum frequency, upper limit frequency, and lower limit frequency: $0.00\text{Hz} \leq F_{\text{down}} \leq F_{\text{up}} \leq F_{\text{max}} \leq 600.00\text{Hz}$

No.	Function	Range	Unit	Default	Type
F0-19	Start Mode Options	0: Normal start 1: Speed search start		0	○

F0-19=0 Start as per setting mode: Zero speed start, or DC brake first, and then zero speed start.

F0-19=1 Speed search start: Before inverter starts, the motor may be rotating. Detecting motor speed and direction when inverter starts running, the speed and running direction of motor can be directly searched base on the detection result. Smooth start can be applied to the motor which is rotating. The process of speed search is as shown in Figure 7-5.

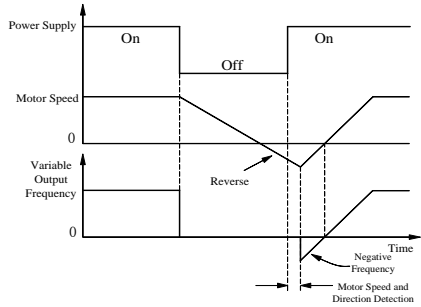

Figure7-5 Speed Search Start

- i**
1. Load inertia shall be taken into consideration when increasing the setting value of acceleration/deceleration time in speed search start mode.
 2. Speed search start mode is applicable to the occasion when one inverter drives one motor, especially practical for industrial dryer. Due to the grid power outage or accidental fault of inverter, the industrial dryer will rotate freely for a long time. Speed search start can ensure that the industrial dryer returns normal work as short as possible.

Before inverter starts, the motor may run at low speed or in opposite rotation status. If inverter starts immediately at mean time, overcurrent may occur. In order to avoid such fault, before inverter starts, please start DC brake to stop motor, and then the inverter runs to setting frequency as per setting direction. See F3-22, F3-23 for the setting method of starting DC brake.

No.	Function	Range	Unit	Default	Type
F0-20	Stop Mode Options	0: Ramp to stop 1: Coast to stop		0	○

Stop Mode Setting:

Ramp to Stop

F0-20=0 Motor is ramp-to-stop in setting deceleration time.

【Default is F0-10 Deceleration Time 1】



Coast to Stop

F0-20=1 While the stop command is input, inverter stops output immediately, and the motor coasts to stop. The stop time is up to load inertia.

If there is a coast-to-stop terminal and when it is on, the inverter enters coast-to-stop status immediately, and when it is off, the inverter will not restart only if giving the run command again.

No.	Function	Range	Unit	Default	Type
F0-21	 Function Setting	0: Jog running 1: Positive/Negative input switching 2: Disabled		0	○

F0-21=0  on keypad is for jog running function.

F0-21=1  on keypad is for positive/negative input switching function, i.e. when the settings are positive speed, positive PID, and positive torque,  is for switching to negative speed, negative PID, and negative torque.

F0-21=2  on keypad is disabled.

No.	Function	Range	Unit	Default	Type
F0-22	Speed Monitoring Options	0: Frequency Hz 1: Speed rpm		0	●
F0-23	Customer Defined Scaling	0.01~600.00		30.00	●

F0-22 is for setting speed display. If F0-22=0, the reference input value displayed on keypad is the target output frequency of inverter. If F0-22=1, the reference input value is the target output speed of inverter.

F0-23 Customer defined scaling. Mechanical speed = Mechanical speed coefficient (Customer defined scaling) * Output frequency. When the unit of setting speed is rpm, adjusting the parameter of F0-23 will make the displayed value of motor speed match the actual value.

No.	Function	Range	Unit	Default	Type
F0-08	Motor Running Direction	0: Forward 1: Reverse		0	●
F0-24	Forward/Reverse Control Mode	0: Reverse Permitted 1: Reverse Prohibited		0	○
F0-25	F/R Deadband Time	0.00~600.00	S	0.00	○

F0-08 Motor running direction: F0-08=0 is forward. When F0-24=0 reverse permitted, the running direction will be switched as reverse when F0-08=1.

Permission of Motor Forward/Reverse

F0-24=0 Reverse permitted

Motor's running direction is set by F0-08, or controlled by terminal F/R.

F0-24=1 Reverse prohibited

Motor can only run in one direction. F0-08 parameters are disabled, and terminal F/R is off.

Deadband of Switching the Forward/ Reverse of Motor

If F0-25=0.00, there is no deadband of forward/reverse.

If F0-25≠0, when forward/reverse switches, the inverter runs at 0Hz in the time set by F0-25 as the motor speed drops to 0Hz, and then runs to setting frequency in opposite direction. As shown in Figure7-6.

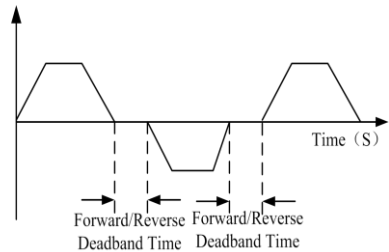

Figure 7-6 Forward/Reverse Deadband



1. When reverse is permitted, inverter will judge present running direction based on the setting of F0-08 and the status of terminal F/R. If F0-08=1 and terminal F/R is on, inverter runs forward.
2. If the setting forward direction of inverter is not identical with the expected running direction of motor, switch any two of output cables (U, V, and W) of inverter or set F0-08=1.

No.	Function	Range	Unit	Default	Type
F0-26	Primary Speed Setting Mode	0: Regular speed setting mode 1: Special speed setting mode 2: Process PID input mode		0	○

F0-26=0 Primary speed setting mode is the regular speed setting mode. Primary numeric speed setting mode or analog signal setting mode can be set by selecting parameter of F0-06.

F0-26=1 Primary speed setting mode is the special speed setting mode. Special speed setting mode can be selected as program running or stepping speed setting mode by advanced running mode.

F0-26=2 Primary speed setting mode is process PID input mode. Numeric PID setting mode or analog signal setting mode can be selected via F4-00.

No.	Function	Range	Unit	Default	Type
F0-27	Menu Mode Options	0: Basic menu mode 1: Advanced menu mode		0	○

F0-27=0 Keypad only displays the basic setting parameters of F0~F5. (6-group parameters could meet the needs of most of applications.)

F0-27=1 Keypad displays 17-group parameters of F0~FF for users to set parameters.

No.	Function	Range	Unit	Default	Type
F0-28	Default Control	0: Disabled 1: Defaults Reset		0	○

No.	Function	Range	Unit	Default	Type
F0-29	Parameter Setting Control	0: Parameter setting permitted 1: Parameter lock 0 2: Parameter lock 1		0	○

Reset Default

F0-28=1 Reset Default: Except motor parameters in Group F1 Group and FA Group, and inverter parameters in Fd Group, the rest of parameters will reset to default. After reset completed, F0-28=0.

Parameter Lock

F0-29=0 All parameters are allowed to be edited.

F0-29=1Parameter lock 0

Lock parameters except numeric settings. The numeric settings are primary numeric frequency setting F0-07, auxiliary numeric frequency setting F9-06, jog running frequency

F0-11, preset speed 1~15 (F3-00~F3-14), PID numeric setting F4-01, and numeric torque current F5-12.

F0-29=2Parameter locked 1

Lock parameters except F0-29. Inverter will remain the setting before unlocked.

No.	Function	Range	Unit	Default	Type
F0-30	Inverter Model	0: Model G 1: Model P		0	○

F0-30=0 Set inverter as Model G which is applicable to mechanical or constant torque load.

F0-30=1 Set inverter as Model P which is applicable to square or cubic torque load like blower, and water pump.

★ When setting inverter as Model P, the applicable motor power refers to the Nameplate.

Note: The constant torque load is not applicable to Model P.

No.	Function	Range	Unit	Default	Type
F0-31	User Password	0~65535		XXXXXX	○

F0-31sets a password to start password protection and prevent unqualified personnel from editing the inverter parameters incorrectly. When password is 0, the password function is disabled.

8.2 F1 Group: Motor Parameters

No.	Function	Range	Unit	Default	Type
F1-00	Motor Type	0: AC induction motor 1: Not used		0	○
F1-01	Motor Rated Power	0.40~480.00	kW	XXXX	○
F1-02	Motor Rated Voltage	60~660	V	XXX	○
F1-03	Motor Rated Current	0.1~1500.0	A	XXXX	○
F1-04	Motor Rated Frequency	20.00~600.00	Hz	XXXX	○
F1-05	Motor Rated Speed	1~60000	rpm	XXXX	○
F1-06	Motor Wiring Mode	0:Y, 1: Δ		X	○
F1-07	Motor Rated Power Factor	0.50~0.99		X	○
F1-14	Motor Efficiency	30.0~99.0		XXX	○

Remarks:

When connecting the inverter to the motor at the first time, please set the above parameters as per the motor nameplate before operation.

No.	Function	Range	Unit	Default	Type
F1-08	Idling Excitation Current I0	0.1~1500.0	A	XXXX	○
F1-09	Rated Torque Current	0.1~1500.0	A	XXXX	×
F1-10	Stator Resistance R1	0.001~60.000	Ω	XXXX	○
F1-11	Rotator Resistance R2	0.001~60.000	Ω	XXXX	○

F1-12	Stator& Rotor Leakage Inductance Ls	0.1~3000.0	mH	XXXX	○
F1-13	Stator& Rotor Mutual Inductance Lm	0.1~3000.0	mH	XXXX	○

F1-08~F1-13 are motor parameters, please autotune motor parameter to obtain the above parameters. (F1-09 can be autotuned, but cannot be edited through keypad or communication.)

Before autotuning motor parameter, inverter will set the nameplate parameters (set by F1-00~F1-07) as the standard motor parameters automatically.

The T Equivalent Model of motor is as shown in Figure7-7.

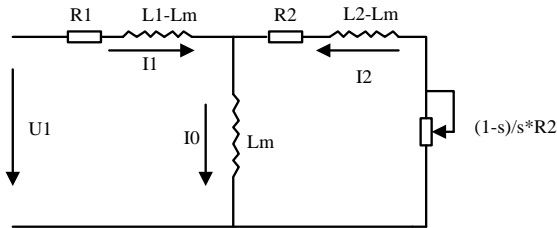

Figure 7-7 T Equivalent Model of Induction Motor

R1, L1, R2, L2, Lm, and I0 in Figure 7-7 refers to stator resistance, stator inductance, rotor resistance, rotor inductance, stator and rotor mutual inductance, and idling excitation current respectively.

No.	Function	Range	Unit	Default	Type
F1-15	Autotuning Parameters	0: No autotuning 1: Stationary autotuning (R ₁ ,R ₂ ,L _s ,L _m ,I ₀) 2: Rotational autotuning (R ₁ ,R ₂ ,L _s ,L _m ,I ₀)		0	○

F1-15=0 No autotuning

F1-15=1 Motor remains motionless in the process of autotuning parameters F1-07 and F1-10~F1-14.

F1-15=2 Motor is rotating in the process of autotuning parameters F1-07 and F1-10~F1-14.

- After parameters autotuning completed, F1-15=0 will be set automatically.
- When slip compensation is enabled, autotune motor parameter first, so that the motor will obtain the optimum operation performance.
- Parameter autotuning is only enabled when F0-04=0.

EM303B supports ModBus protocol, RTU format, and single-master and multi-slave communication network with RS485 bus.

No.	Function	Range	Unit	Default	Type
F1-16	Inverter Address	1~247, 0: Broadcasting Address		1	○

Inverter address code is the address code allocated to each inverter when the inverter is connected to the computer network. Each address code is unique in this network. The maximum number of inverter is 247 which are permitted to connect to the computer in one network.

F1-16=0 Address code is broadcasting address.

No.	Function	Range	Unit	Default	Type
F1-17	Communication Bit Rate	0: 4800 1: 9600 2: 19200 3: 38400	bps	1	○

F1-17=0 Communication Bit Rate: 4800bps

F1-17=1 Communication Bit Rate: 9600bps

F1-17=2 Communication Bit Rate: 19200bps

F1-17=3 Communication Bit Rate: 38400bps

No.	Function	Range	Unit	Default	Type
F1-18	Communication Parity Mode	0: No parity 1+8+1 for RTU 1: Even parity 1+8+1+1 for RTU 2: Odd parity 1+8+1+1 for RTU		0	○

F1-18=0 No parity

F1-18=1 Even parity

F1-18=2 Odd parity

No.	Function	Range	Unit	Default	Type
F1-19	Master-slave Communication Mode	0: The inverter is the slave 1: The inverter is the master		0	○
F1-20	Receiving Address of Slave Inverter	0: Primary Numeric Frequency F0-07 1: Auxiliary Numeric Frequency F9-06		0	○
F1-21	Inverter Receiving Proportion Coefficient	0.00~600.00	%	100.00	●

F1-19 Select the present inverter as the master or the slave.

F1-20 Set on the master inverter. Select the frequency setting command of slave inverter sent by master inverter, and then send F0-07 or F9-06 to the slave inverter.

F1-21 When the inverter is the slave, (the frequency sent by master inverter* F1-21) will be the setting numeric frequency of the slave inverter.

Remarks:

See Chapter 12 for EM303B ModBus communication protocol and examples.

No.	Function	Range	Unit	Default	Type
F1-22	Analog Input Gain K1	0.00~600.00	%	100.00	●
F1-23	Analog Input Gain K2	0.00~600.00	%	0.00	●

F1-24	Analog Input Gain K3	0.00~600.00	%	100.00	●
F1-25	Analog Input Gain K4	0.00~600.00	%	0.00	●
F1-26	Analog Input Gain K5	0.00~600.00	%	0.00	●
F1-27	Analog Input Gain K6	0.00~600.00	%	0.00	●
F1-28	Analog Input Gain K7	0.00~600.00	%	0.00	●
F1-29	Analog Input Gain K8	0.00~600.00	%	0.00	●

Set analog input gain K_i for proportional zooming of analog signals. The setting analog value of inverter: Analog input*Analog input gain K_i ($i=1\sim 8$). The description of F0-06, F5-11, F9-05 shows the correlation of 8 analog gain coefficients K_i and VP, VS, VF, IS, IF.

No.	Function	Range	Unit	Default	Type
F1-30	Communication Overtime	0.0-60.0(0.0:Disabled)	S	0.0	●

When exceeding the setting time of F1-30, inverter will stop if it does not receive the communication command from PC/PLC. Keypad displays fault EST. It can be defined as the multi-function output terminal action of inverter fault.

No.	Function	Range	Unit	Default	Type
F1-31	Master Communication Transmitting Data	0: Input frequency 1: Output frequency 2: Primary Numeric Frequency 3: Auxiliary Numeric Frequency 4: VP 5: VS 6: VF 7: IS 8: IF		0	●

If the inverter is set as the master, the source of slave frequency sent by the master is chosen through F1-31.

8.3 F2 Group: Input/output Terminal Parameters

The multi-function input terminals of EM303B are also called as numeric input terminals because of working in level or pulse mode.

No.	Function	Range	Unit	Default	Type
F2-00	Multi-function Input Terminal X1-RUN	See Table 6-1 Functions of Numeric Multi-function Input Terminals		1	○
F2-01	Multi-function Input Terminal X2-F/R			2	○
F2-02	Multi-function Input Terminal X3-D1			3	○
F2-03	Multi-function Input Terminal X4-D2			4	○
F2-04	Multi-function Input Terminal X5-D3			5	○

F2-05	Multi-function Input Terminal X6-FRS		9	○
F2-06	Multi-function Input Terminal X7-RST		10	○
F2-08	VS Input Function Defining	See FE-04 for setting of switching analog function to numeric function	0	○
F2-09	IS Input Function Defining		0	○
F2-10	VF Input Function Defining		0	○
F2-11	IF Input Function Defining		0	○

Multi-function input terminals X1~X7 are 7 programmable numeric input terminals. The function of X1~X7 can be defined by the setting value of F2-00~F2-06.

For example, set F2-00=1, then the function of terminal X1 is RUN-run. If start/stop control mode is in terminal control mode, when terminal X1 is on, inverter runs.

Xi=0No function

This function can be used to block the terminal when its hardware breaks down.

Xi=1 RUN-run

When start/stop control mode is terminal control (F0-04=1), if the function terminal is on, the inverter will run as per the setting value of F0-05.

Xi=2 F/R Forward/Reverse

When start/stop control mode is in terminal control mode (F0-04=1), if the function terminal is on, the inverter will forward/reverse as per the setting value of F0-05.

Xi=3 Preset Speed Terminal 1

Xi=4 Preset Speed Terminal 2

Xi=5 Preset Speed Terminal 3

Xi=6 Preset Speed Terminal 4

In preset speed control mode, 4 function input terminals can be defined as the preset speed terminals. A preset speed set in F3-00~F3-14 is selected as the present setting frequency of inverter by the programming coding of these 4 terminals. See 7.4 for preset speed options setting.

Xi=7 Acceleration/Deceleration Time Terminal 1

Xi=8 Acceleration/Deceleration Time Terminal 2

F0-09, F0-10, F3-15~F3-20 set acceleration/deceleration time 1~4, and select corresponding acceleration/deceleration time 1~4 through programming acceleration/deceleration terminals.

See 7.4 for the correlation of acceleration/deceleration time and its terminal.

Xi=9 Coast to stop

Inverter is running, if the function terminal is on, PWM output will be locked immediately, and then motor coasts to stop.

Xi=10 Inverter fault reset input

Inverter can be reset through fault reset terminal after inverter fault is cleared.

Xi=11 Forward Jog FJOG

Xi=12 Reverse Jog RJOG

Inverter will forward when terminal FJOG is on, reverse when terminal RJOG is on,

and stop when FJOG and RJOG are on simultaneously. See 7.1 for detail of Jog operation.

★ Reverse jog is disabled when reverse is prohibited.

Xi=13 UP: Terminal controls numeric frequency, and the stepping frequency rises.

Xi=14 DOWN: Terminal controls numeric frequency, and the stepping frequency drops.

During operation, if it is in stepping mode, the terminals are the hot keys for stepping frequency. Its speed rate can be set by F9-07.

Xi=15 Clearing the frequency enabled by UP/DOWN

Xi=16 Acceleration/Deceleration prohibited

When acceleration/deceleration prohibition terminal is on, acceleration/ deceleration command is prohibited, and the output frequency of inverter remains unchanged. When inverter is in overcurrent protection status, it runs as per the current limiting mode.

Xi=17 Ramp to stop

Xi=183-wire sequence stop control

The function is NC stop button of 3-wire sequence. See F0-05 for details of terminal start/stop options.

Xi=19 Not used

Xi=20 Switch drive control mode to V/F control mode

No matter what drive control mode F0-02 is in, if the terminal is on, the drive control mode will be switched to V/F control mode, and its function is equivalent to F0-02=0. When the terminal is off, it returns the previous control mode automatically.

Xi=21 Switch run command to terminal control

When the terminal is on, no matter what run command mode F0-04 is in, and what status of the run command input 0 or input 1 is, it is always in terminal control mode which is placed in the highest priority. The terminal control mode is set by F0-05.

Xi=22 Run command input 0

Xi=23 Run command input 1

The run command control modes can be selected through programming the run command inputs. See Table 7-1 for the correlation between run command control mode and run command input.

Table 7-1 Correlation between run command control mode and run command inputs

Run Command Input 0	Run Command Input 1	Run Command Control Mode
OFF	OFF	F0-04 Start/Stop Mode
OFF	ON	Keypad
ON	OFF	RS485
ON	ON	External Terminal

Programming mode of run command inputs is prior to F0-04 run command mode selection.

Xi=24 Switch input control mode to speed control mode

When the terminal is on, the present input control mode is switched to the speed control mode, and its function is equivalent to F0-03=0. After the terminal is off, inverter returns the previous input control mode automatically.

Xi=25 Switch input control mode to torque control mode

When the terminal is on, the present control mode is switched to torque control mode. Its function is equivalent to F0-03=1. After the terminal is off, inverter returns the previous input control mode automatically.



When the corresponding function terminals of Xi=24/25 are on simultaneously, terminal of Xi=24 is prior to terminal of Xi=25. If it is not set as SVC1, F0-02≠3, it cannot be switched to torque control.

Xi=26 Not Used

Xi=27 Switch speed input setting mode to primary speed setting mode

In speed control mode, if the terminal is on, and then integrated speed input mode is switched to primary speed setting mode. After the terminal is off, inverter returns the previous input mode automatically. It is equivalent to setting F9-03 ones place=0 when it is on.

Xi=28 Switch speed input setting mode to auxiliary speed setting mode

In speed control mode, if the terminal is on, then the speed input setting mode is switched to auxiliary speed setting mode. Its function is equivalent to setting F9-03 ones place =1. After the terminal is off, inverter returns the previous setting mode automatically.

Xi=29 Switch primary speed setting mode to regular speed setting mode

In speed control mode, if the terminal is on, then the primary speed setting mode is switched to regular speed setting mode. Its function is equivalent to setting F0-26=0. After the terminal is off, inverter returns the previous setting mode automatically.

Xi=30 Switch regular speed input setting mode to numeric speed input setting mode

In regular speed control mode, if the terminal is on, then the present regular speed setting mode of F0-06 is switched to the numeric speed input setting mode. Its function is equivalent to setting F0-06=0. After the terminal is off, inverter returns the previous setting mode automatically.

Xi=31 Switch jog input setting mode to jog numeric speed input setting mode

In regular speed control mode, if the terminal is on, then the present jog speed setting mode is switched to jog numeric speed input setting mode. Its function is equivalent to setting the tens place of F9-03=0. After the terminal is off, inverter returns the previous setting mode automatically.

Xi=32~34 Not used

Xi=35 Switch regular torque input setting to numeric torque input setting

In regular speed control mode, if the terminal is on, then the present regular torque setting mode is switched to the numeric torque input. Its function is equivalent to setting F5-11=0. After the terminal is off, inverter returns the previous setting mode automatically.

Xi=36 Not used

Xi=37 PID positive/negative function switch

In the process of process PID control operation, if the input signal of the function

terminal is on, then the function of PID regulator conducts positive/negative function switch. Its function is equivalent to adjusting parameters of F4-05.

Xi=38~43 Not used

Xi=44 Preset current limit terminal 1

Xi=45 Preset current limit terminal 2

Xi=46 Preset current limit terminal 3

When selecting preset current limit, 3 input terminals can be defined as the preset current limit terminals. Preset current limits set in FA-07~FA-13 are selected correspondingly through programming these 3 terminals. See Table 7-2 for correlation between preset current limits and the corresponding terminals.

Table 7-2 Correlation between preset current limit and the corresponding terminals

Terminal 3	Terminal 2	Terminal 1	Preset Torque Current Setting	Corresponding Torque Current Code
OFF	OFF	OFF	Non-preset Current Limit	Defined by FC-08
OFF	OFF	ON	Preset Current Limit 1	FA-07
OFF	ON	OFF	Preset Current Limit 2	FA-08
OFF	ON	ON	Preset Current Limit 3	FA-09
ON	OFF	OFF	Preset Current Limit 4	FA-10
ON	OFF	ON	Preset Current Limit 5	FA-11
ON	ON	OFF	Preset Current Limit 6	FA-12
ON	ON	ON	Preset Current Limit 7	FA-13

Xi=47 Start wobble operation

Wobble operation mode starts.

Xi=48 Not used

Xi=49 Program operation reset

When program operation (PLC) is enabled, if the input signal of this terminal is on, then the program operation time is cleared, and program operation starts from preset speed 1.

Xi=50 Alternate motor switching command

During running, if input signal of the terminal is on, the inverter regulates the output according to the parameters of Motor 2.

Xi=51 External fault input

During running, after the terminal receives external device fault signal, inverter stops and enters fault status. The default is set as NC input by FE-01(Terminal positive/ negative logic).

No.	Function	Range	Unit	Default	Type
F2-12	Multi-function Output Terminal Y1	See Table7-3		0	○
F2-13	Multi-function Output Terminal Y2	Functions of Numeric Multi-function Output Terminals		1	○
F2-14	Relay Output Terminal R1			9	○

EM303B provides 3 programmable output terminals including 2 multi-function output terminals and 1 relay output terminal. There are 0~32 program codes. User can define output variables of terminals.

2 multi-function output terminals are in OC output mode. Output common port is connected to COM. When selected program code is enabled, the electronic switch is ON, and when it is disabled, the electronic switch is OFF. OC can be powered either internally or externally, as shown in Figure 7-8(a) and 7-8(b) respectively. If it is externally powered, the voltage range is required to be within 8~24V.

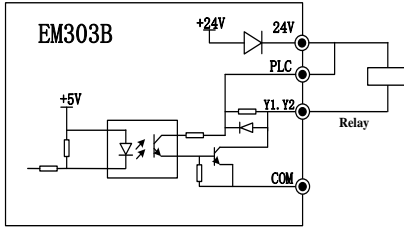

(a) Internal Power supply

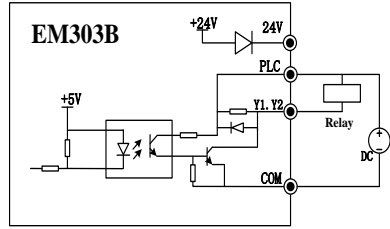

(b) External Power supply

Figure 7-8 Power Supply Modes of Programmable Terminals

Relay output is provided by the internal relay of inverter. Relay has 1 set of NO contacts and 1 set of NC contacts. When the selected programmable code is disabled, EB-EC is NC, and EA-EC is NO. When the selected program code is enabled, the coil of internal relay is power-on, EB-EC is off, and EA-EC is on, as shown in Figure 7-9.

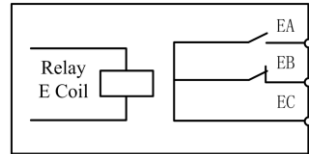

Figure7-9 Relay Contacts

Function of Y1, Y2 and R1 can be defined by setting the value of F2-12~F2-14. See Table 7-3 for the functions of numeric multi-function output terminals.

Table 7-3 Functions of Numeric Multi-function Output Terminals

No.	Function	Description
0	Inverter Runs (Enabled at Running)	When inverter is running, the output terminal is on.
1	Frequency Reach Range FAR (Enabled at running)	If $ \text{output frequency} - \text{setting input frequency} < \text{the setting value of F9-11}$, the output terminal is on. See 7.13.2 for details.
2	Output Frequency Detection Range FDT1(Enabled at running)	When inverter is running, if the output frequency increases to the value of F9-12 (FDT1 Increasing Threshold), the output terminal is on. If the output frequency drops and is less than the value of F9-13 (FDT1 Decreasing Threshold), the output terminal is off. See 7.13.3 for details.
3	Output Frequency Detection Range FDT2 (Enabled at running)	When inverter is running, if the output frequency increases to the value of F9-14 (FDT2 Increasing Threshold), the output terminal is on. If the output frequency drops and is less than the value of F9-15 (FDT2 Decreasing Threshold), the output terminal is off. See 7.13.3 for details.

No.	Function	Description
4	Output Frequency Detection Range FDT1 (Disabled at JOG)	When inverter is running (Except in JOG running mode), if the output frequency increases to the value of F9-12 (FDT1 Increasing Threshold), the output terminal is on. If the output frequency drops and is less than the value of F9-13 (FDT1 Decreasing Threshold), the output terminal is off. See 7.13.3 for details.
5	Output Frequency Detection Range FDT2 (Disabled at JOG)	When inverter is running (Except in JOG mode), if the output frequency increases to the value of F9-14 (FDT2 Increasing Threshold), the output terminal is on. If the output frequency drops and is less than the value of F9-15 (FDT2 Decreasing Threshold), the output terminal is off. See 7.13.3 for details.
6	Forward/Reverse (Enabled at Running)	When inverter is running, if the motor reverses, the output terminal is on. If the motor forwards, the output terminal is off.
7	Frequency Input/Output Balance (Enabled at Running)	When inverter is running, if output frequency= the setting frequency, the output terminal is on.
8	JOG	When inverter is jogging, the output terminal is on.
9	Inverter Fault	When inverter trips fault, the output terminal is on.
10	Upper Limit Frequency Reach(Enabled at Running)	When the output frequency of inverter reaches the setting upper limit frequency of F0-17, the output terminal is on.
11	Lower Limit Frequency Reach(Enabled at Running)	When the output frequency reached the lower limit frequency set by F0-18, the output terminal is on. (The output terminal will be off when accelerating to the lower limit frequency at the initial running. When the output frequency exceeds the lower limit frequency at the first time, and then reaches lower limit frequency again, the output terminal is on.)
12	Not Used	
13	Not Used	
14	Analog Variables Detection Range ADT1	If the input signal of analog input terminal> the value of ADT1 set by F7-05, the output terminal is on. See 7.9.2 for details.
15	Analog Variables Detection Range ADT2	If the input signal of analog input terminal> the value of ADT2 set by F7-07, the output terminal is on. See 7.9.2 for details.
16	Analog Variables Detection Range ADT3	If the input signal of analog input terminal> the value of ADT1 set by F7-09, the output terminal is on. See 7.9.2 for details.
17	Overload Alarming Output	When the present current of inverter exceeds the overload detection scale and the remaining time exceeds the overload detection time. See 7.9.1 for details.

No.	Function	Description
18	Overvoltage Stall	If overvoltage stall occurs, the output terminal is on.
19	Current Limit	If overcurrent stall occurs, the output terminal is on.
20	Frequency Zero Speed Detection(Output Frequency Detection)	When inverter is running, if the output frequency \leq the setting value of F9-09, inverter will be considered as running at zero speed, the output terminal is on.
21	Not Used	
22	Motor 2 Enabled	When motor 2 is selected as enabled (Motor is switched by multi-function numeric input terminal), the output terminal is on.
23	Setting running time is up	When the setting running time of Fd-27 is up, the output terminal is on.
24	Not Used	
25	Not Used	
26	Inverter is ready for running	When inverter is power-on normally and no fault occurs, the output terminal is on.
27	Not Used	
28	FDT1 lower bounds(pulse)	When output frequency falls below the setting value of FDT1 lower bounds, the corresponding terminal will output a pulse whose width is determined by the parameters set up in FE group.
29	FDT2 lower bounds(pulse)	When output frequency falls below the setting value of FDT2 lower bounds, the corresponding terminal will output a pulse whose width is determined by the parameters set up in FE group.
30	FDT1 lower bounds(void when JOG, pulse)	When output frequency falls below the setting value of FDT1 lower bounds, the corresponding terminal will output a pulse whose width is determined by the parameters set up in FE group. No pulse output in JOG state.
31	FDT2 lower bounds(void when JOG, pulse)	When output frequency falls below the setting value of FDT2 lower bounds, the corresponding terminal will output a pulse whose width is determined by the parameters set up in FE group. No pulse output in JOG state.
32	ILP Fault	When inverter trips the fault of input phase loss, the output terminal is on.

No.	Function	Range	Unit	Default	Type
F2-16	Analog Output Terminal M0	See Table 7-4	%	0	○
F2-17	Analog Output Terminal M1	Analog Output Full Scale	%	6	○

EM303B provides 2 programmable analog output terminals: M0 and M1 which can output 0~10V voltage signal or 0-20mA current signal by jump line selection. See Table 7-4 for analog outputs full scales and the description of F2-16~F2-27.

Remarks:

A in the formula below stands for 2 variables:

- 1, A=10V when the analog output is selected as voltage signal
- 2, A=20mA when the analog output is selected as current signal

Table 7-4 Analog Outputs Full Scales

No.	Signal	Full Scale (100.0%)	Description
0	Output Frequency	Fmax	Calculate the percentage= (output frequency/ Fmax)*100%*A as the analog output
1	Input Frequency	Fmax	Calculate the percentage= (input frequency/ Fmax)*100%*A as the analog output
2	Synchronous Frequency	Fmax	Calculate the percentage= (synchronous frequency/ Fmax)*100%*A as the analog output
3	Output torque (absolute value)	2 times motor rated torque	Take output torque as 2 times motor rated torque and then convert it to analog output.
4	Not Used		
5	Not Used		
6	Output Current	2 times inverter rated current	Calculate the percentage= (output current / 2 times of rated current of inverter)*100%*A as the analog output
7	Output Voltage	1.5 times inverter rated voltage	Calculate the percentage= (output voltage / 1.5 times of rated current of inverter)*100%*A as the analog output
8	VP	5.00V	Calculate the percentage= (VP input voltage/ 10.00V Voltage)*100%*A as the analog output
9	VS	10.00V	Calculate the percentage= (VS input voltage/ 10.00V Voltage)*100%*A as the analog output
10	VF	10.00V	Calculate the percentage= (VF input voltage/ 10.00V Voltage)*100%*A as the analog output
11	IS	20mA	Calculate the percentage= (IS input current/ 20mA current)*100%*A as the analog output
12	IF	20mA	Calculate the percentage= (IF input current/ 20mA current)*100%*A as the analog output
13	Output torque (actual value)	2 times motor rated torque	Take output torque as 2 times motor rated torque and then convert it to analog output
14	+10V	+10V	Output voltage+ 10V analog output, it is used as the base voltage of M0.
15	PID Input	PID Maximum Scale	Calculate the percentage= (PID input / 10.00V Voltage)*100%*A as the analog output
16	PID Feedback	PID Maximum Scale	Calculate the percentage= (PID feedback / 10.00V Voltage)*100%*A as the analog output
17	Not Used		
18	Not Used		

19	DC Bus Voltage	DC Bus Voltage at 1.5 Times Rated Input Voltage	Calculate the percentage= (DC bus voltage / the DC bus voltage at 1.5 times rated input voltage)*100%*A as the analog output
20	Output Power	inverter rated power	Calculate the percentage= (output power / rated power of inverter)*100%*A as the analog output
21	Feedback frequency /Output torque	Fmax/Motor rated torque	Feedback frequency output in speed mode, take the percentage of output frequency over the maximum frequency (Fmax) and then convert it to analogoutput. Torque output in torque mode, takes the percentage of output torque over motor rated torque and then converts it to analog output



1. In order to meet different needs of meters and external devices, the actual full scale voltage of M0/M1 is 10.9V, and the actual full scale current is 22mA.
2. Default of M0 and M1 is 0~10V.

3. If there is high demand for accuracy of analog output in application, please check idling output of M0 and M1 with multi-meter.

No.	Function	Range	Unit	Default	Type
F2-22	M0 Output Lower Limit	0.00~100.00	%	0.00	●
F2-23	M0 Output Upper Limit	0.00~100.00	%	100.00	●
F2-24	M0 Output Gain	0.00~300.00	%	95.00	●
F2-25	M1 Output Lower Limit	0.00~100.00	%	0.00	●
F2-26	M1 Output Upper Limit	0.00~100.00	%	100.00	●
F2-27	M1 Output Gain	0.00~300.00	%	95.00	●

Upper limit/lower limit of analog output can be set to meet different meters and requirements.

Final analog output signal= Output Lower Limit +Output gain*Analog output variables*(Output Upper Limit- Output Lower Limit)

Analog output gain and output upper/lower limit (F2-22~F2-27) are corresponding to terminals M0 and M1, and irrelevant to the current running status.

8.4 F3 Group: Preset Speed Operation Parameters

No.	Function	Range	Unit	Default	Type
F3-00	Preset Speed 1	0.00~Fmax/0.0~Fmax	Hz	0.00	●
F3-01	Preset Speed 2	0.00~Fmax/0.0~Fmax	Hz	5.00	●
F3-02	Preset Speed 3	0.00~Fmax/0.0~Fmax	Hz	10.00	●
F3-03	Preset Speed 4	0.00~Fmax/0.0~Fmax	Hz	15.00	●
F3-04	Preset Speed 5	0.00~Fmax/0.0~Fmax	Hz	20.00	●
F3-05	Preset Speed 6	0.00~Fmax/0.0~Fmax	Hz	25.00	●
F3-06	Preset Speed 7	0.00~Fmax/0.0~Fmax	Hz	30.00	●
F3-07	Preset Speed 8	0.00~Fmax/0.0~Fmax	Hz	35.00	●
F3-08	Preset Speed 9	0.00~Fmax/0.0~Fmax	Hz	40.00	●
F3-09	Preset Speed 10	0.00~Fmax/0.0~Fmax	Hz	45.00	●
F3-10	Preset Speed 11	0.00~Fmax/0.0~Fmax	Hz	50.00	●
F3-11	Preset Speed 12	0.00~Fmax/0.0~Fmax	Hz	50.00	●
F3-12	Preset Speed 13	0.00~Fmax/0.0~Fmax	Hz	50.00	●
F3-13	Preset Speed 14	0.00~Fmax/0.0~Fmax	Hz	50.00	●
F3-14	Preset Speed 15	0.00~Fmax/0.0~Fmax	Hz	50.00	●

Through preset speed control terminals and 15 preset frequency commands, EM303B can provide 16 preset speeds by combining keypad numeric setting mode and analog setting mode. Furthermore, it can be adjusted at any time through repeated addition analog input.

Setting Preset Speed Terminals

Terminal	No.	Default	Function
X3	F2-02	3	Preset Speed Terminal 1
X4	F2-03	4	Preset Speed Terminal 2
X5	F2-04	5	Preset Speed Terminal 3
X6	F2-05	6	Preset Speed Terminal 4
X7	F2-06	10	Inverter Fault Reset

Preset Speed Commands and Preset Speed Terminals

Speed	Preset Speed Terminal 4	Preset Speed Terminal 3	Preset Speed Terminal 2	Preset Speed Terminal 1	Selected Frequency	No.
1	OFF	OFF	OFF	OFF	Keypad or Analog Setting	Defined by F0-06
2	OFF	OFF	OFF	ON	Preset Speed 1	F3-00
3	OFF	OFF	ON	OFF	Preset Speed 2	F3-01
4	OFF	OFF	ON	ON	Preset Speed 3	F3-02
5	OFF	ON	OFF	OFF	Preset Speed 4	F3-03
6	OFF	ON	OFF	ON	Preset Speed 5	F3-04
7	OFF	ON	ON	OFF	Preset Speed 6	F3-05
8	OFF	ON	ON	ON	Preset Speed 7	F3-06
9	ON	OFF	OFF	OFF	Preset Speed 8	F3-07
10	ON	OFF	OFF	ON	Preset Speed 9	F3-08
11	ON	OFF	ON	OFF	Preset Speed 10	F3-09
12	ON	OFF	ON	ON	Preset Speed 11	F3-10
13	ON	ON	OFF	OFF	Preset Speed 12	F3-11
14	ON	ON	OFF	ON	Preset Speed 13	F3-12
15	ON	ON	ON	OFF	Preset Speed 14	F3-13
16	ON	ON	ON	ON	Preset Speed 15	F3-14

Precautions for setting:

- F0-04 defines start/stop of inverter in preset speed operation mode.
- The acceleration/deceleration time can be controlled by the external terminals set as the acc./dec. time function in preset speed operation mode.
- Terminals F/R and RUN determines the running direction of motor in preset speed operation mode.

No.	Function	Range	Unit	Default	Type
F3-15	Acceleration Time 2	0.00~600.00	S/min	15.00	●
F3-16	Deceleration Time 2	0.00~600.00	S/min	15.00	●
F3-17	Acceleration Time 3	0.00~600.00	S/min	15.00	●
F3-18	Deceleration Time 3	0.00~600.00	S/min	15.00	●
F3-19	Acceleration Time 4	0.00~600.00	S/min	15.00	●
F3-20	Deceleration Time 4	0.00~600.00	S/min	15.00	●

Acceleration time is the time taken for output frequency to rise from 0Hz up to the maximum frequency Fmax set by F0-16. Deceleration time is the time taken for output frequency to drop from Fmax down to 0Hz. Both of them are irrelevant to forward/reverse. EM303B provides 4 kinds of acceleration times and 4 kinds of deceleration times. Each of them is set by independent parameter. There are 2 multi-function input terminals which can be set as acceleration/deceleration time terminal 1 and 2. They are programmable when inverter is running. Changing their status, the acceleration/deceleration time can be changed

immediately. See Table 7-5 for the programming mode of acceleration/deceleration time terminal 1 and 2.

Table 7-5 Programming Mode of Acceleration/Deceleration Time Terminals

Acceleration/Deceleration Time Terminal 1	Acceleration/Deceleration Time Terminal 2	Acceleration Time/No.	Deceleration Time/No.
OFF	OFF	1 F0-09	1 F0-10
ON	OFF	2 F3-15	2 F3-16
OFF	ON	3 F3-17	3 F3-18
ON	ON	4 F3-19	4 F3-20

As shown in Table 7-5, acceleration/deceleration time refers to acceleration time 1 and deceleration time 1 in regular operation mode without using acceleration/deceleration terminal.

No.	Function	Range	Unit	Default	Type
F3-21	Acceleration/Deceleration Time Unit	0: S 1: min		0	○

F3-21=0 The unit of acceleration/deceleration time is second. The acceleration/deceleration time can be set continuously in the range of 0.00~600.00 seconds.

F3-21=1 The unit of acceleration/deceleration time is minute. The acceleration/deceleration time can be set continuously in the range of 0.00~600.00 minutes.

No.	Function	Range	Unit	Default	Type
F3-22	DC Brake Proportion at Start	0.00~30.00, 30.01~250.00	%	100.00	○
F3-23	DC Brake Time at Start	0.00~30.00	S	0.00	○

Before inverter starts, the motor may run in low speed or reverse. If inverter starts immediately at the moment, overcurrent may occur. In order to avoid such faults, please start DC brake to stop motor before inverter starts, and then the inverter runs to setting frequency as per setting direction.

F3-22 Different setting values can define different DC brake torques at start.

- If $F3-22 \leq 30.00$, the percentage base is the rated output voltage of inverter. While, the DC brake controls the DC voltage generated by motor windings.
- If $F3-22 \geq 30.01$, the percentage base is the rated output current of inverter. While, the DC brake controls the DC current generated by motor windings.
- If $F3-22 \leq 30.00$, inverter will trip overcurrent fault in the process of DC brake. Please reduce the value of F3-22 or set $F3-22 > 30.00$.

F3-23 Set the DC brake time at start. Inverter runs immediately when the time is up. If $F3-23=0.00$, DC brake is disabled at start.

★ The DC brake process at start is as shown in Figure 7-10.

	The function is applicable to that one inverter drives multi-motors.
---	--

No.	Function	Range	Unit	Default	Type	
F3-24	DC Brake Start Frequency at Stop	0.10~60.00/0.1~60.0	Hz	2.00	○	
F3-25	DC Brake Proportion at Stop	0.00~30.00, 30.01~250.00	%	100.00	○	
F3-26	DC Brake Waiting Time at Stop	0.10~30.00	0~15 kW	S	0.40	○
			15~110 kW		0.70	
			110~400 kW		1.00	
F3-27	DC Brake Time at Stop	0.00~30.00	S	0.00	○	

F3-24 Set the frequency for starting DC brake in the process of ramp-to-stop. Once the output frequency is lower than this frequency in the process of ramp-to-stop, if DC brake time≠0, then DC brake is enabled at stop.

F3-25 Different setting values can define different DC brake torques at stop.

- If $F3-25 \leq 30.00$, the percentage base is the rated output voltage of inverter. While, the DC brake controls the DC voltage generated by motor windings.
- If $F3-25 \geq 30.01$, the percentage base is the rated output current of inverter Model G. While, the DC brake controls the DC current generated by motor windings.

F3-26 when DC brake command given by the terminal is active at stop or the output frequency reaches the setting value of F3-24 in the process of ramp-to-stop. DC brake enabled after the time set by F3-26 is up.

F3-27 Set DC brake time at stop. If $F3-27=0.00$, the DC brake is disabled at stop.

- If there is a DC brake signal of external terminal at stop, then the DC brake time at stop takes the greater between the active time of the DC brake signal of external terminal at stop and the setting time of F3-27.
- The process of DC brake at stop is as shown in Figure 7-11.

- | | |
|---|---|
|  | <p>1. For heavy load, regular deceleration cannot stop motor fully due to inertia, and motor could be stopped by prolonging the DC brake time or increasing DC brake current at stop.</p> <p>2. For potential energy load, DC brake current control mode cannot be applied due to the rising time of current.</p> |
|---|---|

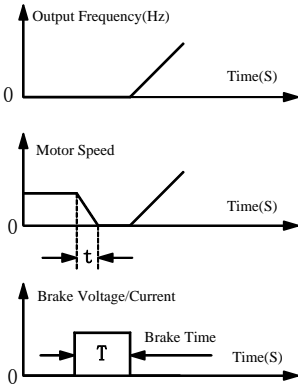

Figure 7-10 DC Brake Process at Start

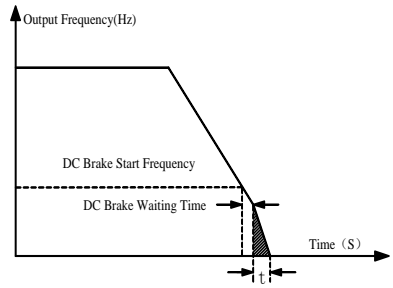

Figure 7-11 DC Brake Process at Stop

No.	Function	Range	Unit	Default	Type
F3-28	Lower Limit Frequency Control	0: Run as per the lower limit frequency 1: Run at zero speed after lower limit frequency running time is up.		0	○
F3-29	Lower Limit Frequency Running Time	0.00~600.00	S	60.00	○

F3-28=0 If output frequency < lower limit frequency, the inverter will always run as per lower limit frequency. The lower limit frequency is set by F0-18.

F3-28=1 If output frequency < lower limit frequency, the inverter runs per lower limit frequency first, and then runs at zero speed after the lower limit frequency running time reaches the setting value of F3-29. The function is applicable to process PID control like constant pressure water supply, air compressor, and etc.

See Figure 7-12 for lower limit frequency control.

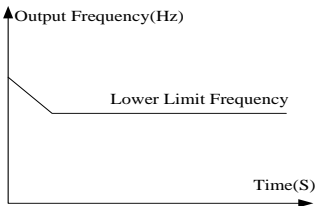

F3-28=0

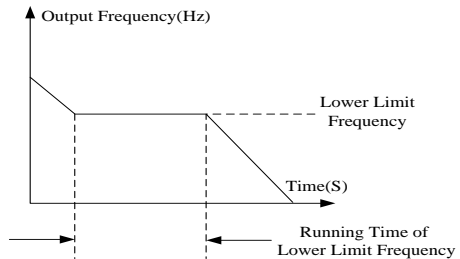

F3-28=1

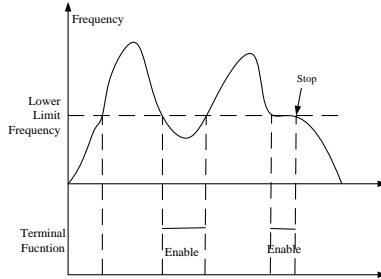



Figure 7-12 Lower Limit Frequency Control

No.	Function	Range	Unit	Default	Type
F3-30	Open Loop Slip Compensation	0.00~200.00	%	100.00	●
F3-31	Parameter Copy	0: No Copy 1: Upload Parameter (From Inverter to Keypad) 2:Download Parameter (From Keypad to Inverter)		0	○

F3-31=0 No copy.

F3-31=1 Upload the parameters from the control panel of inverter to the EEPROM in keypad. Upon the completion of uploading, F3-31=0 is set automatically.

F3-31=2 Download the parameters from the EEPROM in keypad to the control panel of inverter. Upon the completion of downloading, F3-31=0 is set automatically.

 The function may be applied to the setting parameter copy between different inverters, and to save the initial parameters defined by user. When the parameters are edited by mistake, the inverter cannot work normally, please download the parameter to reset user parameters.

8.5 F4 Group: General Parameters of PID

PID control is a close-loop control mode, which feedbacks the output signal of control object in the system to PID controller, and then form one or more close-loops by regulating the output of controller after PID calculation. PID control is to make the output value of control object in the system identical to the setting target value.

Based on the error between system setting target and feedback signal, PID controller computes the control variables with proportion, integration and differentiation. The characteristics of each computing factor are as follows:

Proportion (P):

Proportional control is a simplest control mode. The output and input error signal of its controller is in proportional relation. The stable errors of system output exist in proportional control mode only.

Integration (I):

In integration control mode, the output and input error signal integration of controller is in direct ratio. It can eliminate stable error and keep the system away from stable errors after entering stable status, but sharp changes cannot be tracked.

Differentiation (D):

In differentiation control mode, the output and input error signal differentiation (i.e. the change ratio of error) of controller is in direct ratio. It can forecast the trend of error change with quick response, and improve the dynamic performance of system in the process of regulation.

★Stable error refers to the difference between the expected output of system and the actual output after system response is stable.

See Figure 7-13 for the function of three computing factors in PID control mode.

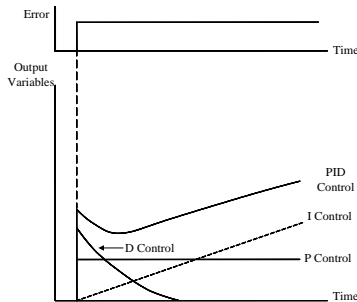

Figure 7-13 Function of PID Control

EM303B PID Control Logic

Control logic of internal process PID of EM303B is as shown in Figure 7-14. Through PID close-loop control, an inverse feedback control system is formed between EM303B and control object.

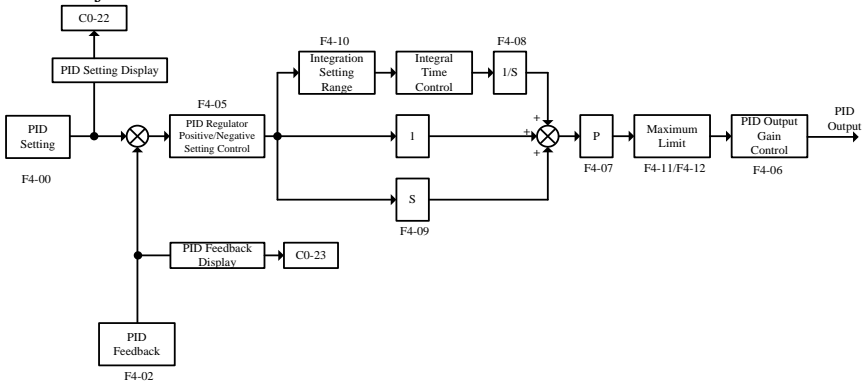

Figure 7-14 Internal Process PID Control Logic of EM303B

Process PID control can form speed PID close-loop control (taking speed as control object) and torque PID close-loop control system (taking torque current as control object).

Set F0-03=0 and F0-26=2, i.e. the inverter can be set as speed process PID control mode.
The control object is the speed of motor.

No.	Function	Range	Unit	Default	Type
F4-00	PID Regular Setting Mode	0: Numeric PID Setting 1: VS 2: IS 3: VF 4: IF 5: VP		0	○
F4-01	PID Numeric Setting	0.0~PID Maximum Scale	V	0.0	●

Setting Channel Options

F4-00=0 Numeric PID setting. Input PID setting value by editing F4-01 parameters through keypad.

F4-00=1 Take input voltage of analog input terminal VS as PID setting value.

F4-00=2 Convert the input current of analog input terminal IS into the voltage, and then take the voltage as PID setting value.

F4-00=3 Take input voltage of analog input terminal VF as PID setting value.

F4-00=4 Convert the input current of analog input terminal IF into the voltage, and then take the voltage as PID setting value.

F4-00=5 Take VP input voltage set by keypad potentiometer as PID setting value.

PID Numeric Setting

The data of F4-01 can be directly input by keypad as PID setting value.

No.	Function	Range	Unit	Default	Type
F4-02	PID Feedback Options	0: VF 1: IF 2: VS 3: IS		0	○

PID feedback signal is input by the analog input terminal. The feedback value can be operated mathematically based on real needs.

F4-02=0 VF input voltage is PID feedback.

F4-02=1 IF input current is PID feedback.

F4-02=2 VS input voltage is PID feedback.

F4-02=3 IS input current is PID feedback.

No.	Function	Range	Unit	Default	Type
F4-03	PID Maximum Scale	0.1~6000.0		10.0	●

F4-04	Positive/Negative Options of PID Upper/Lower Limit	Ones place: PID Upper Limit Options 0: Positive 1: Negative Tens place: PID Lower Limit Options 0: Positive 1: Negative		10	●
--------------	--	--	--	----	---

F4-03 determines the maximum scale of PID setting signal and feedback signal.

F4-04 determines the positive/negative options of PID output upper/lower limit.

	F4-04 cannot be set as 1. Please set PID output upper limit < PID output lower limit.
---	---

No.	Function	Range	Unit	Default	Type
F4-05	PID Regulation Setting	0: Positive Setting 1: Negative Setting		0	○

F4-05=0 Positive setting, i.e. error and output are positive.

F4-05=1 Negative setting, i.e. error is positive, output is negative.

- If feedback signal > the setting value of PID, the output frequency of inverter is required to drop in order to make PID reach balance. Take water supply as an example. If the pressure increases, the feedback of pressure increases. The output frequency of inverter needs to drop for reducing pressure and keeping pressure constant. While, PID should be in positive setting.
- If feedback signal > the setting value of PID, the output frequency of inverter is required to rise in order to make PID reach balance. Take temperature control as an example, PID regulator should be under negative setting control.

No.	Function	Range	Unit	Default	Type
F4-06	PID Output Gain	0.00~100.00	%	100.00	●

F4-06 Output gain is to regulate the PID output function range. The unit is %.

No.	Function	Range	Unit	Default	Type
F4-07	Proportional Gain GP	0.00~100.00		0.40	●
F4-08	Integral Time GTi	0.00~300.00 0.00:No integration	S	10.00	●
F4-09	Differential Time GTd	0.00~100.00	mS	0.00	●

F4-07 Proportion gain GP is the proportion gain of PID close-loop control algorithm.

F4-08 Integration time constant GTi is the integration time constant of PID close-loop control algorithm. When integration time constant is 0, integration function is disabled.

F4-09 Differentiation time GTd is the differentiation time constant of PID close-loop control algorithm.

No.	Function	Range	Unit	Default	Type
F4-10	Integration Function Scale	0.00~100.00	%	100.00	●

F4-10 Integration function scale: When error between PID setting value and feedback is greater than the setting value, there is no integral operation.

1. Setting value of F4-10= (PID setting value - Feedback)/PID Scale
2. Set inverter in the process PID closed-loop control mode, and regulate the parameters of PID controller based on the output waveforms through the output of feedback signal monitoring system. Generally, regulation follows the rules:
3. Increase the proportional gain GP within the range of non-oscillation output.
4. Shorten integration time constant GTi within the range of non-oscillation output.
5. Prolong differentiation time constant GTd within the range of non-oscillation output.

After all PID parameters set, all of them can be slightly adjusted by following steps:

Output overshoot suppression: Shorten the differentiation time GTd, and prolong the integration time GTi, as shown in Figure 7-15.

Output periodic oscillation suppression: Shorten the differentiation time GTd or set it as zero, and reduce proportion gain GP, as shown in Figure 7-16.

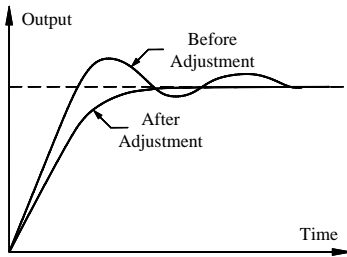

Figure 7-15
Output overshoot Suppression

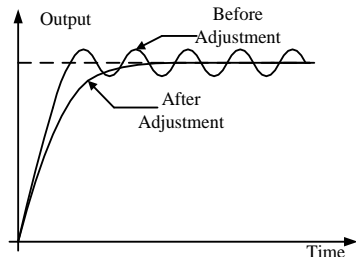

Figure 7-16
Output periodic oscillation suppression

No.	Function	Range	Unit	Default	Type
F4-11	PID Upper Limit	0.00~100.00	%	100.00	●
F4-12	PID Lower Limit	0.00~100.00	%	0.00	●

F4-11 limits the range of positive PID output. If PID setting value>PID feedback continuously, PID operation will not proceed when reached the limit.

F4-12 limits the range of negative PID output. If PID setting value<PID feedback continuously, PID calculation will not proceed when reached the limit.

No.	Function	Range							Unit	Default	Type
F4-15	Monitoring	*	Iq	E-Slip	E-Speed	*	F _s	F _I	F _O		11111111 ●
	Reference	0	0	0	0	0	0	0	0		
	Options	0: Absolute Value, 1: +/-									

Bit setting value=0

Monitoring frequency shows absolute value when motor forwards/reverses.

Bit setting value=1

Monitoring frequency shows positive/negative value when motor forwards/ reverses.

F4-15 is bit operation, only set corresponding bit of monitoring frequency = 0/1.

For instance: when motor forwards/reverses, the monitoring output frequency and estimated slip frequency shows positive/negative value respectively, but monitoring the other frequency shows absolute value, only set the 0th bit=1 (corresponding to the output frequency) and the 5th bit=1 (corresponding to the estimated slip), and set other bits = 0, i.e. F4-15=XX10X001.



No.	Function	Range	Unit	Default	Type
F4-16	LCD Language Options	0: Chinese, 1: English		0	○

F4-16=0 Chinese

F4-16=1 English

Remarks: The standard keypad is LED keypad.

No.	Function	Range	Unit	Default	Type
F4-18	If Parameters Change with Inverter's Working Status	0: Unchanged 1: Changed		1	○
F4-19	Parameter Setting Display	0~575		0	●

F4-18=0 When setting parameters, press  and  on keypad, the one which remains unchanged is the monitoring parameter. For example, set F0-07=50Hz, and F0-11=5.00Hz, press  key, the setting value F0-07 displays as 50Hz, then it would not show JOG monitoring parameter.

F4-18=1 When setting parameters, press  and  on keypad, the present display changes as the monitoring parameter.

F4-19 Forsetting the parameter displayed on keypad when inverter returns parameter setting status. For example: when inverter stops, the parameter displayed on keypad. The default is corresponding to the value of F0-00.

No.	Function	Range	Unit	Default	Type
F4-20	Parameters displayed in the 1 st row in operation	0~575		512	●
F4-21	Parameters displayed in the 2 nd row in operation	0~575		514	●
F4-22	Parameters displayed in the 3 rd row in operation	0~575		524	●
F4-23	Parameters displayed in the 4 th row in operation	0~575		525	●
F4-24	Parameters displayed in the 1 st row at stop	0~575		512	●
F4-25	Parameters displayed in the 2 nd row at stop	0~575		514	●
F4-26	Parameters displayed in the 3 rd row at stop	0~575		524	●
F4-27	Parameters displayed in the 4 th row at stop	0~575		528	●

Selecting the parameters need to be displayed in running and at stop



1. Defaults are selected to display the data of C0-00, C0-02, C0-12, C0-13, and C0-16 in C0 Group.
2. If there is no LCD keypad, F4-20 and F4-24 are enabled only.

No.	Function	Range	Unit	Default	Type
F4-30	PID Feedback Loss Detection Value	0.0~PID maximum scale		0.0	○
F4-31	PID Feedback Loss Detection Time	0.0~6000.0	S	6000.0	○

F4-30 and F4-31 are for judging whether PID feedback is lost or not.

If PID feedback < PID feedback loss detection value F4-30 (Because of AD sampling accuracy, please do not set F4-30=0.1 or 0.2), and lasting time > PID feedback loss detection time (F4-31), inverter trips EST (PID feedback loss) and will take the corrective action based on selected troubleshooting.

8.6 F5 Group: General Parameters of Vector Control

No.	Function	Range	Unit	Default	Type
F5-00	Speed Proportional Gain ASR_P1	0.00~100.00	%	15.00	●
F5-01	Speed Integral Time ASR_Ti1	0.00~30.00 0.00: No integration	S	0.50	●
F5-02	Speed Differential Time ASR_Td1	0.00~10.00	mS	0.00	●
F5-03	Speed Proportional Gain ASR_P2	0.00~100.00	%	12.00	●
F5-04	Speed Integral Time ASR_Ti2	0.00~30.00 0.00: No integration	S	0.50	●
F5-05	Switching Frequency 0	0.00~Switching Frequency 1	Hz	5.00	○
F5-06	Switching Frequency 1	Switching Frequency 0~Fmax	Hz	10.00	○

In SVC1, inverter adjusts the speed dynamic response of vector control through regulating speed proportional gain, speed integral time and speed differential time of speed PID regulator. The dynamic response of speed loop can be accelerated by increasing speed proportion gain, shortening speed integration time or prolonging speed differentiation time. However, if speed proportional gain is too big, speed integral time is too little, or speed differential time is too much, all of which will result in big system overshoot so that oscillation occurs.

User should adjust above speed PID parameters according to the real load features. Usually, on the premise of no system oscillation, proportional gain can be increased as much as possible, and then adjust integral time and differential time to enable the system to have quick response with small overshoot.

To ensure system quick dynamic response at both low speed and high speed, PID regulation needs to be conducted at low speed and high speed respectively. If it is below switching

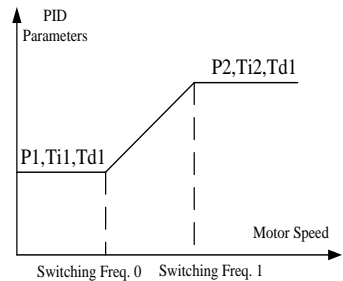

Figure 7-17
Illustration of PID parameters

frequency 0, the parameters of speed PID are P1, Ti1 and Td1, and above switching frequency 1, the parameters of speed PID are P2, Ti2 and Td1. If switching frequency 1 (F5-06) > switching frequency 0 (F5-05), then the process is linear transition process from switching frequency 0 to switching frequency 1, as shown in Figure 7-17.

1. Be careful to edit the parameters of F5-00~F5-06.
2. When setting switching frequency, switching frequency 0(F5-05) ≤ switching frequency 1(F5-06).

Torque control (SVC1)

EM303B could conduct torque control in SVC1.

When EM303B runs in SVC1 mode, torque control function refers to the occasions when the excitation current of motor is in current closed-loop, the actual motor speed can be estimated in real time through the internal motor magnetic flux and the speed estimation function of inverter, thus motor torque current can be actively controlled. Furthermore, the output torque of output motor can be controlled.

When EM303B runs in SVC1, the maximum output frequency is limited by torque control upper limit frequency (F5-14). When the setting torque of inverter is bigger than the load torque, the output frequency rises. When the output frequency reaches the upper limit frequency of torque control, inverter always runs as per upper limit frequency, and when the setting torque of inverter is less than the load torque, the output frequency drops.

No.	Function	Range	Unit	Default	Type
F5-07	Torque Current Acceleration Time	0.000~30.000	S	0.040	●
F5-08	Torque Current Deceleration Time	0.000~30.000	S	0.040	●

F5-07 Time taken for torque current to rise from 0 up to rated torque current.

F5-08 Time taken for torque current to drop from rated torque current down to 0.

No.	Function	Range	Unit	Default	Type
F5-09	Power Torque Current Limit	80.00~250.00	%	165.00	●
F5-10	Brake Torque Current Limit	80.00~250.00	%	165.00	●

F5-09 and F5-10 are for setting the current limit condition. If the output current of inverter > the setting values of F5-09 and F5-10, current limit is enabled, thus the output current can be controlled within current limit.

- ★ The parameters refer to the ratio of the output current (at current limit) to the rated output current of inverter.
- ★ Customer can set the current limit based on actual needs to protect motor or meet the working requirements.

F5-09 and F5-10 limit the torque limiting

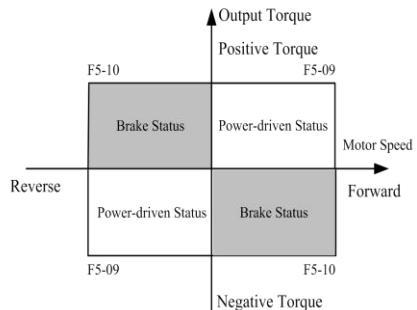

Figure 7-18
Current Limit of Power /Braking Torque

current in power-driven and brake status respectively. See Figure 7-18.



1. If the setting torque current and rotation of motor are in the same direction, the torque current is the power torque current.
2. If the setting torque current and rotation of motor are opposite, the torque current is the brake torque current.

No.	Function	Range	Unit	Default	Type
F5-11	Regular Torque Setting	0: Primary Numeric Torque Setting 1: VP 2: VS 3: IS 4: VF 5: IF 6: Not used 7: $K1*VP+K2*(K3*VS+K4*IS+K5*VF+K6*IF-K8*5V)$		0	○
F5-12	Primary Numeric Torque Current	0.00~Maximum torque	%	0.00	●
F5-13	Torque Direction	0: Positive Torque 1: Negative Torque		0	●

Torque Setting Options

F5-11=0 Numeric torque current setting. Input the setting value of torque current by editing F5-12 parameters through keypad.

F5-11=1 Keypad potentiometer sets the VP input voltage as the setting value of torque current.

F5-11=2 Input voltage of analog input terminal VS is the setting value of torque current.

F5-11=3 Input current of analog input terminal IS is the setting value of torque current.

F5-11=4 Input voltage of analog input terminal VF is the setting value of torque current.

F5-11=5 Input current of analog input terminal IF is the setting value of torque current.

F5-11=7 Combine all analog values as the setting value of torque current, and then adjust corresponding proportion according to each coefficient.

F5-12 Input as the setting value of torque current by keypad directly. The setting value refers to the percentage of torque current output and the rated torque current of motor.

F5-13=0 Torque is positive which is in the same direction of motor rotation.

F5-13=1 Torque is negative which is opposite to the direction of motor rotation.

No.	Function	Range	Unit	Default	Type
F5-14	Upper Limit Frequency Limiting of Torque	0: Upper Limit Frequency 1: $VS*Upper\ Limit\ Frequency$ 2: $IS*Upper\ Limit\ Frequency$ 3: $VF*Upper\ Limit\ Frequency$ 4: $IF*Upper\ Limit\ Frequency$		0	○

In torque control mode, the inverter controls the torque current of motor, so the motor speed is beyond control. If the input torque command does not match the load, the motor may accelerate or decelerate in opposite direction continuously. F5-14 is to limit the motor speed threshold in torque control mode. When the motor reaches the speed threshold, torque current is determined by the load torque, but beyond control of the torque current setting value, i.e. the speed will not rise and remain the threshold. If motor speed drops, the torque current will be controlled by setting value again.

F5-14=0 Defined by upper limit frequency (F0-17).

F5-14=1 Defined by VS^* upper limit frequency.

F5-14=2 Defined by IS^* upper limit frequency.

F5-14=3 Defined by VF^* upper limit frequency.

F5-14=4 Defined by IF^* upper limit frequency.



The analog signal here means gain.
Gain value= Voltage/10*100% or current/20* 100%.

No.	Function	Range	Unit	Default	Type
F5-15	Static friction compensation coefficient	0.00~150.00	%	0	●
F5-17	Static friction acting cut-off frequency	0.00~50.00	Hz	2.00	○

In torque mode, the system with large inertia or static friction coefficient generally requires sufficient torque to get a start. The torque compensation against static friction can be acquired by F5-15 and F5-17 together.

Static friction coefficient refers to the additional torque value in normal torque setting. Starting torque can be regulated by this code.

After estimated frequency reaches at static friction acting cut-off frequency, static friction compensation is out of effect, and the motor runs as per normal torque setting.

No.	Function	Range	Unit	Default	Type
F5-20	Gain of VVF Excitation Current Regulation	0~60000		0	●
F5-21	Integral Time of VVF Excitation Current Regulation	0.00~600.00	mS	0.00	●

F5-20 and F5-21 are the parameters of vector control excitation current regulator, and will affect system performance and stability directly. User does not need to change the defaults on general conditions.

No.	Function	Range	Unit	Default	Type
F5-22	Positive/Negative Torque Control	0: Positive/Negative Torque Permitted 1: Negative Torque Prohibited		0	○
F5-23	Positive/Negative Torque Deadband Time	0.00~600.00	S	0.00	○

F5-22=1 Negative torque prohibited.
F5-13 and F5-23 will be blocked.
F5-22=0 Negative torque permitted.
F5-13 defines the torque output direction.
F5-23 is for setting the transit time at zero output torque for the inverter in the process of switching positive and negative torque.
See Figure 7-19.

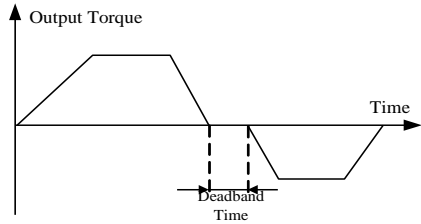



Figure 7-19
Deadband of Positive/Negative Torque

The torque direction refers to the setting direction of torque current, but not the rotational direction of motor.

- | | |
|--|--|
|  | <ol style="list-style-type: none"> 1. The default forward direction of motor is the positive torque direction. 2. If positive/negative torque switching is applied in torque program operation mode, it cannot be switched by terminals. |
|--|--|

No.	Function	Range	Unit	Default	Type
F5-24	Current Loop Gain ACR_P	0.00~10.00	%	0.40	●
F5-25	Current Loop Integration ACR_Ti	0.00~300.00	mS	10.00	●

F5-24 and **F5-25** are PID regulator parameters of torque current, and will affect system performance and stability directly. User does not need to change the defaults on general conditions.

No.	Function	Range	Unit	Default	Type
F5-27	Control Mode at Zero Frequency	0: Brake		2	○
		1: Normal			
		2: No output			

F5-27 is for the control mode of inverter output frequency near zero frequency.
F5-27=0 Brake current at zero frequency can be set by F7-31, and it will make motor not be driven by the load when the output frequency of inverter is zero frequency.
F5-27=1 Normal output control.
F5-27=2 There is no output near zero frequency. Motor can rotate freely.

No.	Function	Range	Unit	Default	Type	
F5-26	Closed-loop Slip Compensation Gain	50.00~200.00	%	100.00	●	
F5-29	Excitation Gain Kd	100.00~600.00	0~9kW	%	100.00	●
			9~30kW		150.00	
			30~55kW		200.00	
			55~75kW		300.00	
			75~110kW		400.00	
			110~400kW		500.00	

F5-30	Set-up Time of Excitation Gain	0.00~10.00	0~9kW	S	0.10	○
			9~55kW		0.15	
			55~400kW		0.20	

Pre-excitation is for motor magnetic field set-up. The default can meet the needs. User does not need to change the defaults on general conditions.

No.	Function	Range	Unit	Default	Type
F5-31	Maximum Torque	50.00~250.00	%	100.00	○

F5-31 Tmax indicates the maximum setting torque permitted by inverter. Range of Tmax: 50.00%~250.00%.

8.7 C0 Group: Parameters of Monitoring Function

When EM303B is running, operation parameters can be acquired by checking monitoring parameters in Group C0. All monitoring parameters are read only.

When inverter is running, F4-20 defines the default of displayed monitoring parameter.

The display of motor rotating direction can be set when monitoring frequency.

No.	Function	Range	Unit
C0-00	Output Frequency	Present output frequency of inverter	Hz
C0-01			
C0-02	Input Frequency Torque Upper Limit Frequency	Present setting frequency of inverter	Hz
C0-03			
C0-04	Synchronous Frequency	Actual output frequency of inverter	Hz
C0-05			
C0-06	Not Used		
C0-07	Not Used		
C0-08	Estimated Feedback Frequency	Motor running frequency estimated by inverter	Hz
C0-09			
C0-10	Estimated Slip Frequency	Slip frequency estimated by inverter	Hz
C0-11			
C0-12	Output Current Percentage	Output current percentage of inverter	%
C0-13	Effective Output Current Value	Effective output current of inverter	A
C0-14	Output Voltage Percentage	Output voltage percentage of inverter	%
No.	Function	Range	Unit
C0-15	Effective Output Voltage Value	Effective output voltage of inverter	V
C0-16	DC Bus Voltage	DC bus voltage of inverter	V
C0-17	Output torque percentage	Motor output torque	%
C0-18	Not Used		
C0-19	Program Operation Section	Present section of program operation	SECT
C0-20	Running Time of Present Section of Program Operation	In program operation, the unit of running time at present operation section is up to the ten thousand's place	S/min

		of F6-00.						
C0-21	Output Power	Present output power						kW
C0-22	PID Input	PID setting						
C0-23	PID Calculation Feedback	PID feedback						
C0-24	Torque Current Input Iq*	Present torque current input setting value						%
C0-25	Torque Current Feedback Iq	Present output torque current value						%
C0-26	Input Terminal Status	X7	X6	X5	X4	X3	X2	X1
		0	0	0	0	0	0	0
		X1 is the LSB. (Monitoring the logic status of external input terminals)						
C0-27	Output Terminal Status	*	*	*	*	R1	Y2	Y1
		0	0	0	0	0	0	0
		Y1 is the LSB. (Monitoring the logic status of output terminals)						
C0-28	VS Input Monitoring	0-10000						
C0-29	IS Input Monitoring	0-10000						
C0-30	VF Input Monitoring	0-10000						
C0-31	IF Input Monitoring	0-10000						

Section 2 Advanced Parameters

8.8 F6 Group: Simple PLC Function

8.8.1 Options of Program Operation Mode and Time Unit

No.	Function	Range	Unit	Default	Type
F6-00	Program Operation Mode	<p>Ones place: Options of programmable speed operation mode 0: Monocycle 1: Run as per Preset Speed 7 after monocycle 2: Limited times of continuous cycle 3: Continuous cycle</p> <p>Tens place: Not used Hundreds place: Not used Thousands place: Options of restart after operation paused 0: Restart from the section when it paused 1: Restart from Preset Speed 1</p> <p>Ten thousands place: Program operation time unit 0: S 1: min</p>		00000	○
F6-15	Speed Cycling Times	1~10000		1	●

Speed Program Operation Mode Selection

F6-00 ones place=0 Monocycle.

Inverter will stop after running as per the time and operation of 7 preset speeds.

F6-00 ones place=1 Run as per Preset Speed 7 after monocycle

Inverter will run as per the preset speed 7 after running as per the time and operation of 7 preset speeds.

F6-00 ones place=2 Limited times of continuous cycle

Inverter will run as per the preset speed 1 after running as per the time and operation of 7 preset speeds, and will stop after the cycling operation reached setting times. F6-15 sets the speed cycling times.

F6-00 ones place=3 Continuous cycle

After running as per the time and operation of 7 preset speeds, inverter will run as per the preset speed 1. Unless the inverter gets the stop command, it will run from preset speed 1 to preset speed 7 circularly.

Remarks: The preset speeds stated here are corresponding to the preset frequencies in F3 Group.

Options of restart after operation paused

F6-00 thousands place=0 Options of restart after operation paused

In the process of program operation, if the external pause input is enabled, power fails or fault occurs, inverter will re-enter operation status and run as per the preset speed at pause.

F6-00 thousands place=1 Restart from Preset Speed 1

In the process of program operation, if the external pause input is enabled, power fails or fault occurs, inverter will re-enter operation status and run as per the preset speed 1.

Program operation time unit

F6-00 ten thousands place=0

Program operation time unit: Second

F6-00 ten thousands place =1

Program operation time unit: Minute

8.8.2 Set the Acc./Dec. Time/Mode/Saving Options at Power-Failure for Each Section

No.	Function	Range	Unit	Default	Type
F6-01	Preset Program Operation Section 1	Ones place: Motor running direction options		100	○
F6-02	Preset Program Operation Section 2	0: Forward 1: Reverse		100	○
F6-03	Preset Program Operation Section 3	Tens place: Options of acceleration /deceleration time		100	○
F6-04	Preset Program Operation Section 4	0: Acceleration / Deceleration time 1 1: Acceleration / Deceleration time 2		100	○
F6-05	Preset Program Operation Section 5	2: Acceleration / Deceleration time 3 3: Acceleration / Deceleration time 4		100	○

F6-06	Preset Program Operation Section 6	Hundreds place: Saving options at power failure in program operation		100	○
F6-07	Preset Program Operation Section 7	0: Not Saved 1: Saved		100	○

In program operation, the direction and acceleration/deceleration time of each preset section can be set separately. The following description is taken F6-01(Preset Program Operation Section 1) as an example. The setting method of the other sections is the same.

Options of motor running directions

F6-01 ones place=0 Forward

Motor forwards as per positive torque output by inverter.

F6-01 ones place=1 Reverse

Motor reverses as per negative torque output by inverter.

- If F0-24 is set as reverse prohibited, reverse is disabled in program operation. Meanwhile, if setting F6-01 ones place=1, or the setting command of multi-function terminal is reverse, inverter will run at 0 Hz or zero torque.
- In closed-loop PID program operation mode, reverse is disabled. If there is a reverse command, inverter will run at 0Hz.

Options of acceleration /deceleration time

F6-01 tens place=0 Set as acc./dec.time 1. F0-09 sets acc. time 1, and F0-10 sets dec.time 1.

F6-01 tens place=1 Set as acc./dec.time 2. F3-15 sets acc. time 2, and F3-16 sets dec.time 2.

F6-01 tens place=2 Set as acc./dec.time 3. F3-17 sets acc. time 3, and F3-18 sets dec.time 3.

F6-01 tens place=3 Set as acc./dec.time 4. F3-19 sets acc. time 4, and F3-20 sets dec.time 4.

- See 7.1 description of acceleration/deceleration for the setting method of acc./dec.time.
- The unit acc. /dec. time is determined by F3-21, and not relative to program operation time unit.

	<p>1. Definition of acc. /dec.is relative to 0Hz, and not relative to the running direction.</p> <p>2. If inverter runs to 10Hz in preset program operation section 1 and the setting of Section 2 is to reverse to 10Hz, upon the completion of Section 1 operation, inverter will decelerate to 0Hz as per the setting deceleration time of Section 2, and then reverse and accelerate to 10Hz as per the setting acceleration time of Section 2.</p> <p>3. Upon the completion of Section 7operation, inverter will decelerate to 0Hz as per deceleration time set in Section 7.</p>
--	---

Saving options at power failure in program operation

F6-01 hundreds place=0 Not Saved

In the process of program operation, if there is a power failure or a fault of undervoltage, inverter will re-enter running status and runs from the Section 1. Cycle times will restart, and the time of previous operation sections will be cleared.

F6-01 hundreds place=1 Saved

In the process of program operation, if there is a power failure or a fault of undervoltage, inverter will save running time, operation section and cycle times, and re-enter operation

status and runs as per the program operation status at power failure.

	When selecting saving mode at power failure in program operation, please set F6-01 hundreds place only, and do not set the hundreds places of F6-02~ F6-07.
--	---

8.8.3 Setting the Operation Time of Each Operation Section

No.	Function	Range	Unit	Default	Type
F6-08	Operation Time T1	0.0~6000.0	S/min	30.0	●
F6-09	Operation Time T2	0.0~6000.0	S/min	30.0	●
F6-10	Operation Time T3	0.0~6000.0	S/min	30.0	●
F6-11	Operation Time T4	0.0~6000.0	S/min	30.0	●
F6-12	Operation Time T5	0.0~6000.0	S/min	30.0	●
F6-13	Operation Time T6	0.0~6000.0	S/min	30.0	●
F6-14	Operation Time T7	0.0~6000.0	S/min	30.0	●

F6-08~F6-14 are used to define the operation time of each operation section which can be set within 0.0~6000.0 seconds/minutes.

When the operation time is 0 second, the time will be skipped in program operation.

Remarks:

- Operation Time T=Acceleration/Deceleration time+ Steady operation time of present section. Here acceleration/deceleration time refers to the time for the speed adjusted when the operation started or at the end of last section.
- See 7.8.1 for the time unit which is defined by the ten thousands place of F6-00.

8.8.4 Skip Frequency-To Avoid Mechanical Resonation

No.	Function	Range	Unit	Default	Type
F6-16	Skip Frequency Point 1	0.00~600.00/0.0~6000.0	Hz	600.00	●
F6-17	Skip Frequency Range 1	0.00~20.00/0.0~20.0 0.00/0.0: Disabled	Hz	0.00	●
F6-18	Skip Frequency Point 2	F6-16~600.00/F6-16~6000.0	Hz	600.00	●
F6-19	Skip Frequency Range 2	0.00~20.00/0.0~20.0 0.00/0.0: Disabled	Hz	0.00	●
F6-20	Skip Frequency Point 3	F6-18~600.00/F6-18~6000.0	Hz	600.00	●
F6-21	Skip Frequency Range 3	0.00~20.00/0.0~20.0 0.00/0.0: Disabled	Hz	0.00	●

Setting jump frequency is for avoiding mechanical resonance. It is prohibited for inverter running at constant speed in skip frequency range. Inverter will run smoothly if there is no skip in acceleration or deceleration.

F6-16, F6-18, F6-20 are for setting 3 frequency skip points. Please set them as: 0.00Hz setting 3 frequency sk.

If skip point is set as 0.00, and then skip frequency is disabled. F3-17, F3-19 and F3-211 are for setting the skip frequency range of each skip point.

When setting skip frequency setting is enabled, if setting frequency is within skip frequency range, and when frequency setting rises, the output frequency will rise to = Skip frequency + Skip frequency range. When frequency setting drops, the output frequency will drop to = Skip frequency - Skip frequency range. In the process of acceleration / deceleration, the output frequency jumps across the skip frequency range smoothly as shown in Figure 7-20.

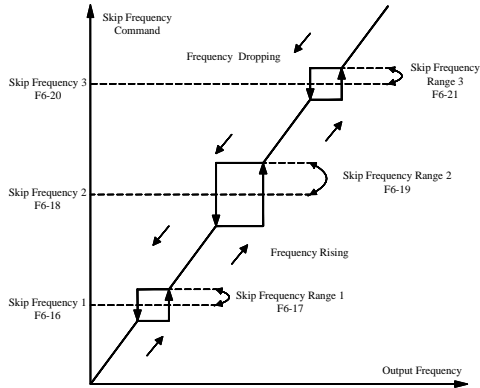

Figure 7-20 Skip Frequency

8.8.5 Wobulation

No.	Function	Range	Unit	Default	Type
F6-24	Wobulation Operation Mode	Ones place: Wobulation operation control 0: Auto-operation 1: Terminal Control Tens place: Wobulation input mode 0:Wobulation operation started after reached the mid-point 1: Start wobulation operation when its preset time is up		00	○
F6-25	Preset Frequency of Wobulation	0.00~Fmax/0.0~Fmax	Hz	0.00	●
F6-26	Preset Wobulation Time	0.00~600.00	S	15.00	●
F6-27	Upper Limit Frequency of Wobulation	Lower Limit Frequency of Wobulation~Fmax	Hz	40.00	●
F6-28	Lower Limit Frequency of Wobulation	0.00/0.0~Upper Limit Frequency of Wobulation	Hz	20.00	●
F6-29	Jump Frequency of	0.00/0.0~(Upper Limit Frequency	Hz	5.00	●

	Wobulation	of Wobulation - Lower Limit Frequency of Wobulation)/2			
F6-30	Rising Time of Wobulation	0.00~600.00	S/min	15.00	●
F6-31	Dropping Time of Wobulation	0.00~600.00	S/min	5.00	●

Wobulation is applied to the industries like textile and chemical fiber and the applications which require traversing and winding function.

Options of Wobulation Operation Control Modes

F6-24 Ones place=0 Auto-operation.

When reaching the preset frequency of wobulation (F6-25) and the preset wobulation time (F6-26) is up, inverter will automatically judge whether wobulation is needed or not (Defined by the tens place of F6-24).

F6-24 Ones place=1 Terminal Control

When reaching the preset frequency of wobulation (F6-25) and the preset wobulation time (F6-26) is up, it will be controlled by terminal when start to judge whether wobulation is needed or not (Defined by the tens place of F6-24).

Options of Wobulation Input Modes

F6-24 Tens place=0 After *START* command, inverter will run from preset frequency of wobulation (F6-25) to the mid-point of wobulation (Upper Limit Frequency of Wobulation - Lower Limit Frequency of Wobulation)/2), and then start wobulation operation.

F6-24 Tens place=1 After *START* command, wobulation operation starts directly.

Setting Preset Wobulation

F6-25 Preset frequency of wobulation

Only when running to the preset frequency of wobulation, inverter starts to judge whether wobulation is needed or not.

F6-26 Preset wobulation time

When frequency reached the preset frequency of wobulation and when preset wobulation time is up, inverter starts to judge whether wobulation is needed or not.

Frequency Limit of Wobulation Operation

F6-27 Upper limit frequency of wobulation

F6-28 Lower limit frequency of wobulation

F6-29 Jump frequency of wobulation

When operation frequency reaches the upper limit frequency or lower limit frequency, it drops or rises suddenly, and inverter will take the jump frequency of wobulation as the operation frequency base later.

Setting Wobulation Acceleration/Deceleration

F6-30 Rising time of wobulation

When operation frequency reached the lower limit frequency and after jump frequency rises, according to the rule of wobulation operation, operation frequency will accelerate to the

upper limit frequency. The rising time of wobble is the acceleration time of this process.

F6-31 Dropping time of wobble

When operation frequency reached the upper limit frequency and after jump frequency drops, according to the rule of wobble operation, operation frequency will decelerate to the lower limit frequency. The dropping time of wobble is the deceleration time of this process.

2 Wobble Operation Logic Modes:

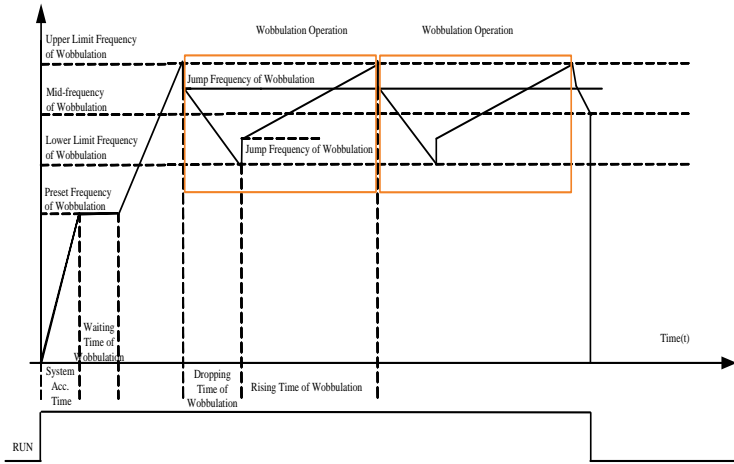

Figure 7-21

Wobble operation starts when operation frequency reached mid-frequency

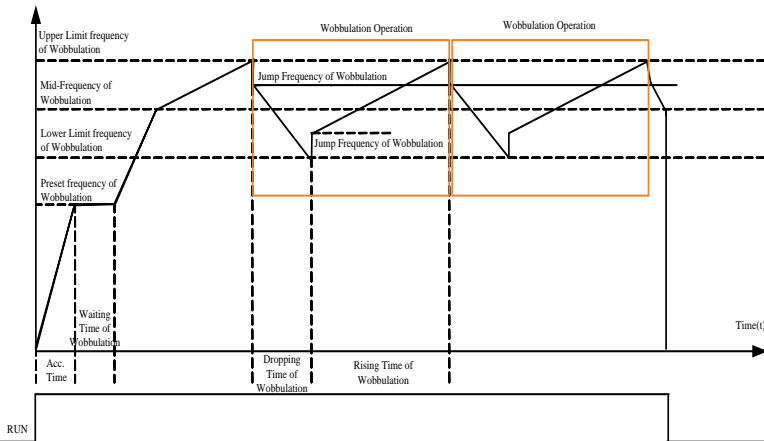

Figure 7-22

Wobble operation starts when preset time of wobble is up

8.9 F7 Group: Advanced Parameters of Operation

Overload Pre-alarms

8.9.1 Overload Pre-alarms Control

No.	Function	Range	Unit	Default	Type
F7-00	Overload Pre-Alarm Control	Ones place: Overload pre-alarm detection 0: Detect all the time 1: Detect at constant speed Tens place: inverter status after pre-alarms 0: Alarm on, run continuously 1: Delayed stop after alarm		00	○

Overload pre-alarm status is enabled that mean present current of inverter exceeds overload detection scale and the remaining time exceeds the overload detection time. User can define the detection scale and remaining time.

Overload pre-alarm detection

F7-00 ones place=0 Overload pre-alarm detection will work all the time during operation of inverter.

F7-00 ones place=1 Overload pre-alarm detection only works when the system works at constant speed.

Running mode of inverter at overload pre-alarm

F7-00 tens place=0 There is pre-alarm after reaching the overload pre-alarms scale, and inverter will run continuously.

F7-00 tens place=1 When reaching the overload pre-alarms scale, inverter will pre-alarm first and stop automatically after delayed for a while. The delay time is set by F7-03. (Please use this function with the overload pre-alarm function of multi-function output terminal in order to obtain output display before inverter stopped.)

No.	Function	Range	Unit	Default	Type
F7-01	Overload Pre-alarm Detection Time	0.00~60.00	S	5.00	○
F7-02	Overload Pre-alarm Detection Scale	0.00~600.00	%	200.00	○
F7-03	Overload Pre-alarm Stop Delay Time	0.00~600.00	S	5.00	○

F7-01 Overload pre-alarm detection time

It defines that inverter will output overload pre-alarm signal after the output current exceeds the overload pre-alarm detection scale (F7-02) continuously for certain time.

F7-02 Overload pre-alarm detection scale

It defines the current threshold of overload pre-alarms. The setting value of F7-02 is the percentage to the rated current.

F7-03 Overload pre-alarm stop delay time

If F7-00 tens place=1, its stop delay time is set by F7-03.

See Figure 7-23 overload pre-alarm control logic diagram for the description of parameters stated above.

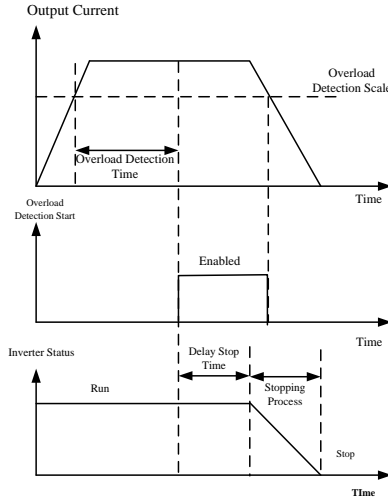

Figure 7-23 Overload Pre-alarm Control Logic

8.9.2 Analog Output Scale

No.	Function	Range	Unit	Default	Type
F7-04	Analog ADT Options	0: VS 0.00~100.00% 1: IS 0.00~100.00% 2: VF 0.00~100.00% 3: IF 0.00~100.00%		2	○
F7-05	Analog ADT1	0.00~100.00	%	20.00	●
F7-06	Analog ADT1 Hysteresis	0.00~100.00 (Monotonic decreasing is active)	%	5.00	●
F7-07	Analog ADT2	0.00~100.00	%	50.00	●
F7-08	Analog ADT2 Hysteresis	0.00~100.00 (Monotonic decreasing is active)	%	5.00	●
F7-09	Analog ADT3	0.00~100.00	%	80.00	●
F7-10	Analog ADT3 Hysteresis	0.00~100.00 (Monotonic decreasing is active)	%	5.00	●

Analog ADT function can monitor present analog value of analog input terminal and output alarming signal.

Analog ADT Options

F7-04 Analog ADT Options: Options of analog ADT input terminals

F7-05 Analog ADT1: Analog ADT input scale. Select and adjust analog ADT input scale and the input signal percentage of analog input terminal.

F7-06 Analog ADT1 Hysteresis: Options of input scale hysteresis of analog ADT1.

For instance: If F7-04=2, F7-05=25.00, F7-06=5.00, and if input voltage of analog input terminal $VF > 2.5V$ ($10V4=2$, F7-05=25.00, F7-06=5.00, and if input voltage of analog input

percentage of analog input terminal. t.ion scale (F7-02) continuously for certain time.his monotonic decreasing is active, the actual disabled point of ADT1=Analog ADT1 (F7-05)-Analog ADT1 Hysteresis(F7-06), i.e. if input voltage of analog input terminal VF=2V (10V=Analog ADT1 (og input terminal VF>2.5V (

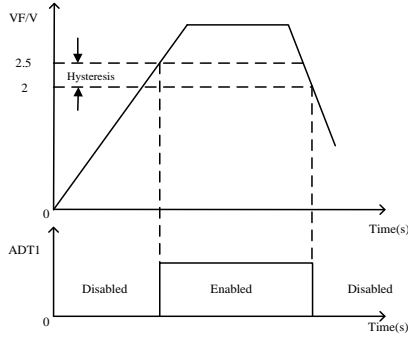

Figure 7-24 ADT Function

F7-07~F7-10 Setting method of analog ADT2 and analog ADT3 parameters is the same as that of analog ADT1.

8.9.3 Jog Analog Output

No.	Function	Range	Unit	Default	Type
F7-11	Jog M0 Output Lower Limit	0.00~100.00	%	0.00	●
F7-12	Jog M0 Output Upper Limit	0.00~100.00	%	100.00	●
F7-13	Jog M0 Output Gain	0.00~300.00	%	95.00	●
F7-14	Jog M1 Output Lower Limit	0.00~100.00	%	0.00	●
F7-15	Jog M1 Output Upper Limit	0.00~100.00	%	100.00	●
F7-16	Jog M1 Output Gain	0.00~300.00	%	95.00	●

In jog running mode, M0/M1 output can be switched as different meanings from normal running. Analog output gain and the upper and lower limit are only for M0/M1, and not related to present running status.

F7-14~F7-15 Jog output analog output upper limit and lower limit are for limiting the analog output in jog running mode.

F7-16 Jog output gain is for analog output signal proportional zooming in jog running status.

8.9.4 Carrier

No.	Function	Range	Unit	Default	Type
F7-20	Automatic PMW	0: Disabled 1: Enabled		0	●
F7-21	Lower Limit Carrier Frequency	1.000~F7-22	kHz	2.000	●
F7-22	Upper Limit Carrier Frequency	0~9kW:1.000~16.000 9kW~37kW:1.000~8.000 37kW~110kW:1.000~4.000 110kW~400kW: 1.000~3.000	kHz	6.000	●

Carrier frequency is set by F0-14. See 7.1 for the description of carrier frequency. Carrier frequency can reduce the electromagnetic noise of motor on premise of not increasing the electric loss of inverter. There are 2 automatic PMW modes for EM-series inverters which can be selected based on the motor power and mechanic devices.

Upgrading Running Performance

8.9.5 Open Loop Slip Compensation

No.	Function	Range	Unit	Default	Type
F3-30	Open Loop Slip Compensation	0.00~200.00	%	100.00	●

The speed of motor rotor decreases as load increases. In order to ensure that the speed of rotor is close to synchronous speed, motor could start slip frequency when motor is on rated load. When the speed of motor is lower than the objective value, increase the setting value of F3-30.

- F3-30=0 Slip compensation is disabled.

No.	Function	Range	Unit	Default	Type
F7-24	Slip Filter Time	0.01~20.00	S	1.00	●

F7-24 sets the filter time of slip signal if slip compensation is enabled. If the filter time is too little, it will result in system running unstably, and if the filter time is too much, it will cause compensation responding slowly.

8.9.6 Stator Voltagedrop Compensation Gain

No.	Function	Range	Unit	Default	Type
F7-25	Stator Voltagedrop Compensation Gain	0.00~200.00	%	100.00	●

F7-25 is for compensating the voltagedrop generated by stator resistance and cable.

8.9.7 Deadband Compensation Gain

No.	Function	Range	Unit	Default	Type
F7-26	Deadband Compensation Gain	0.00~200.00	%	100.00	●

Users do not need to edit F7-26 on general conditions.

8.9.8 Limit Control

No.	Function	Range	Unit	Default	Type
F7-29	MIN Effective Output Frequency	0.00~Fmax/0.0~Fmax	Hz	0.00	○
F7-30	MIN Acceleration/Deceleration Time	0.05~30.00	S/min	0.05	○

F7-29 If the setting frequency of inverter < minimum effective output frequency, inverter does not output.

F7-30 If acceleration/deceleration time < the setting value of F7-30, system will take the setting value of F7-30 as the minimum acceleration/deceleration time automatically.

8.9.9 Zero Frequency Parameter

No.	Function	Range	Unit	Default	Type
F7-31	Zero Frequency Brake Current	100.00~500.00	%	100.00	○

If F5-27=0, F7-31 is to set zero speed holding torque. The setting value of F7-31 is the percentage of idling current.

8.10 F8 Group: Input/Output Bias

8.10.1 Options of Analog Setting Signal

No.	Function	Range	Unit	Default	Type
F8-00	Voltage /Current Input Options	Ones place: VS voltage options 0: 0~10V 1: 2~10V Tens place: VF voltage options 0: 0~10V 1: 2~10V Hundreds place: IS current options 0: 4~20mA 1: 0~20mA Thousands place: IF current options 0: 4~20mA 1: 0~20mA		0000	○

Ones place: VS voltage options

F8-00 ones place=0, the linear range of terminal VS voltage input: 0~10V=0~100%. See Figure 7-25.

F8-00 ones place=1, the linear range of terminal VS voltage input: 2~10V=0~100%. See Figure 7-26.

Tens place: VF voltage options

F8-00 tens place=0, the linear range of terminal VF voltage input: 0~10V=0~100%. See Figure 7-25.

F8-00 tens place=1, the linear range of terminal VF voltage input: 2~10V=0~100%. See Figure 7-26.

Hundreds place: IS current options

F8-00 hundreds place=0, the linear range of terminal IS voltage input: 4~20mA=0~100%. See Figure 7-27.

F8-00 hundreds place=1, the linear range of terminal IS voltage input: 0~20mA=0~100%. See Figure 7-28.

Thousands place: IF current options

F8-00 thousands place=0, the linear range of terminal IS voltage input: 4~20mA=0~100%. See Figure 7-27.

F8-00 thousands place=1, the linear range of terminal IS voltage input: 0~20mA=0~100%. See Figure 7-28.

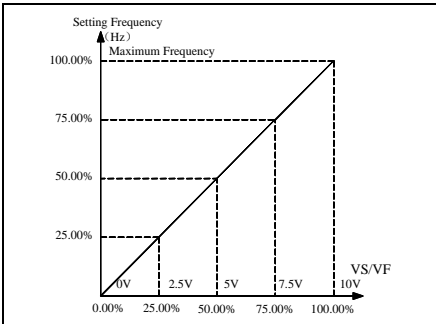

Figure 7-25 Analog Voltage Input 0~10V

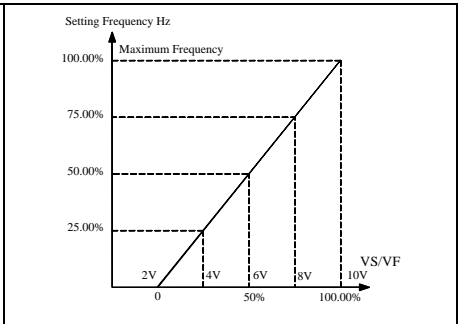

Figure 7-26 Analog Voltage Input 2~10V

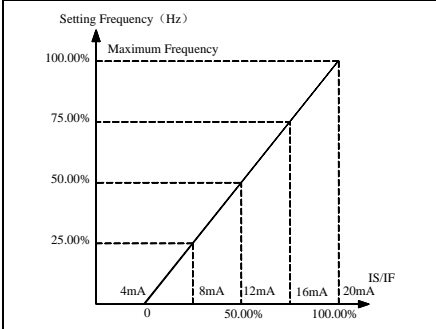

Figure 7-27 Analog Current Input 4~20mA

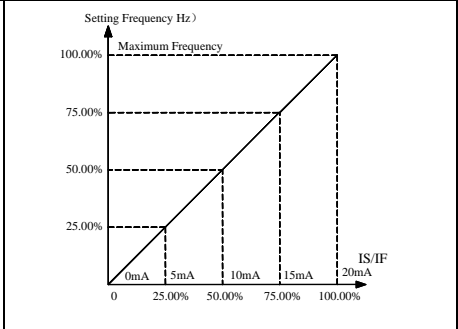

Figure 7-28 Analog Current Input 0~20mA

8.10.2 Filtering Analog Signal

No.	Function	Range	Unit	Default	Type
F8-03	VP Filter Time	0.00~60.00	S	0.10	●
F8-04	VS Filter Time	0.00~60.00	S	0.10	●
F8-05	IS Filter Time	0.00~60.00	S	0.10	●
F8-06	VF Filter Time	0.00~60.00	S	0.10	●
F8-07	IF Filter Time	0.00~60.00	S	0.10	●

Filter the analog signal to clear signal interference. If the filtering time is too long, the response speed of analog signal will be lowered.

F8-03~F8-07 set filter times of 5 analog signals. Users do not need to adjust these parameters on general conditions.

8.10.3 Options of Analog Setting Signal Bias Curve

No.	Function	Range	Unit	Default	Type
F8-01	Voltage/Current Bias Options	Ones place: VS voltage bias options 0: Input / output bias 0 1: Input / output bias 1 2: Input / output bias 2		2210	○

		Tens place: VF voltage bias options 0: Input / output bias 0 1: Input / output bias 1 2: Input / output bias 2 Hundreds place: IS current bias options 0: Input / output bias 0 1: Input / output bias 1 2: Input / output bias 2 Thousands place: IF current bias options 0: Input / output bias 0 1: Input / output bias 1 2: Input / output bias 2			
F8-02	VP Bias Options	0: Input / output bias 0 1: Input / output bias 1 2: Input / output bias 2		2	○

On special occasions, user can set a bias curve of analog signal.

Ones place: VS voltage bias options

F8-01 ones place=0/1/2 corresponding to input / output bias 0/1/2

Tens place: VF voltage bias options

F8-01 tens place=0/1/2 corresponding to input / output bias 0/1/2

Hundreds place: IS current bias options

F8-01 hundreds place=0/1/2 corresponding to input / output bias 0/1/2

Thousands place: IF current bias options

F8-01 thousands place=0/1/2 corresponding to input / output bias 0/1/2

VP Bias Options

F8-02 ones place=0/1/2 corresponding to input / output bias 0/1/2

8.10.4 Setting Bias Curve of Analog Setting Signal

No.	Function	Range	Unit	Default	Type
F8-08	Output Bias 0_0	0.00~100.00	%	0.00	●
F8-09	Output Bias 0_1	0.00~100.00	%	25.00	●
F8-10	Output Bias 0_2	0.00~100.00	%	75.00	●
F8-11	Output Bias 0_3	0.00~100.00, 100.00=Fmax	%	100.00	●
F8-12	Input Bias 0_0	0.00~ Input Bias 0_1	%	0.00	●
F8-13	Input Bias 0_1	Input Bias 0_0~ Input Bias 0_2	%	25.00	●
F8-14	Input Bias 0_2	Input Bias 0_1~ Input Bias 0_3	%	75.00	●
F8-15	Input Bias 0_3	Input Bias 0_2~100.00	%	100.00	●

F8-08~F8-15 set input/output bias 0.

F8-08, F8-09, F8-10, and F8-11 set the output bias of 4 points of user defined bias curve. They can be set continuously in the range of 0.0% ~ 100.0%.

F8-12, F8-13, F8-14, and F8-15 set the analog inputs of 4 points of user defined bias curve.

The analog input can be set continuously in the full scale input range of 0.0~100.0% as
Oinput can be set continuously in

For instance:

1. See Table 7-6 for setting parameter

Table 7-6

No.	Setting Value	No.	Setting Value
F8-08	0.00%	F8-12	0.00%
F8-09	30.00%	F8-13	25.00%
F8-10	65.00%	F8-14	75.00%
F8-11	100.00%	F8-15	100.00%

If analog input is VS/VF (0~10V) or IS/IF (0~20mA), see Figure 7-29(a) for the input/output bias.

If analog input is VS/VF (2~10V) or IS/IF (4~20mA), see Figure 7-29(b) for the input/output bias.

2. See Table 7-7 for setting parameter

Table 7-7

No.	Setting Value	No.	Setting Value
F8-08	100.00%	F8-12	0.00%
F8-09	70.00%	F8-13	40.00%
F8-10	40.00%	F8-14	75.00%
F8-11	0.00%	F8-15	100.00%

If analog input is VS/VF (0~10V) or IS/IF (0~20mA), see Figure 7-29(C) for the input/output bias.

If analog input is VS/VF (2~10V) or IS/IF (4~20mA), see Figure 7-29(d) for the input/output bias.

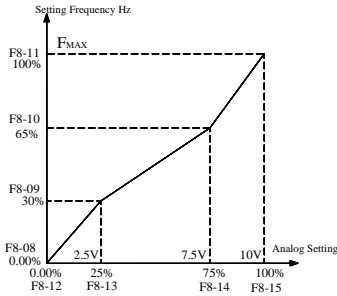

(a)

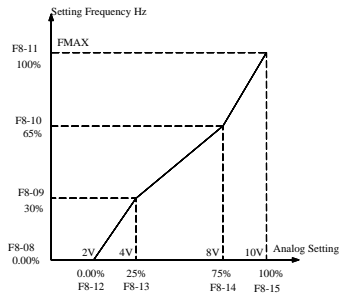

(b)

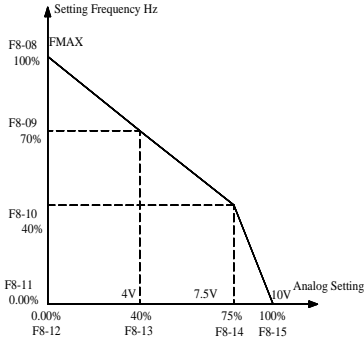

(c)

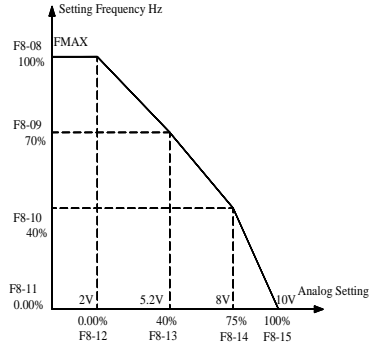

(d)

Figure7-29 Input/Output Bias

- F8-16~F8-23 set input/output bias 1, the setting method is the same as that of setting input/output 0.
- F8-24~F8-31 set input/output bias 2, the setting method is the same as that of setting input/output 0.

8.11 F9 Group: Speed Setting Options

Data Input

8.11.1 Parameter Editing Mode

No.	Function	Range	Unit	Default	Type
F9-01	Parameter Editing Mode	0:Editable through keypad and RS485		0	○
		1:Editable through keypad			

F9-01=0 Inverter parameters can be set via keypad or RS485 communication

F9-01=1 Inverter parameters can be edited and set via keypad.

8.11.2 Data Input Control Mode

No.	Function	Range	Unit	Default	Type
F9-02	Numeric Input Control Mode	Ones place: Numeric reference input control mode 0: Auto-save the change in RAM (Press <input type="button" value="DATA ENTER"/> to save) 1: Auto-save the change in EEPROM (Memory function at power failure) Tens place: Not used Hundreds place: Not used Thousands place: Terminal UP/DOWN rate control 0: Automatic rate control 1: Correspond to the setting UP/DOWN rate Ten thousands place: Not Used		1000	○
F9-07	UP/DOWN Frequency Rate	0.00~100.00/0.0~100.0	Hz/S	1.00	●

F9-02 ones place=0 After numeric reference input changed, it can only be saved by pressing



F9-02 ones place=1 After the setting value of primary numeric frequency (F0-07) changed, it will be saved automatically without pressing



F9-02 thousands place=0 Edit the numeric reference input slowly at first, and then fast later based on the effective lasting time of terminal UP/DOWN.

F9-02 thousands place=1 Edit the numeric reference input as per the setting UP/DOWN rate set by F9-07 based on the effective lasting time of terminal UP/DOWN, it will be calculated by second, and only round-up no round-off.

F9-07 UP/DOWN frequency rate: Set the acceleration/deceleration rate of terminal UP/DOWN frequency.

Remarks:

- UP/DOWN function is only applied in stepping mode.
- UP/DOWN frequency rate of keypad is a fixed rate. It is only for F0-07.

Speed Setting

8.11.3 Speed Setting Mode

No.	Function	Range	Unit	Default	Type
F9-03	Speed Setting Mode	Ones place: Integrated speed input mode 0: Primary speed setting mode 1: Auxiliary speed setting mode 2: Primary speed setting + auxiliary speed setting Tens place: Speed setting mode under jog control 0: Jog numeric speed setting mode 1: Jog numeric speed setting mode + primary speed setting mode 2: Jog numeric speed setting mode + auxiliary speed setting mode Hundreds place: Relation between auxiliary speed and primary speed 0: Primary speed + auxiliary speed 1: Primary speed - auxiliary speed		000	○

F9-03 ones place is for selecting integrated speed input mode.

F9-03 ones place =0 The integrated speed is only set by primary speed setting mode, and auxiliary speed setting mode is disabled.

F9-03 ones place =1 The integrated speed is only set by auxiliary speed setting mode, and primary speed setting mode is disabled.

F9-03 ones place =2 Select integrated speed input mode =the auxiliary speed setting (Please pay attention to that the value is positive or negative) + primary speed setting.

If auxiliary speed + primary speed > the upper limit frequency, inverter will output as per the upper limit frequency.

- F9-03 ones place =1/2 can be switched to the status of F9-03 tens place =0 through multi-function terminal.

F9-03 tens place is for speed setting mode when jog control mode is enabled.

F9-03 tens place=0 If jog command is enabled, speed setting value=F0-11 Jog numeric frequency.

F9-03 tens place=1 If jog command is enabled, speed setting value=F0-11 Jog numeric frequency+ Primary speed setting.

F9-03 tens place=2 If jog command is enabled, speed setting value=F0-11 Jog numeric frequency+ auxiliary speed setting (Please pay attention to that the value is positive or negative).

- F9-03 tens place=1/2 can be switched to the status of F9-03 hundreds place =0 through multi-function terminal.

F9-03 hundreds place is for selecting the relation between auxiliary speed and primary speed.

F9-03 hundreds place=0 Primary speed + auxiliary speed

F9-03 hundreds place=1 Primary speed - auxiliary speed



1. Please confirm the integrated speed setting mode first, and then confirm the primary speed setting mode and the setting method in jog control mode.
2. Primary speed setting + auxiliary speed setting can be considered as converting those 2 signals into 0~10V voltage signal, and then take the sum of them as the integrated speed setting. If the sum>10V, it will be considered as 10V.
3. Numeric setting + analog setting can be considered as converting the analog setting into the corresponding setting frequency, and then add numeric setting frequency. Please note that if the sum is greater than the upper limit frequency, inverter will output as per the upper limit frequency.

8.11.4 Special Speed Setting Mode

No.	Function	Range	Unit	Default	Type
F9-04	Special Speed Setting Mode	0: Program Operation 1: Wobulation Mode 2: Stepping Mode 0 3: Stepping Mode 1 4: Stepping Mode 2 5: Stepping Mode 3 6: Stepping Mode 4 7: Stepping Mode 5		0	○

F9-04=0 Program Operation

If F0-26 is selected as special speed setting mode, inverter will run in program setting mode. See 7.8 for program running setting.

F9-04=1 Wobulation Mode

If F0-26 is selected as special speed setting mode, inverter will run in wobulation mode. See 7.8 for wobulation running mode.

F9-04=2 Stepping Mode 0

The starting frequency is F0-07 primary numeric frequency setting. When terminal UP/DOWN is on, the starting frequency will rise/drop as per the present effective acceleration/deceleration time. When terminal UP/DOWN is off, the starting frequency will remain present output frequency unchanged. In stopping state, the setting frequency is changed as F0-07.

F9-04=3 Stepping Mode 1

Starting frequency is 0Hz. When terminal UP/DOWN is on, the starting frequency will rise/drop as per the present effective acceleration/deceleration time. When terminal UP/DOWN is off, the starting frequency will remain present output frequency unchanged.

F9-04=4 Stepping Mode 2

Starting frequency is F0-07 primary numeric frequency setting. When terminal UP/DOWN is on, the starting frequency will rise/drop as per F9-07 UP/DOWN frequency rate. When terminal UP/DOWN is off, the starting frequency will remain present output frequency unchanged. In stopping state, the setting frequency is changed as F0-07.

F9-04=5 Stepping Mode 3

Starting frequency is 0Hz. When terminal UP/DOWN is on, the starting frequency will rise/drop as per F9-07 UP/DOWN frequency rate. When terminal UP/DOWN is off, the starting frequency will remain present output frequency unchanged.

F9-04=6 Stepping Mode 4

Starting frequency is F0-07 primary numeric frequency setting. When terminal UP/DOWN is on, the starting frequency will rise/drop as per F9-07 UP/DOWN frequency rate. When terminal UP/DOWN is off, the setting frequency will reset as F0-07 primary numeric frequency setting.

F9-04=7 Stepping Mode 5

The starting frequency is primary numeric frequency setting of F0-07, when UP/DOWN terminal is ON, the starting frequency rises/falls as per UP/DOWN frequency ratio of F9-07; when UP/DOWN terminal is off, the setting frequency follows the real time output frequency without change.



1. Terminal UP/DOWN is set by multi-function terminal program. For instance: if set F2-03=13, and F2-04=14, the X4 is terminal UP, and X5 is terminal DOWN.
2. Present effective acceleration/deceleration time can be defined by the status of acceleration/deceleration time terminals set by F2-00~F2-06. If acceleration/deceleration time terminals are OFF, the present effective acceleration/deceleration time will be defined by F9-05 and F0-10.

8.11.5 Auxiliary Speed Setting Mode

No.	Function	Range	Unit	Default	Type
F9-05	Auxiliary Speed Setting Mode	0: Auxiliary numeric frequency 1: VP 2: VS 3: IS 4: Not Used 5: $K3*VS+K4*IS$ 6: $K3*VS+K5*VF$ 7: $K4*IS+K6*IF$ 8: $\text{MAX}\{K3*VS, K5*VF\}$ 9: $\text{MAX}\{K4*IS, K6*IF\}$ 10: $K1*VP+K2*(K3*VS+K4*IS+K5*VF+K6*IF-K8*5V)$		0	○
F9-06	Auxiliary Numeric Frequency Setting	0.00~Fmax/0.0~Fmax	Hz	0.00	●

F9-05=0 Defined by the value of F9-06.

F9-05=1 Set by VP keypad potentiometer.

F9-05=2 Set by the voltage of analog terminal VS.

F9-05=3 Set by the current of analog terminal IS.

F9-05=5 Set by $K3*VS+K4*IS$ (Input signals VS and IS)

F9-05=6 Setting frequency is set by $K3*VS+K5*VF$ (Input voltage signals VS and VF)

F9-05=7 Setting frequency is set by: $K4*IS+K6*IF$ (Input current signals IS and IF)

F9-05=8 Setting frequency is set by the greater value between $K3*VS$ and $K5*VF$ (Inputs of 2 terminals)

F9-05=9 Setting frequency is set by the greater value between $K4*IS$ and $K6*IF$ (Inputs of 2 terminals)

F9-05=10 Setting frequency is set by:

$K1*VP+K2*(K3*VS+K4*IS+K5*VF+K6*IF-K8*5V)$ (All input signals)

8.11.6 Multi-function Output Related to Frequency Detection

No.	Function	Range	Unit	Default	Type
F9-09	Frequency of Zero Speed Detection	0.00~50.00/0.0~50.0	Hz	0.00	○

If multi-function output or relay output=20 (Frequency of zero speed detection), and when inverter is running, if the output frequency < the setting value of F9-09, it will be considered as inverter runs at zero speed, and the corresponding output terminal will be on.

No.	Function	Range	Unit	Default	Type
F9-10	Zero Speed Detection Output Delay	0.00~600.00	S	1.00	○

F9-10 is to delay the action of output terminal corresponding to zero speed detection when zero speed detection is enabled.

8.11.7 Output Frequency Range

No.	Function	Range	Unit	Default	Type
F9-11	Frequency Reach Signal FAR	0.00~50.00/0.0~50.0	Hz	2.50	○

If multi-function output or relay output=1(Frequency Reach Range FAR), and if | the output frequency of inverter- input setting frequency | <the setting value of F9-11, the corresponding output terminal will be on. See Figure 7-30 for details.

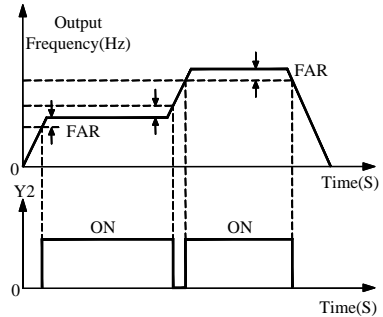

Figure 7-30 Frequency Reach Range FAR

8.11.8 Output Frequency Detection Range FDT

No.	Function	Range	Unit	Default	Type
F9-12	FDT1 Increasing Threshold	0.00~Fmax /0.0~Fmax	Hz	30.00	○
F9-13	FDT1 Decreasing Threshold	0.00~Fmax /0.0~Fmax	Hz	30.00	○
F9-14	FDT2 Increasing Threshold	0.00~Fmax /0.0~Fmax	Hz	30.00	○
F9-15	FDT2 Decreasing Threshold	0.00~Fmax /0.0~Fmax	Hz	30.00	○

If multi-function output or relay output=2(Output Frequency Detection Range FDT1), and if the output frequency of inverter rises to the setting value of FDT1 increasing threshold (F9-12), the corresponding terminal will be on. If the output frequency of inverter drops and the output frequency < the setting value of FDT1 decreasing threshold (F9-13), the corresponding terminal will be off. See Figure 7-31-a and Figure 7-31-b.

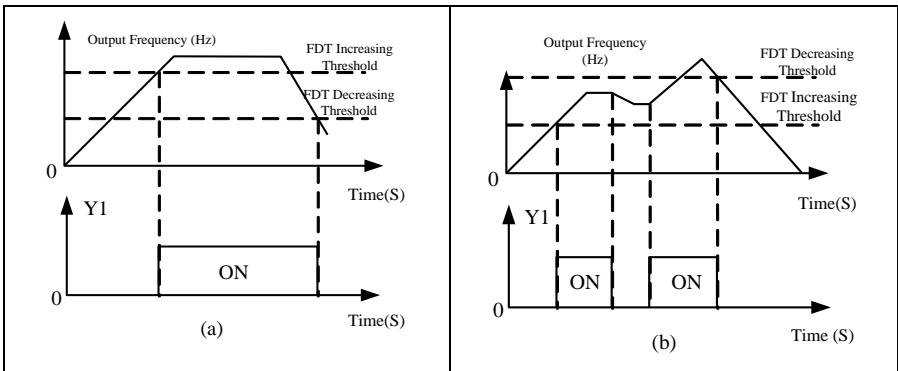

Figure 7-31 Output Frequency Detection Range FDT

Power Failure Control at Power-on

8.11.9 Non-Stop Control at Instantaneous Power Failure

No.	Function	Range	Unit	Default	Type
F9-17	Non-Stop Control Options at Instantaneous Power Failure	0: Disabled 1: Enabled		0	○
F9-20	Control Voltage of Non-Stop at Instantaneous Power Failure	0~800	V	537	●
F9-21	Proportion Gain of Non-Stop at Instantaneous Power Failure	0.00~300.00		0.50	●
F9-22	Integral Time of Non-Stop at Instantaneous Power Failure	0.00~600.00	S	1.50	●
F9-23	Base Time of Non-Stop at Instantaneous Power Failure	0.00~600.00	S	2.00	●

Non-stop function at instantaneous power failure is only applied to the occasions when a sudden grid power failure occurs but power resumes soon later.

F9-17=0: Disabled. If there was an instantaneous power failure in running, inverter trips fault and enters fault status, and motor is ramp-to-stop.

F9-17=1: Enabled. If there was an instantaneous power failure in running, inverter will remain DC bus voltage to keep motor running continuously by calculating ramp-to-stop time automatically based on load. When power resumed in ramp-to-stop, inverter runs normally.

F9-20: The DC bus voltage of non-stop at instantaneous power failure is taken the setting value of F9-20 as the target value for adjusting deceleration time.

F9-21 ~ F9-23 are for calculating and adjusting the deceleration time of non-stop at instantaneous power failure. PI regulation is adopted to ensure that inverter can run with proper DC bus voltage. Users can adjust PI parameters based on load.

8.11.10 Start Delay Time After Power-on

No.	Function	Range	Unit	Default	Type
F9-24	Start Delay Time After Power-on	0.00 ~ 10.00 (The time for inverter to wait for the initial operation after power-on)	S	1.00	●

F9-24 sets the waiting time of system initialization when inverter is power-on. If inverter is required to run immediately after power-on, it can be set as 0.

8.11.11 Command Control

No.	Function	Range	Unit	Default	Type
F9-25	Terminal Operation Command Control	0: Terminal shall be off first, and then on. 1: Inverter will run directly		1	○

F9-25=0 Terminal shall be off first, and then on.

If the start/stop control mode is in 2-wire sequence and the terminal is ready, when PLC

monocycle running time is up, pressing , external terminal stop, coast-to-stop command, and fault, the terminal shall be off first and on again later, and then the inverter can be started.

F9-25=1 Inverter will run directly.

If the start/stop control mode is in 2-wire sequence and the terminal is ready, inverter will run directly. (Do not need to confirm the status of F9-25, inverter can be started directly.)

8.11.12 Auxiliary Function

No.	Function	Range	Unit	Default	Type
F9-16	Cut-off Frequency of Oscillation Suppression	20~400	%	90	○
F9-27	Oscillation Suppression Gain	0~20000		300	●

F9-27 sets function of oscillation suppression gain. It enables motor to lower the oscillation degree when oscillation happens. (Enabled in open-loop V/F mode)

Speed Search

8.11.13 Speed Search

No.	Function	Range	Unit	Default	Type
F9-28	Speed Search Mode of Software	0: Maximum frequency 1: Stop frequency 2: Setting frequency		0	○

F9-28=0 Maximum frequency

When inverter starts speed search, it will start from the maximum frequency.

F9-28=1 Stop frequency

When inverter starts speed search, it will start from the frequency when inverter stops.

F9-28=2 Setting frequency

When inverter starts speed search, it will start from 50Hz.

No.	Function	Range	Unit	Default	Type
F9-26	Voltage Resume Time of Speed Search	0.00~5.00	S	0.30	●

When F9-28=2, inverter will start speed search from the setting frequency of F9-26

No.	Function	Range	Unit	Default	Type
F9-18	Speed Search Current	0.30~1.50		0.60	○

Speed search current is the ratio relative to the inverter rated current. The smaller the current is, the smaller impact to the motor is, and the accuracy of speed search is high. But if the setting value is too small, it may cause inaccurate speed search result and start failure. The larger the current is, the motor speed will not drop too much. Please increase the setting value of F9-18 when speed search on heavy load.

No.	Function	Range	Unit	Default	Type
F9-19	Speed Search Coefficient	1.00~1.30		1.05	○

Generally, speed search coefficient can take default. When searching speed is too fast and overvoltage fault occurs, please try to increase the setting value of F9-19.

Undervoltage Detection

8.11.14 Undervoltage Detection Scale

No.	Function	Range	Unit	Default	Type
F9-30	Undervoltage Detection Scale	0.00~100.00 (Udc_e)	%	65.18	○

When the DC bus of inverter<undervoltage detection scale, system will trip undervoltage. The fault of undervoltage: $537\text{VDC} \times 65.18\% = 350\text{VDC}$

No.	Function	Range	Unit	Default	Type
F9-31	Undervoltage Detection Time	0.00~30.00	S	0.50	○

When the DC bus of inverter remains lower than undervoltage detection scale (F9-30), and when it exceeds the undervoltage detection time, inverter will trip undervoltage fault to avoid false trip cause by interference.

8.12 FA Group: Advanced Parameters of Vector Control

8.12.1 Torque Input

No.	Function	Range	Unit	Default	Type
FA-06	Regular Torque Options	0: Regular torque input 1: VS* Regular torque input 2: VF* Regular torque input 3: IS* Regular torque input 4: IF* Regular torque input		0	○

FA-06 When torque setting mode is regular torque input, FA-06 is defined by setting of F5-11. FA-06 is for selecting corresponding torque input mode.

8.12.2 Preset Current Limit

No.	Function	Range	Unit	Default	Type
FA-07	Preset Current Limit 1	0.00~180.00	%	150.00	○
FA-08	Preset Current Limit 2	0.00~180.00	%	150.00	○
FA-09	Preset Current Limit 3	0.00~180.00	%	150.00	○
FA-10	Preset Current Limit 4	0.00~180.00	%	150.00	○
FA-11	Preset Current Limit 5	0.00~180.00	%	150.00	○
FA-12	Preset Current Limit 6	0.00~180.00	%	150.00	○
FA-13	Preset Current Limit 7	0.00~180.00	%	150.00	○

FA-07~FA-13 When current stall control is enabled (FC-07=2), these parameters set the current limit scale of each preset torque current in program running. The setting of control terminal corresponding to preset current limit refers to 7.3 for setting the function of multi-function input terminal as preset current limit function.

Preset current limit is enabled, 3 input terminals can be defined as the preset current limit terminals. A preset current limit set in FA-07~FA-13 is selected correspondingly through programming these 3 terminals.

Motor 2 Parameter Setting

8.12.3 Basic Parameters of Motor 2

No.	Function	Range	Unit	Default	Type
FA-14	Motor 2 Rated Power	0.40~480.00	kW	XXXX	○
FA-15	Motor 2 Rated Voltage	60~660	V	XXX	○
FA-16	Motor 2 Rated Current	0.1~1500.0	A	XXXX	○
FA-17	Motor 2 Rated Frequency	20.00~600.00/20.0~6000.0	Hz	XXXX	○
FA-18	Motor 2 Rated Speed	1~60000	rpm	XXXX	○
FA-19	Motor 2 Wiring Mode	0: Y, 1: Δ		X	○
FA-20	Motor 2 Rated Power Factor	0.50~0.99		X	○

When inverter is connected to Motor 2 at the first time, please set all parameters corresponding to the nameplate of Motor 2.

8.12.4 Motor 2 Running Parameters

No.	Function	Range	Unit	Default	Type
FA-21	Motor 2 Idling Excitation Current I0	0.1~1500.0	A	XXXX	○
FA-22	Motor 2 Rated Torque Current	0.1~1500.0	A	XXXX	×
FA-23	Motor 2 Stator Resistance R1	0.01~60.000	Ω	XXXX	○
FA-24	Motor 2 Rotator Resistance R2	0.01~60.000	Ω	XXXX	○
FA-25	Motor 2 Stator& Rotor Leakage Inductance Ls	0.1~3000.0	mH	XXXX	○
FA-26	Motor 2 Stator& Rotor Mutual Inductance Lm	0.1~3000.0	mH	XXXX	○
FA-27	Motor 2 Efficiency	30.0~99.0	%	XXXX	○

FA-21~FA-27 are motor parameters. Users cannot know these parameters on general conditions, please obtain the parameters by motor parameter autotuning. Before motor parameter autotuning, inverter will set the motor nameplate parameters, which are set by FA-14~FA-20, as the standard motor parameters automatically.

8.13 FC Group: Parameters of Operation Control

8.13.1 Acceleration/Deceleration Mode Control

No.	Function	Range	Unit	Default	Type
FC-00	Acceleration/Deceleration Mode	0: Linear mode 1: S curve mode		0	○
FC-01	Proportion of Acceleration S Curve	0.0~50.0	%	30.0	○
FC-02	Proportion of Deceleration S Curve	0.0~50.0	%	30.0	○

FC-00=0 Linear mode acceleration/deceleration

Output frequency increases/decreases progressively in linear mode. Acceleration/Deceleration time is set by F0-09 and F0-10.

FC-00=1 S curve mode acceleration/deceleration

Output frequency increases/decreases progressively as per curve. Generally S curve is used for the applications which require smooth start and stop like elevator and conveyor. As shown in Figure 7-23, in the process of acceleration, t1 = the setting value of FC-01* Acceleration time, t2= the setting value of FC-02* Acceleration time. In the process of

deceleration, t_1 = the setting value of FC-01* Deceleration time, t_2 = the setting value of FC-02* Deceleration time.

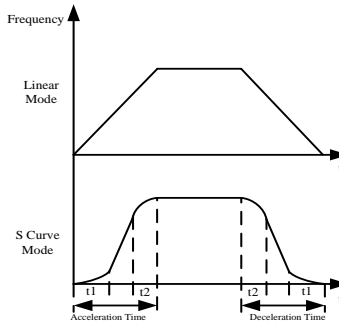

Figure 7-23 Acceleration/Deceleration Control

8.13.2 Fan Control

No.	Function	Range	Unit	Default	Type
FC-03	Fan Control	0: Run at power-on 1: Run at start-up		1	○
FC-04	Fan Delay Time	0.00~600.00	S	30.00	●

FC-03 selects the conditions for fan to run.

FC-03=0 Fan runs at power-on.

FC-03=1 Fan runs while inverter is running.

FC-04 selects the delay time for fan turned-on. In default status, the fan will stop after the inverter is stopped for 30 seconds.

8.13.3 Reset Previous Working Status

No.	Function	Range	Unit	Default	Type
FC-06	Reset previous working status at power-on	0: Not Reset 1: Reset		0	○

FC-06=0 Inverter will not reset previous working status.

FC-06=1 Inverter remains the previous work status before power failure after it was powered-on.

8.13.4 Current Control and Energy Saving

No.	Function	Range	Unit	Default	Type
FC-07	Current Stall Control	0: Disabled 1: Not Used 2: Enabled		2	○
FC-08	Overcurrent Stall Current	50.00~180.00	%	150.00	○
FC-09	Current Limit Coefficient of Weak Flux	0.20~1.00		0.70	○

FC-21	Overcurrent Stall Proportion Gain IKp	0.00~100.00		0.10	○
FC-31	Integral Time of Overcurrent Stall	0.00~300.00	mS	20.00	○

Current limit control

FC-07 =0 Disabled

FC-07 =1 Not used

FC-07 =2 Enabled

In the process of operation, when the current of motor which is on load reaches overcurrent stall current (Set by FC-08), if overcurrent stall protection mode is enabled, system will start overcurrent stall protection , it will lower output frequency for limiting the rising output current, enable inverter runs at overcurrent stall status. When output current drops and is less than overcurrent stall current, inverter return previous running status. See Figure 7-33 for overcurrent stall enabling process.

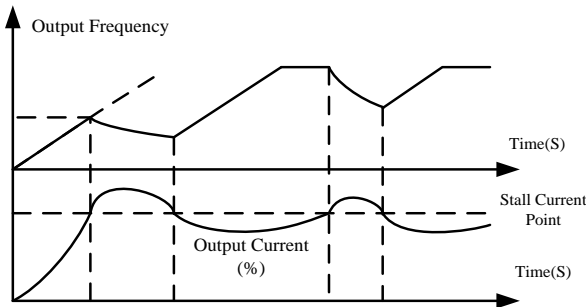



Figure 7-33 Overcurrent Stall Enabling Process

 Overcurrent stall is only enabled in V/F control mode. It is recommended for the applications with big inertia, fans, or multi-motor driven by single-inverter.

8.13.5 Overcurrent Stall Current

FC-08 is for setting overcurrent stall current. If the output current of inverter > the setting value of FC-08, the overcurrent stall control is enabled for controlling the output current < the setting value of FC-08.

- FC-08 refers to the ratio of output current to the rated output current of inverter.
- Users can set overcurrent stall current to protect motor or to meet application requirements.

8.13.6 Current Limit Coefficient of Weak Flux

FC-09 is applied to limit inverter’s output current when the motor is operating in flux weakening, to ensure the best output power when the motor accelerates or decelerates in flux weakening.

8.13.7 Overcurrent Stall Parameters

FC-21 and FC-31 are the auto-regulation parameters of internal overvoltage protection. They are used for after-sales regulation. The defaults can meet most of application needs.

8.13.8 Energy Saving Operation

No.	Function	Range	Unit	Default	Type
FC-10	Energy Saving Operation Options	0: Energy saving operation disabled 1: Energy saving operation enabled		0	<input type="radio"/>
FC-11	Energy Saving Running Initial Frequency	10.00~600.00/10.0~600.0	Hz	20.00	<input type="radio"/>
FC-12	Energy Current Detecting Range	20.00~80.00	%	40.00	<input type="radio"/>
FC-13	Energy Saving Delay Start Time	0.01~60.00	S	0.50	<input type="radio"/>
FC-14	Permitted Energy Saving Range	60.00~100.00	%	80.00	<input type="radio"/>

FC-10=1, energy saving operation control is enabled. When inverter runs in idling or on light load (output current of inverter < the setting value of FC-12), if the output frequency > energy saving starting frequency (Set by FC-11), inverter will test load current automatically and make a record of time. If the setting time of FC-13 can meet energy saving needs, the output voltage shall be dropped to energy saving permitted range (Set by FC-14) to start energy saving operation. When output frequency < the starting frequency of energy saving or load is increasing, inverter will withdraw from energy saving operation status. Output voltage will reset corresponding value.

If output current of inverter > the setting value of FC-12, automatic energy saving is disabled. See Figure 7-34 for operation process of automatic energy saving.

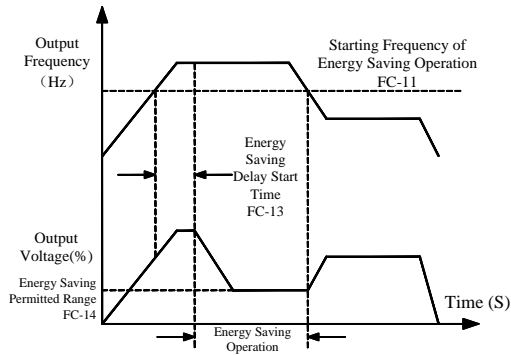

See Figure 7-34 Operation Process of Automatic Energy Saving

 In V/F control mode, the percentage of output voltage is the energy saving permitted range.

8.13.9 Output Voltage Control

No.	Function	Range	Unit	Default	Type
FC-15	Output Voltage	0.00~100.00	%	100.00	●

8.13.10 Adjusting Output Voltage

To set parameters of FC-15 is to adjust the output voltage of inverter.

If input voltage is 380VAC, and if FC-15 is set as 58.00, it refers that the motor (220V Input) can be applied. The rated current of motor (220V input) shall not be bigger than the rated output current of inverter.

Remarks:

The function is disabled in SVC mode.

8.13.11 Brake Duty Ratio

No.	Function	Range	Unit	Default	Type
FC-16	Brake Duty Ratio	5.00~100.00	%	80.00	○

Braking unit works in PWM mode at dynamic braking. FC-16 is for setting the duty ratio of braking unit. The bigger the setting value of FC-16 is, the stronger the brake capability is. When setting brake duty ratio, please take the resistance and capacity of braking resistor. The function is only for the built-in braking unit.

8.13.12 Over-modulation Coefficient

No.	Function	Range	Unit	Default	Type
FC-17	Over-modulation Coefficient	1.00~1.10		1.05	●

If input voltage of inverter < output voltage, the utility of DC bus will be improved by increasing over-modulation coefficient so that the upper limit of output voltage will be increased. When FC-17=1.10, it refers to that the upper limit of output voltage will be 10% higher.

8.13.13 Voltage Control

No.	Function	Range	Unit	Default	Type
FC-18	Voltage Control	Ones place: AVR control 0: Disabled 1: Enabled 2: Auto-AVR Tens place: AVR limit control 0: Limit disabled 1: Limit enabled Hundreds place: Not used		001	○

FC-18 ones place=0 AVR disabled

Output voltage varies with the changes of input voltage or DC bus voltage.

FC-18 ones place=1 AVR enabled (Enabled all the time)

If input voltage < rated input voltage of inverter, and output frequency > corresponding frequency to the voltage on V/F curve, inverter will output maximum voltage to make motor work at maximum capacity. If input voltage > rated input voltage of inverter, inverter will drop the output voltage and remains V/F proportion.

FC-18 ones place=2 AVR enabled automatically

Inverter will adjust output voltage automatically based on the changes of load and grid power. It ensures that motor runs in constant torque at low speed or in constant capacity at high speed, and makes motor run at optimized status.

FC-18 tens place=0 AVR limit disabled

AVR base fixed as 100%.

FC-18 tens place=1 AVR limit enabled

Inverter selects internal AVR base automatically.

8.13.14 Overvoltage Protection Control

No.	Function	Range	Unit	Default	Type
FC-19	Overvoltage Protection Control	Ones place: Not Used Tens Place: Dynamic brake options 0: Braking resistor disabled 1: Braking resistor is enabled in operation 2: Braking resistor is enabled at power-on Hundreds place: Not Used Thousands place: Voltage stall protection mode 0.Void 1.Under voltage stall effective 2.Over voltage stall effective 3.Both under voltage stall and over voltage stall effective		2000	○

Generally DC bus overvoltage is caused by deceleration. Due to energy feedback, DC bus voltage will rise at deceleration. When DC bus voltage > overvoltage threshold:

- If dynamic brake is enabled, built-in braking unit is switched on. External resistor will consume part of feedback energy. Until DC bus voltage < lower limit of overvoltage stall voltage, inverter will switch off braking unit automatically.
- If overvoltage stall protection is enabled, inverter will stop deceleration temporarily and remains output frequency unchanged, and then energy feedback stops. Until DC bus voltage drops and be lower than lower limit of overvoltage stall voltage, deceleration will start again. See Figure 7-35 for overvoltage stall protection at deceleration.
- The above 2 protections are enabled in all driven modes.

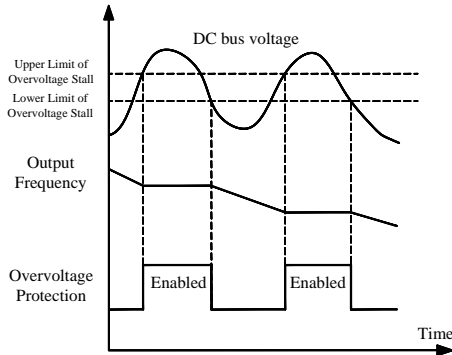

Figure 7-35 Overvoltage Stall Protection

FC-19 tens place=0 Dynamic brake disabled

Regardless how big the DC bus is, braking input power will not work.

FC-19 tens place=1 Dynamic brake enabled when inverter is running.

When inverter is running, DC bus voltage > overvoltage threshold, braking unit discharge starts. When DC bus voltage drops, and DC bus voltage < overvoltage threshold, braking unit shall be turned off immediately.

FC-19 tens place=2 Dynamic brake enabled when inverter is power-on.

If DC bus voltage > overvoltage threshold, braking unit discharge starts. When DC bus voltage drops, and DC bus voltage < overvoltage threshold, braking unit shall be turned off.

FC-19 Thousands place=0 Voltage stall protection is void.

When brake resistance is connected for quicker acceleration or deceleration, set this value.

FC-19 Thousands place=1 Under voltage stall protection is effective.

When power supply fails or bus voltage drops abruptly, to keep running normally, the inverter automatically decelerates as per proper deceleration time, and bus voltage gets normal.

FC-19 Thousands place=2 Over voltage stall protection is effective.

When bus voltage tends to be over voltage, output frequency is regulated by PID to protect bus voltage quickly.

FC-19 Thousands place=3 Both under voltage stall and over voltage stall are effective.

When bus voltage is not reasonable, bus voltage protection is taken by corresponding regulation.

8.13.15 Setting Overvoltage Protection Threshold

No.	Function	Range	Unit	Default	Type
FC-20	Voltage at Overvoltage Stall	120.00~140.00	%	130.00	○
FC-21	Overcurrent Stall Proportion Gain IKp	0.00~100.00		0.10	○
FC-22	Overvoltage Stall Proportion Gain VKp	0.00~100.00		3.00	○
FC-23	Overvoltage Integral Time VTi	0.000~10.000 0.000: No integration	S	0.300	○

FC-20 is for setting the upper limit of overvoltage protection.

The default is $380 \times 1.414 \times 128\% = 687\text{VDC}$. Users do not need to adjust the value on general conditions.

FC-22 and **FC-23** are the auto-regulation parameters of internal overvoltage protection.

They are used for after-sales regulation. The defaults can meet most of application needs.

8.13.16 Fault Retry

No.	Function	Range	Unit	Default	Type
FC-24	Fault Retry Control	Ones place: Fault retry times 0: Fault retry prohibited 1~3: Fault retry for 1, 2, and 3 times 4: Unlimited fault retry Tens place: In fault retry, fault output terminals will be 0: Off 1: On		00	○
FC-25	Fault Retry Timelag	0.01 ~ 30.00	S	0.50	○
FC-26	No Fault Timelag	0.01 ~ 30.00	S	10.00	○

8.13.17 Whether Fault Retry Is Permitted and Retry Times

FC-24 ones place=0 If inverter trips fault in running process, it needs manual reset instead of auto-reset.

FC-24 ones place=1/2/3 If inverter trips fault in running process, output will stop. It will reset fault after the fault is cleared, and it will restart and run for 1/2/3 times. The time for inverter running without fault exceeds no fault timelag (F1-26). Fault retry times reset the setting value of F1-24 ones place. If fault retry times exceeds 1/2/3 times, fault still occurs, then there is no auto-reset.

FC-24 ones place=4 If inverter trips fault in running process, output will stop. After fault is cleared, inverter will reset fault automatically, and start again until resuming normal working status.



1. The start-up feature has to be taken into consideration in applications. Fault retry cannot be applied to the applications as start-up with load, or it has to alarm immediately if the inverter has no output.

2. During the interval of auto-reset, inverter blocks PWM output and motor will coast to stop.

8.13.18 External Output at Fault Retry

FC-24 tens place=0 During fault retry, fault output terminal and fault relay are off.

FC-24 tens place=1 During fault retry, fault output terminal and fault relay will be on.

8.13.19 Fault Retry Timelag

FC-25 is for controlling fault retry time-lag. Fault retry timelag refers to the time taken for

inverter to restart from fault output stop to auto-reset. The range is 0.01~30.00 seconds and can be set continuously.

FC-25 is for controlling the time for inverter to reset fault retry times. Fault occurs in running process. After reset and restart, inverter will record the times of fault reset which have been done. If there is no fault in the setting time of FC-25, inverter will clear the fault retry times automatically. No fault timelag is in the range of 0.01~30.00 seconds and can be set continuously.

Setting the running mode at restart

The function is controlled by F0-19.

8.13.20 Fault Type Options

No.	Function	Range								Unit	Default	Type
FC-27	Fault Retry Options	*	<i>OL</i>	<i>ILP</i>	<i>SLU</i>	<i>SOU</i>	<i>SOC</i>	<i>HOU</i>	<i>HOC</i>		11111111	○
		1	1	1	1	1	1	1	1			
		0: Fault retry permitted				1: Fault retry prohibited						
*: Not used												

Fault retry control is bit operation. Only the corresponding bit has to be set as 0 or 1. As shown in the table below.

Fault Code	*	<i>OL</i>	<i>ILP</i>	<i>SLU</i>	<i>SOU</i>	<i>SOC</i>	<i>HOU</i>	<i>HOC</i>
Bit	*	6	5	4	3	2	1	0
Value	*	0/1	0/1	0/1	0/1	0/1	0/1	0/1

For instance: *SOU* and *OL* fault retry is permitted, and the other faults retries are prohibited. Only the Bit 3 corresponding to *SOU* and Bit 6 corresponding to *OL* have to be set as 0, the other bits are set as 1, i.e. FC-27=10110111.

8.13.21 Setting Disabled Trips

No.	Function	Range								Unit	Default	Type
FC-28	Disabled Trips 1	<i>OL</i>	<i>ILP</i>	<i>SLU</i>	<i>SOU</i>	<i>SOC</i>	*	*	*		00000000	○
		0	0	0	0	0	0	0	0			
		0: Enabled				1: Disabled						
FC-29	Disabled Trips 2	<i>EEd</i>	<i>EEt</i>	*	*	*	<i>EMt</i>	<i>OLP</i>	<i>OH</i>		00000001	○
		0	0	0	0	0	0	1	0			
		0: Enabled				1: Disabled						
FC-30	Disabled Trips 3	*	<i>OL1</i>	<i>SOFt</i>	<i>StE</i>	<i>SrE</i>	<i>SFE</i>	<i>StP</i>	<i>EEU</i>		00000000	○
		0	0	0	0	0	0	0	0			
		0: Enabled				1: Disabled						

Bit setting value=0 After detecting the fault corresponding to the bit, inverter will stop and enter fault status.

Bit setting value=1 After detecting the fault corresponding to the bit, inverter will output

protection and remains previous status.

FC-28~ FC-20 are bit operation. Only the corresponding bit has to be set as 0 or 1. As shown in the table below.

FC-28 Disabled Trips 1

Fault Code	<i>OL</i>	<i>ILP</i>	<i>SLU</i>	<i>SOU</i>	<i>SOC</i>	*	*	*
Bit	7	6	5	4	3	2	1	0
Value	0/1	0/1	0/1	0/1	0/1	0/1	0/1	0/1

FC-29 Disabled Trips 2

Fault Code	<i>EEI</i>	<i>ESL</i>	*	*	*	<i>EHL</i>	<i>OLP</i>	<i>OH</i>
Bit	7	6	5	4	3	2	1	0
Value	0/1	0/1	0/1	0/1	0/1	0/1	0/1	0/1

FC-30 Disabled Trips 3

Fault Code	*	<i>OLI</i>	<i>SOFI</i>	<i>SE</i>	<i>SE</i>	<i>SFE</i>	<i>StP</i>	<i>EEU</i>
Bit	7	6	5	4	3	2	1	0
Value	0/1	0/1	0/1	0/1	0/1	0/1	0/1	X

For instance: To disable Fault ILP only needs to set Bit 6 corresponding to ILP as 1, i.e. FC-28=01000000.

To disable Fault OLP and EST only needs to set Bit 1 corresponding to OLP and Bit 6 corresponding to EST as 1, i.e. FC-29=01000010.



1. Unless special needs, please do not disable any protection function in order to avoid that inverter is damaged if there is not fault protection when the faults occurs.
2. OL1 is motor overload. Fault display is also as OL. Generally, motor overload is longer than inverter overload, so that the relative settings do not need to be changed.

8.14 Fd Group: Auxiliary Parameters

8.14.1 Customer Defined V/F Curve Setting

No.	Function	Range	Unit	Default	Type
F1-04	Frequency Base		Hz	50.00	○
Fd-01	Voltage 1		%	1.00	●
Fd-02	Voltage 2		%	4.00	●
Fd-03	Voltage 3		%	10.00	●
Fd-04	Voltage 4		%	16.00	●
Fd-05	Frequency 1		%	1.00	●
Fd-06	Frequency 2		%	4.00	●
Fd-07	Frequency 3		%	10.00	●
Fd-08	Frequency 4		%	16.00	●

F1-04 ~Fd-08 parameters are enabled when F0-15=35. User defined V/F curve is determined by the curve set by percentage of input frequency and percentage of output voltage. It is linearized at different segments in different input ranges. F1-04 base frequency is the final reached frequency of V/F curve. It is also the corresponding value to maximum output voltage.

Input frequency percentage: Frequency base $F_{base}=100.0\%$. Output voltage percentage: Rated voltage $U_c=100.0\%$. Usually frequency base is the same as the rated frequency of motor.



1. If the slop of V/F curve is too big, overcurrent may occur.
2. EM303B takes the motor frequency as the frequency base. 100.00% voltage is motor rated voltage. Please make sure that the motor frequency and voltage setting are correct.

8.14.2 Auto-Torque Boost

No.	Function	Range	Unit	Default	Type
Fd-09	Torque Boost Voltage	0.00~10.00	%	0.00	●
Fd-10	Cut-off Frequency of Torque Boost	0.00~100.00	%	20.00	●

Fd-09 and **Fd-10** are to boost the low frequency torque of inverter, and to output high torque at low frequency. The parameters cannot be set too big, otherwise, it will cause overcurrent. If overcurrent fault is caused by the parameters, Fd-09 and Fd-10 can be set smaller.

See the Figure below for setting method:

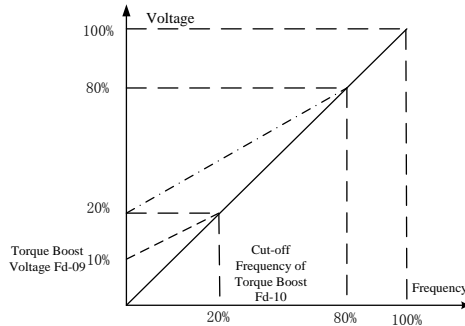

Remarks: If Fd-09=10%, its low frequency voltage curve is shown as the bold dotted line.

8.14.3 Output Voltage Control in VF Separation Mode

No.	Function	Range	Unit	Default	Type
Fd-11	Output Voltage Setting Mode in VF Separation Mode	0:Disabled		0	○
		1:Numeric Setting(FC-15)			
		2: VP Setting			
		3: VS Setting			
		4: VF Setting			
		5: IS Setting			
6: IF Setting					

If setting Fd-11 ≠ 0, the system will enter VF separation mode. After entering VF separation mode, please set F0-28=1, the parameters will be of VF separation mode.

Remarks: When setting Fd-11=0 and F0-28=1, and pressing enter, the parameters will be reset to defaults. The system will exit VF separation mode.

No.	Function	Range	Unit	Default	Type
Fd-12	Voltage Change Time	0.00~60.00	S	5.00	●

Fd-12 is for adjusting the change rate of VF separation mode. The change base is changing time of 0%~100%..

No.	Function	Range	Unit	Default	Type
FC-15	Output Voltage	0.00~100.00	%	100.00	●

When Fd-11=1, FC-15 is for adjusting output voltage. 0~380V is corresponding to 0%~100%.

8.14.4 Review Inverter Parameters

No.	Function	Range	Unit	Default	Type
Fd-21	Inverter Rated Power	0.40~480.00	kW	XXXX	X
Fd-22	Inverter Rated Voltage	60~660	V	XXX	X
Fd-23	Inverter Rated Current	0.1~1500.0	A	XXXX	X

Parameters of Fd-21~ Fd-23 are read only for the users. Please check if the parameters are in accordance with the nameplate before inverter start-up.

8.14.5 Review and Setting Running Time of Inverter

No.	Function	Range	Unit	Default	Type
Fd-24	Inverter Running Time	User monitoring	HOURL	XXXX	X
Fd-25	Inverter Running Time	User monitoring	min	XXXX	X
Fd-26	Running Time Control	0:Disabled 1:Enabled		0	-
Fd-27	Set Running Time	0~65535	HOURL	0	-

Parameters of Fd-24~ Fd-27 are read only for the users. When running timeance with the nameplate before invert would not work. If inverter runs again, it will trip fault INP (Internal Trip).

No.	Function	Range	Unit	Default	Type
Fd-28	Distributor Password				
Fd-29	Manufacturer Password				

Fd-28~ Fd-29 are for professionals only. It is to prevent the fault caused by editing the key parameters of inverter.

8.14.6 Reviewing Software Version

No.	Function	Range	Unit	Default	Type
Fd-20	CPUB Software Version	X.XX		X.XX	X
Fd-30	Keypad Software Version	X.XX		X.XX	X

Fd-31	CPUA Software Version	X.XX		X.XX	X
--------------	-----------------------	------	--	------	---

Fd-20, F3-30, and Fd-31 are read only for the users.

8.15 FE Group: User Defined Terminal Function Parameters

Input/Output Terminal Control Options

8.15.1 Programmable Input/Output Terminal Options

No.	Function	Range	Unit	Default	Type
FE-00	Numeric Input Filter Times	0~100; 1=0.50mS		10	○

Because input terminal adapts level triggered mode or pulse triggered mode, when inverter is reading terminal status, the multi-function input terminal signals have to be processed by digital filtering in order to avoid interference.

- FE-00 does not need to be adjusted on general conditions. When adjustment is required, please note the relations between filter times and lasting time when terminal is on. It is to avoid that inverter is ease to be interfered due to insufficient filter times, or slow response or command loss due to too many filter times.

8.15.2 Options of Input Terminal Logic

No.	Function	Range							Unit	Default	Type
		X7	X6	X5	X4	X3	X2	X1			
FE-01	Terminal Input Positive/Negative Logic	X7	X6	X5	X4	X3	X2	X1		00000000	○
		0	0	0	0	0	0	0			
		0: Positive Logic. On at 0V/Off at 24V 1: Negative Logic. Off at 0V/ On at 24V									

FE-01=0 Positive logic, multi-function terminal is on at 0V, and off at 24V.

FE-01=1 Negative logic, multi-function terminal is off at 0V, and on at 24V.

The function is used for matching the logic of external device.

8.15.3 Input Terminal Delay Time Setting

No.	Function	Range	Unit	Default	Type
FE-02	X1 Input Delay Time	0.00~300.00	S	0.00	○
FE-03	X2 Input Delay Time	0.00~300.00	S	0.00	○

FE-02 and FE-03 are for setting how long the inverter will delay to response when external signals reached.

8.15.4 Analog Input Signal Options and Multi-function Terminal Extension

No.	Function	Range	Unit	Default	Type
FE-04	Analog Input Signal Options	Ones place: VS input signal options 0: Analog signal input 1: Numeric signal input Tens place: IS input signal options 0: Analog signal input 1: Numeric signal input Hundreds place: VF input signal options		0000	○

		0: Analog signal input 1: Numeric signal input Thousands place: IF input signal options 0: Analog signal input 1: Numeric signal input			
--	--	--	--	--	--

FE-04 ones place=0 Analog voltage signal VS input

FE-04 ones place =1 Utilized as multi-function input terminal

FE-04 tens place =0 Analog current signal IS input

FE-04 tens place =1 Utilized as multi-function input terminal

FE-04 hundreds place =0 Analog voltage signal VF input

FE-04 hundreds place =1 Utilized as multi-function input terminal

FE-04 thousands place =0 Analog current signal IF input

FE-04 thousands place =1 Utilized as multi-function input terminal

- FE-04 is equivalent to 4 additional multi-function input terminals.

No.	Function	Range	Unit	Default	Type
FE-05	Analog Terminal Input Logic	Ones place: Input terminal VS 0: VS is on at high level input 1: VS is off at low level input Tens place: Input terminal IS 0: IS is on at high level input 1: IS is off at low level input Hundreds place: Input terminal VF 0: VF is on at high level input 1: VF is off at low level input Thousands place: Input terminal IF 0: IF is on at high level input 1: IF is off at low level input		0000	○

When FE-04 selects numeric input mode, FE-05 sets the effective logic of input signal. For instance: set FE-04 ones place=1.

If FE-05 ones place=0, terminal VS is on at high level input. If FE-05 ones place=1, terminal VS is on at low level input.

8.15.5 Relay and Multi-function Terminal Output Logic Control

No.	Function	Range	Unit	Default	Type
FE-06	Output Signal Type	Ones place: Y1 output type 0: Level signal 1: Pulse signal Tens place: Y2 output type 0: Level signal 1: Pulse signal Hundreds place: R1 output type 0: Level signal 1: Pulse signal		000	○
FE-07	Terminal Output Logic Options	Ones place: Y1 output logic options 0: Positive logic 1: Negative logic		000	○

		Tens place: Y2 output logic options 0: Positive logic 1: Negative logic Hundreds place: R1 output logic options 0: Positive logic 1: Negative logic			
--	--	--	--	--	--

FE-06 and FE-07 set the output waveform of relay and multi-function terminal. For instance: If setting FE-07 ones place=0(Positive logic), FE-06 ones place selects pulse signal or voltage signal, as shown in Figure 7-36. If setting FE-07 ones place=1 (Negative logic), FE-06 ones place selects pulse signal or voltage signal, as shown in Figure 7-37. Pulse time is set by FE-10.

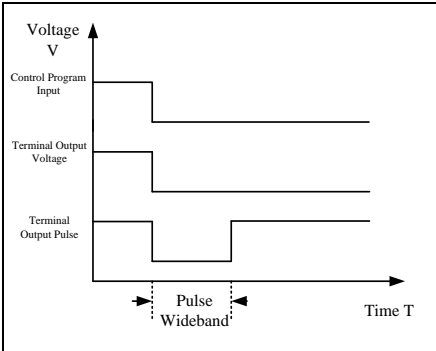

Figure7-36 Output Waveform Selection

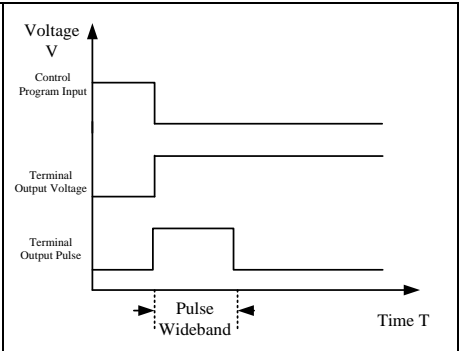

Figure7-37 Output Waveform Selection

8.15.6 Virtual Terminal Function

No.	Function	Range	Unit	Default	Type
FE-08	Virtual Terminal Options	Ones place: Terminals Y1/Y2/R1 0: Actual output terminal 1: Virtual output terminal Tens place: Multi-function Input Terminal Xi 0: Actual output terminal 1: Virtual output terminal Hundreds place: Numeric terminal VS/IS/VF/IF 0: Actual output terminal 1: Virtual output terminal		000	○

Terminal control selects actual terminal, analog communication to control on/off of terminal, input is set as enabled or disabled, or output is forced output or forced to be off. See the Appendix for communication format and data.

8.15.7 Relay and Multi-function Terminal Output Time Control

No.	Function	Range	Unit	Default	Type
-----	----------	-------	------	---------	------

FE-09	Terminal Y1 Delay Time	0.0~600.0	S	0.0	○
FE-10	Terminal Y1 Pulse Width	0.0~600.0	S	5.0	○
FE-11	Terminal Y2 Delay Time	0.0~600.0	S	0.0	○
FE-12	Terminal Y2 Pulse Width	0.0~600.0	S	5.0	○
FE-13	Terminal R1 Delay Time	0.0~600.0	S	0.0	○
FE-14	Terminal R1 Pulse Width	0.0~600.0	S	5.0	○

Terminal Y1 will be taken as an example to describe the function of terminal delay time. If setting FE-07 ones place=1, FE-06 ones place selects pulse signal or voltage signal, as shown in Figure 7-38.

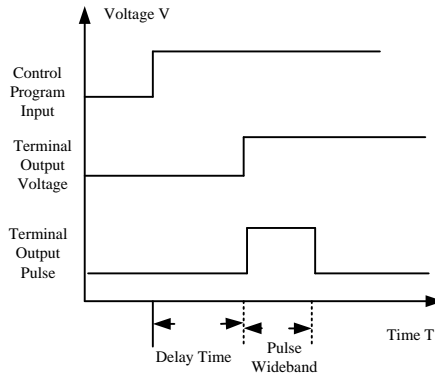

Figure 7-38 Terminal Output Delay Time

8.15.8 Distinguish Similar Faults

No.	Function	Range	Unit	Default	Type
FE-20	$S\mathcal{L}$ and $\mathcal{E}\tilde{\mathcal{L}}$ Faults Display	0: $S\mathcal{L}$ Drive failure 1: $\mathcal{E}\tilde{\mathcal{L}}$ Environment failure		0	X
FE-21	$S\mathcal{L}U$ and $S\mathcal{B}F\mathcal{t}$ Faults Display	0: $S\mathcal{L}U$ Stable undervoltage fault 1: $S\mathcal{B}F\mathcal{t}$ Soft-start fault		0	X
FE-22	$S\mathcal{L}!$ / $S\mathcal{P}!$ / $P!$ Faults Display	0: $S\mathcal{L}!$ Fault 1: $S\mathcal{P}!$ Fault 2: PID feedback loss fault		0	X
FE-23 ~ FE-31	Not Used				

In order to distinguish the faults clearly which are in similar logic or share the same fault display code, the specific fault type can be confirmed by reviewing the setting value of FE-20, FE-21, and FE-22.

9 Autotuning Motor Parameters

9.1 Autotuning Motor Parameters

Autotuning motor parameter is required when the inverter is in vector control mode. However, if the inverter is not in vector control mode, parameter autotuning is also suggested for acquiring higher control precision at initial operation.

Generally, it is not easy for user to obtain the motor parameters that are needed for calculation in vector control mode such as stator resistance $R1$, rotor resistance $R2$, stator and rotor inductance Lm , stator and rotor leakage inductance Ls , idling excitation current $I0$. EM303B provides function of motor parameter autotuning. After the function start-up, inverter autotunes the relevant parameters of the motor connected and saves them to the EEPROM.

The T equivalent model of motor is as shown in Figure 8-1.

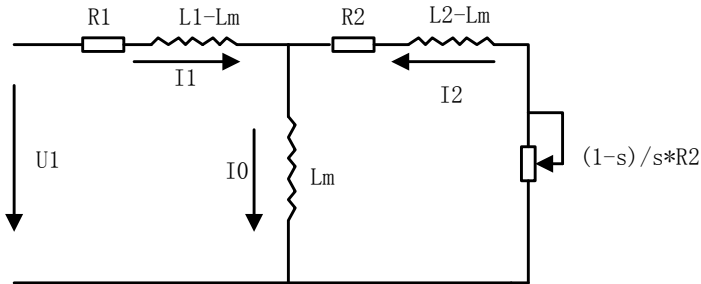

Figure 8-1 T Equivalent Model of 3-phase AC Induction Motor

$R1$, $L1$, $R2$, $L2$, Lm , and $I0$ in Figure 8-1 refers to stator resistance, stator inductance, rotor resistance, rotor inductance, stator and rotor mutual inductance, and idling excitation current respectively. Leakage inductance $Ls=L-Lm$.

9.2 Precautions Before Autotuning



- Autotuning is a process of autotuning motor parameters. EM303B can autotune motor parameters in 2 modes: stationary autotuning and rotational autotuning.
 - Stationary autotuning is applied to the occasions when the motor cannot be disconnected from the load, inverter can obtain motor parameters.
 - Rotational autotuning is applied to the occasions when the motor can be disconnected from the load. Before autotuning, the motor should be disconnected from the load. Never perform rotational autotuning for a motor with load.
- Make sure that the motor stops before autotuning, otherwise, autotuning cannot be performed normally.
- Autotuning is only enabled when the inverter is in keypad control mode. (F0-04=0)
- To ensure a smooth autotuning, set all motor parameters as per the values listed on motor nameplate correctly:
 - F1-00: Motor model
 - F1-01: Motor rated power

- F1-02: Motor rated voltage
- F1-03: Motor rated current
- F1-04: Motor rated frequency
- F1-05: Motor rated speed
- F1-06: Motor wiring method
- F1-07: Motor rated power factor

Based on the rated power of the inverter, match inverter with an applicable Y-series motor, and the defaults of motor can meet most of needs.

- To ensure control performance, the motor and the inverter should match in terms of the power rating. Usually the power rating of motor is only allowed to be one level lower than that of the inverter.
- After autotuning is over normally, the setting value of F1-08uld match in terms of the power raved.
- When F0-28=1 reset the default, the parameters of F1-00 F1-08uld match in terms

9.3 Autotuning Procedure

- In parameter setting status, set F0-04=0, and make motor offload.
- Set all motor parameters as per the values listed on nameplate correctly:
 - F1-00: Motor model
 - F1-01: Motor rated power
 - F1-02: Motor rated voltage
 - F1-03: Motor rated current
 - F1-04: Motor rated frequency
 - F1-05: Motor rated speed
 - F1-06: Motor wiring method
 - F1-07: Motor rated power factor
- Set F1-15=1, inverter performs stationary autotuning.
- Set F1-15=2, inverter performs rotational autotuning.
- It takes about 2 minutes to finish autotuning motor parameters, and the keypad displays returns the initial power-on status.
- Pressing  to cancel autotuning in autotuning, and inverter will return parameter setting status.
- If autotuning fails, inverter will trip faults of SrE (Stator Resistance Error) or SIE (Idling Current Error). Pressing , inverter will return parameter setting status.

Remarks:

The autotuned motor parameters will not vary with motor status. But motor parameters will vary with temperature changes. If the motor is running with heavy load for a long time and motor temperature lasts higher for a long time, and in order to obtain a better performance, it is suggested to autotune motor parameters when motor temperature is high after running with heaving load. If the motor is running with light load, autotuning shall be conducted when motor is in cold status.





10 Troubleshooting

10.1 Faults

When anything unexpected happens, the corresponding trip code and parameters will be displayed on the keypad, fault relay is on and fault output terminal is on, inverter output stops. When fault occurs, if the motor is running, it will coast to stop. See Table 9-1 for EM303B fault trips and troubleshooting.

Table 9-1 EM303B Fault Trips and Troubleshooting

Trip Code	Trip	Cause	Corrective Action
<i>SC</i>	Short Circuit	<ol style="list-style-type: none"> 1. Short circuit between inverter output phases, or between the output phases and ground. 2. IGBT is damaged. 3. On-site interference. 	<ol style="list-style-type: none"> 1. Check if there is a short circuit. 2. Check, take corrective actions, and then reset. 2. Technical support is required.
<i>HOC</i>	Instantaneous Overcurrent	<ol style="list-style-type: none"> 1. Short circuit between inverter output phases or between the output phases and ground. 2. The acceleration/deceleration time is too short. 3. In V/F control mode, the setting value of torque boost is too big. 4. The motor is rotating when inverter starts. 5. The capacity of motor exceeds that of inverter, or the load the too heavy. 	<ol style="list-style-type: none"> 1. Check, take corrective actions, and then reset. 2. Prolong acceleration/deceleration time 3. Reduce setting value of torque boost. 4. Set speed search start enabled, or start DC brake. 5. Replace with applicable motor or inverter.
<i>SOC</i>	Stable Overcurrent		
<i>HOU</i>	Instantaneous Overvoltage	<ol style="list-style-type: none"> 1. Deceleration time is too short. The motor regenerative energy is too much. 2. Power supply voltage is too high. 	<ol style="list-style-type: none"> 1. Prolong deceleration time. 2. Install applicable braking unit and braking resistor. 3. Lower the power supply voltage to the rated voltage.
<i>SOU</i>	Stable Overvoltage	<ol style="list-style-type: none"> 1. Voltage of power grid is too high. 2. Deceleration time is too short. 	<ol style="list-style-type: none"> 1. Lower voltage to the rated voltage. 2. Prolong the deceleration time.

Trip Code	Trip	Cause	Corrective Action
<i>SLU</i>	Stable Undervoltage/SOFT Soft-start failure	<ol style="list-style-type: none"> 1. Input power phase loss. 2. Wiring terminal of input power is loose. 3. Input power voltage drops too much. 4. Switch contact of input power is aging. 	<ol style="list-style-type: none"> 1. Check input power supply. 2. Tighten screws on input terminals. 3. Check air switch and contactor.
<i>ILP</i>	Input Phase Loss	<ol style="list-style-type: none"> 1. Input power phase loss. 	<ol style="list-style-type: none"> 1. Check input power supply. 2. Check wiring of input power supply. 3. Check if wiring terminal is loose.
<i>OL</i>	Overload/Stall Time Is too Long (The faults of OL and OL1 are displayed as OL.)	<ol style="list-style-type: none"> 1. Acceleration/deceleration time is too short. 2. In V/F control mode, the setting value of torque boost is too big. 3. Load is too heavy. 4. Inverter is in stall status for a long time. 	<p>Prolong acceleration/deceleration time.</p> <p>Reduce setting value of torque boost.</p> <p>Replace with the inverter which is applicable to the load.</p> <p>Check if the motor cannot stop by other load.</p>
<i>OH</i>	Heat Sink Overheating	<ol style="list-style-type: none"> 1. Ambient temperature is too high. 2. Poor ventilation. 3. Cooling fans are broken down. 	<p>The service environment of inverter should meet the requirements.</p> <p>Improve environmental ventilation, and check if the vent of inverter is blocked.</p> <p>Replace air cooling fan.</p>
<i>EIF</i>	External Fault	<ol style="list-style-type: none"> 1. External device fault terminal is on. 	<ol style="list-style-type: none"> 1. Check external device.
<i>INP</i>	Internal Faults	<ol style="list-style-type: none"> 1. The system running time is up. 	Please contact the distributor.
<i>EEF</i>	Inverter EEPROM Failure	<ol style="list-style-type: none"> 1. Interference makes EEPROM read-write mistakes. 	<ol style="list-style-type: none"> 1. Press  to reset, and then retry.
<i>EEU</i>	Keypad EEPROM Failure	<ol style="list-style-type: none"> 2. EEPROM is damaged. 	<ol style="list-style-type: none"> 2. Technical support is required.
<i>STP</i>	Autotuning Cancelled	<ol style="list-style-type: none"> 1. During autotuning, press . 	<ol style="list-style-type: none"> 1. Press  to reset.
<i>SFE</i>	Coast-to-stop in Autotuning	<ol style="list-style-type: none"> 1. In the process of autotuning, the external coast-to-stop terminal FRS=ON. 	<ol style="list-style-type: none"> 1. Press  to reset.

Trip Code	Trip	Cause	Corrective Action
<i>SrE</i>	Stator Resistance Error	1. Motor is not connected to the output terminals of inverter. 2. Motor is on load. 3. Motor fails.	1. Check connection between inverter and motor. 2. Motor is offloaded. 3. Check motor.
<i>SiE</i>	Idling Current Error		
<i>EstE</i>	PID Feedback Loss/SPI Fault/SCI Fault	1. PID feedback loses. 2. Analog terminal of PID feedback is broken down. 3. PID feedback detection time is too short, fault is caused by interference. 4. Internal SPI communication fault. 5. SCI communication fault.	1. Check the cable between PID feedback sensor and analog terminal. 2. Check if the analog terminal is broken. 3. Increase the value of F4-31. 4. Power-on the inverter again after power failure. 5. Adjust F1-30 communication overtime.
<i>OLP</i>	Output Phase Loss	1. The motor is not connected to the output terminal of inverter. 2. Motor vibrates severely, and 3-phase current is in serious imbalance.	1. Check connection between inverter and motor. 2. Check if the motor is damaged.

When inverter trips faults as stated above, press  or use reset terminal to clear fault. If the fault is cleared, inverter will return the function setting status. Otherwise, the trip code will be displayed on LED continuously.

When faults trip in operation, if fault retry (set by FC-24) is enabled, the inverter will reset fault automatically and try to run after certain setting interval time (set by FC-25). FC-24 sets the retry times of fault reset. If the fault times exceeds the setting value of FC-26(No fault time-lag), the inverter stops retry and keeps in fault status.

Reference of LED Characters

LED Characters and the Corresponding English Characters

<i>A</i>	<i>b</i>	<i>C</i>	<i>d</i>	<i>E</i>	<i>F</i>	<i>G</i>	<i>H</i>	<i>I</i>	<i>L</i>
A	B	C	D	E	F	G	H	I	L

<i>n</i>	<i>O</i>	<i>P</i>	<i>Q</i>	<i>r</i>	<i>S</i>	<i>t</i>	<i>U</i>	<i>H</i>	<i>y</i>
N	O	P	Q	R	S	T	U	X	Y





LED numbers and the Corresponding English numbers

<i>1</i>	<i>2</i>	<i>3</i>	<i>4</i>	<i>5</i>	<i>6</i>	<i>7</i>	<i>8</i>	<i>9</i>	<i>0</i>
1	2	3	4	5	6	7	8	9	0

10.2 Fault Analysis

After power is on, due to improper function setting and incorrect wiring between inverter and external control terminals, motor cannot meet the expected working requirements. Fault analysis as described in this chapter can be taken as the reference to take as the corrective actions. If trip codes appear, see 9.1 for the corrective actions to clear the trips.

10.2.1 Parameter Setting Failures

- Press /, the parameters remain unchanged.
Some parameters can only be edited when the inverter stopped.
- Press /, parameter changes, but they cannot be saved.
Some parameters cannot be edited since they are locked.

10.2.2 Abnormal Motor Operation

- Press  button, the motor does not run.
 - Start/Stop is in terminal control mode: Check the setting of F0-04.
 - Coast-to-stop terminals FRS is connected to COM: Disconnect FRS from COM.
 - When the terminal (Run Command Switched to Terminal) is on, meanwhile the run command is only in terminal control mode: Switch the terminal off.
 - Status combination of run command input is in terminal control mode: Change it to keypad control mode.
 - Setting reference input frequency= 0: Increase reference input frequency.
 - Power supply is abnormal or control circuit fails.
- Control terminals RUN, F/R=ON, the motor does not run.
 - The external terminal start/stop setting is disabled: Check the setting of F0-04.
 - Coast-to-stop terminal FRS=ON: Switch FRS=OFF.
 - Control switch is disabled: Check control switch.
 - Setting reference input frequency=0: Increase reference input frequency.
- Motor can only run in one direction.
Reverse prohibited: When F0-24=1, the inverter reverse is prohibited.
- Motor reverses
The output phase sequence of inverter is not identical to that of motor input: When power is off, the running direction of motor can be changed by switching any of the two connection wires at output side of inverter, or editing F0-08 when power is on.

10.2.3 Excessively Long Acceleration Time

- Excessively low setting of current limit
When setting current limit is enabled, if the output current of inverter reaches its setting current limit (FC-08), then, the output frequency will remain unchanged in the process of acceleration, and it will rise continuously only until output current is lower than the setting current limit. In this case, the acceleration time of motor is longer than the setting time. Check if the setting current limit of inverter is excessively low.

- If the setting acceleration time is too long, confirm its parameters.

10.2.4 Excessively Long Deceleration Time

- When dynamic brake enabled
 - The brake resistance is too big. The dynamic brake power is too small, so the deceleration time is prolonged.
 - The setting value of brake duty ratio (FC-16) is too small, and the deceleration time is prolonged, please increase the setting value of brake duty ratio.
 - The setting deceleration time is too long, confirm its parameters.
- When overvoltage stall protection enabled
 - Overvoltage stall protection is enabled, when DC bus voltage exceeds DC690V, the output frequency remains unchanged. When it is lower than the setting value of FC-20, the output frequency drops continuously, therefore the deceleration time is prolonged.
 - The setting deceleration time is too long, please check its parameters.

10.2.5 Inverter Overheating

- Excessively heavy load
 - Heavy load makes inverter work beyond its rated current for a long time. The power of inverter shall match that of motor.
 - The motor rotor is blocked due to the failure of motor or load fault.
- Excessively high ambient temperature

When the ambient temperature of inverter exceeds the permitted value, the temperature might exceed the permitted highest value of inverter when it works in the rated status.

10.2.6 Electromagnetic Interference (EMI) and Radio-frequency Interference (RFI)

- When inverter runs in high frequency switch status, it will generate EMI and RFI on the control devices. Take following countermeasures:
 - Lower the carrier frequency (F0-14) of inverter.
 - Install noise filter on input side of inverter.
 - Install noise filter on output side of inverter.
 - Shield cable with a metal tube, and place the inverter in a metal case.
 - Reliable grounding for the inverter and motor.
 - The main circuit and the control circuit should be separated in terms of wiring. Control circuit should take shielded wire, and see Chapter 3 for wiring.

10.2.7 Leakage Current Circuit Breaker for Leakage Protection

- When inverter runs, the leakage current circuit breaker is triggered for leakage protection.

Since inverter outputs high frequency PWM signal, it will generate high frequency

leakage current. Select a special leakage circuit breaker with a trigger current $\geq 30\text{mA}$, or a regular leakage circuit breaker with a trigger current $\geq 200\text{mA}$ and the action time $\geq 0.1\text{S}$.

10.2.8 Mechanical Vibration

- The fixed frequency of mechanical system resonates with the carrier frequency of inverter.

If there is no problem with the motor, but the machine resonates a sharp noise due to the resonance between the fixed frequency of mechanical system and the carrier frequency of inverter. Please adjust the carrier frequency F0-14, and F7-20~F7-22 of inverter to avoid resonant frequency.

- The fixed frequency of mechanical system resonates with the output frequency of inverter.

A mechanical noise is generated due to the fixed frequency of mechanic system resonating with the output frequency of inverter. Please use skip frequency F6-16~F6-21 and its range to avoid resonant frequency, or use oscillation suppression function (F9-27), or install the shake-proof rubber on the chassis of motor or any other shake-proof measures.

- PID Control Oscillation

Improper setting of PID controller's regulation parameters P, Ti and Td, please reset PID parameters.

10.2.9 Inverter Stops Output While Motor Runs

- Insufficient DC brake at stop
 - DC brake torque at stop is too small. Please increase setting value of DC brake current at stop (F3-25).
 - DC braking time is too short at stop. Please increase setting value of DC brake time (F3-27). Generally, please increase the DC brake current at stop first.

10.2.10 Output Frequency Does Not Output as per the Setting Frequency

- The setting frequency is within the range of skip frequency
The function of skip frequency is to forbid the inverter to output within the skip frequency range. Please check if the skip frequency of F6-16~F6-21 and its range are proper.
- The setting frequency exceeds the upper limit frequency
When the setting frequency exceeds the setting value of upper limit frequency, output frequency outputs as per the upper limit frequency. Reset the setting frequency to make it within the range of upper limit frequency, or check whether F0-16 and F0-17 are proper.

11 Maintenance and Inspection

11.1 Maintenance and Inspection

Due to the service environmental changes such as temperature, humidity, smoke, frost, dust, or the factors as aging of inverter's internal components, various failures of inverter may occur. Therefore, it is required to have daily check and keep regular maintenance on inverter during use and storage.

- Check if the components are broken or the screws are loose during transportation.
- Clean the inverter and periodically check if the screws are loose.
- Power-on the sleeping inverters for 30 minutes once semiannually to prevent electronic components from being disabled.
- Keep inverter away from heavy humidity and metal particles. If necessary, put it in an electric cabinet or a small room with protective measures.

11.2 Daily Inspection

Check the following items with the inverter in operation:

- The motor should not be vibrating or making unusual sound.
- Inverter and motor should not be overheating.
- The ambient temperature should not be too high.
- The output current value shown on the monitoring displays should not be higher than normal value.
- The cooling fan at the bottom of the inverter should be in normal operation.

11.3 Periodic Maintenance

Periodic maintenance ensures that the inverter receives the proper care to maintain overall performance. Always turn the power supply off before inspection, and the inspection starts only after the indicator CHARGE on main circuit power supply is off.

Table 10-1 Periodic Maintenances

Item	Checks	Corrective Action
Main circuit terminals, screws on control circuit terminals	Are all screws tight?	Tighten loose screws firmly.
Heat Sink PCBA	Are there dirty or dusty?	Clean any dirt and dust off with an air gun using dry air at a pressure of 4~6kg/cm ²
Cooling fan	Is there any unusual noise or vibration or has the total operating time exceeded 20,000 hours?	Replace the cooling fan.
Power Components	Are they dusty?	Clean any dirt and dust off with an air gun using dry air at a pressure of 4~6kg/cm ²
Electrolytic Capacitor	Are there any irregularities such as discoloration or odor?	Replace the capacitor.

11.4 Periodic Maintenance and Replacement of Parts

In order to keep the inverter operating normally over a long period of time, periodic maintenance and replacement are required for the internal parts according to their service lives. Periodic maintenance standards vary from the inverter's service environment and applications. See Table 10-2 for the part replacement guidelines.

Table 10-2 Part Replacement Guidelines

Parts	Standard Replacement Period
Cooling Fan	2~3 Years
Electrolytic Capacitor	4~5 Years
PCBA	5~8 Years

The standard replacement period is based on the following application conditions:

- Ambient temperature: Yearly average of 30°C
- Load factor: 80% maximum
- Operation rate: 12 hours maximum per day

11.5 Outline of Warranty

SINEE will provide warranty service under following circumstances:

1. Warranty is only for inverter.
2. Authorized distributors of SINEE will take responsibilities for local services within 12 months warranty period.
3. There is a maintenance charge for any following damage occurred in 12 months.
 - Due to improper operation.
 - Due to unauthorized installation environment.
 - Due to floods, fires, or abnormal voltage fluctuations.
 - Due to the incorrect wiring.
 - Due to unauthorized modifying or altering.

12 Accessories

12.1 Keypad Extension Wire

Optional keypad extension wires available in the table below, select based on real needs.

Parameter Name	Specifications	Remarks
Keypad Extension Wire	EM303-3 m	
Keypad Extension Wire	EM303-4 m	
Keypad Extension Wire	EM303-5 m	
Keypad Extension Wire	EM303-6 m	
Keypad Extension Wire	EM303-8 m	
Keypad Extension Wire	EM303-10 m	
Keypad Extension Wire	EM303-12 m	Special Remote Control Keypad Required
Keypad Extension Wire	EM303-15 m	Special Remote Control Keypad Required
Keypad Extension Wire	EM303-20 m	Special Remote Control Keypad Required
Keypad Extension Wire	EM303-30 m	Special Remote Control Keypad Required

- When keypad extension wire exceeds 10 meters, it is required to use the special remote operation keypad in case of signal disorder caused by line loss.
- When keypad extension wire exceeds 10 meters, please take anti-interference measures to maintain inverter in normal work status.
- The external terminal control is suggested if the inverter needs to be operated beyond 20 meters.

12.2 Remote Control Case

The remote control case is applicable to the occasions when inverter needs to be simply controlled in a distance.

The functions of remote control case:

- Start / stop control and emergency stop of inverter.
- Display speed or other information through the analog voltage output of inverter.
- Adjust speed by the analog input terminals of inverter.
- Adjust speed in stepping mode through the multi-function input terminals of inverter.

Set the terminal functions of inverter correspondingly for the functions stated above.

See Figure 11-1 for the overall and installation dimensions of remote control case.

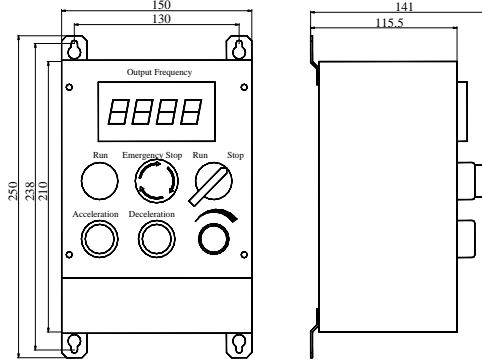

Figure 11-1 Outlook and Installation Dimensions of Remote Control Case

12.3 Braking Resistor

EM303B (0.75~15kW) with an integrated braking unit can be connected to braking resistor directly for quick stop. Please see Table 11-1 for selecting braking resistor for EM303B.

Table 11-1 Braking Resistor Selection

Inverter Model No.	Motor Power (kW)	MIN Resistor Resistance(Ω)	Resistor power (W)	Cable Size (mm ²)
EM303B-0R7G /1R1P -3B	0.75	≥ 360	≥ 112.5	1
EM303B-1R1G /1R5P -3B	1.1	≥ 360	≥ 165	1
EM303B-1R5G /2R2P -3B	1.5	≥ 180	≥ 225	1.5
EM303B-2R2G /3R0P -3B	2.2	≥ 180	≥ 330	1.5
EM303B-3R0G /4R0P -3B	3.0	≥ 180	≥ 450	1.5
EM303B-4R0G /5R5P -3B	4.0	≥ 90	≥ 600	2.5
EM303B-5R5G /7R5P -3B	5.5	≥ 60	≥ 825	4
EM303B-7R5G /9R0P -3B	7.5	≥ 60	≥ 1125	4
EM303B-9R0G /011P -3B	9.0	≥ 60	≥ 1350	4
EM303B-011G /015P -3B	11	≥ 30	≥ 1650	6
EM303B-015G /018P -3B	15	≥ 30	≥ 2250	6

Remarks:

1. See *User Manual of BR100 Braking Unit* for selecting braking resistor for EM303B-018~400.
2. Cables listed in above table refer to the lead cable of single resistor. The DC bus should be uprated if the resistors are in parallel connection.
3. Cable should withstand voltage \geq AC450V, temperature resistance :105 $^{\circ}$ C.
4. Because there is a resistor limit of power consumption, the longest operation time for 10%ED is 10S (On: 10S/ Off:90S).

12.4 Braking Unit

Separate BR100 braking unit is available for EM303B-018~400 which are without an integrated braking unit, power rang of BR100: 18.5~315kW.

SINEE-make BR100 models are as shown in the following table.

Model No.	Application	Minimum Resistance (Ω)	Average Brake Current $I_{av}(A)$	Peak Brake Current $I_{max}(A)$	Inverter Power Range (kW)
BR100-045	Dynamic Brake	10	45	75	18.5~45
BR100-160	Dynamic Brake	6	75	150	55~160
BR100-315	Dynamic Brake	3	120	300	185~315

Remarks:

When BR100-160 is with minimum resistance, and when brake duty ratio $D \leq 33\%$, braking unit can work continuously, it needs to work non-continuously when brake duty ratio $D > 33\%$. Otherwise, braking unit will trip over-heating.

12.5 Connecting Cable

Since all braking unit and braking resistors work at a high voltage ($>400VDC$) in a non-continuous working status, please select applicable cable. See Table 11-2 for specifications of main circuit cable, and take the cable which meets the insulation and cross-section requirements.

Table 11-2 Cable for Braking Unit and Braking Resistor

Model No.	Average Brake Current $I_{av}(A)$	Peak Brake Current $I_{max}(A)$	Cross-section of Copper Cable (mm^2)
BR100-045	45	75	6
BR100-160	75	150	10
BR100-315	120	300	16

Soft cable possesses a better flexibility, so copper cable, soft heat-proof cable or flame-proof cable is suggested because the cable may contact the equipment with high temperature. The distance between braking unit and inverter shall within 2m. Otherwise, the cable on DC side shall be twisted and shielded with magnetic ring to reduce radiation and induction.

Refer to *User Manual of BR100 Braking Unit* for 11.3, 11.4 and 11.5.

12.6 Chassis for Floor Mounting

6 modes, EM303B-055~075, EM303B-090, EM303B-110~132, EM303B-160~200, EM303B-220~280, and EM303B-315~400, can be floor-mounted with a chassis which is in the same width as the inverter. See Figure 11-2 as a reference. Please order the extra chassis if needed.

See Figure 11-3 as a reference for installation, and see Figure 11-4 and Table 11-3 for the installation dimensions of chassis and foundation bolts.

Table 11-3 Installation Dimensions of Chassis and Foundation Bolts

Inverter Model No.	H (mm)	W(mm)	D(mm)	d(mm)
EM303B-055~075	120mm	370	213	8
EM303B-090	253mm	300	243	13
EM303B-110~132	253mm	300	258	13
EM303B-160~200	308mm	416	293	13
EM303B-220~280	300mm	500	340	13
EM303B-315~400	355mm	720	339	13

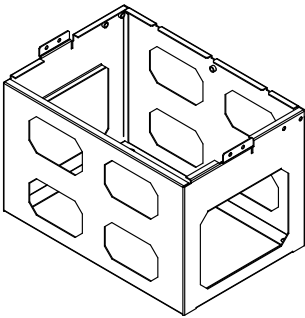

Figure 11-3 Chassis for Floor Mounting

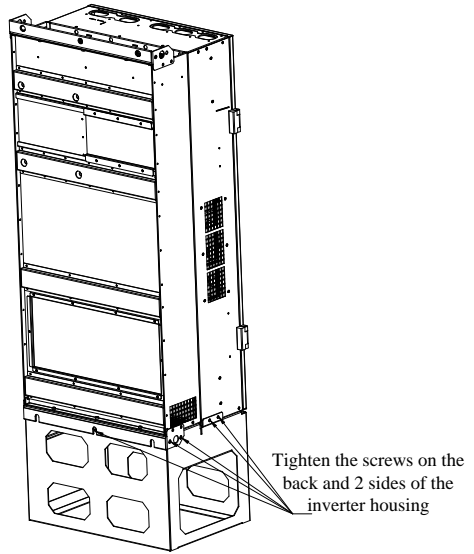

Figure 11-4 Installation Dimensions of Chassis

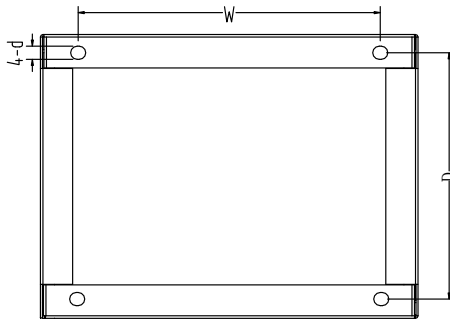

Figure 11-4 Installation Dimensions of Foundation Bolts

12.7 Extended Copper Bar

Extended copper bars are for connecting input and output cables of inverter which are only available for EM303B-220~280 and EM303B-315~400. With the help of the copper bar, the wiring can be done externally. Please order the copper bars if needed, and users take all responsibilities of the assembly of the copper bar. See Figure 11-5 for details.

Inverter Model No.	Accessories
EM303B-220~280	Copper bars, mounting bolts, insulation pins
EM303B-315~400	Copper bars, mounting bolts, insulation pins

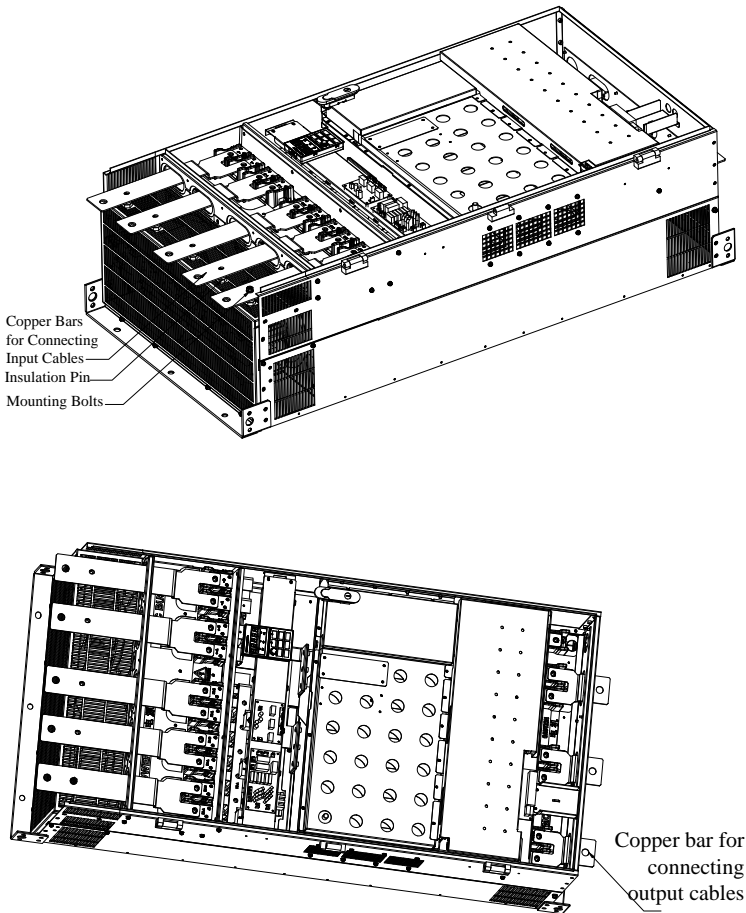

Figure 11-5 Assembling the Copper Bar

13 Modbus Communication Protocol

13.1 Application Scope

- Applicable series: EM303B
- Applicable network: Support Modbus protocol, RTU format, with single-master/multi-slave Communication network of RS485 bus.

The typical RTU message frame format:

Start Bit	Device Address	Function Code	Data	CRC	Stop Bit
T1-T2-T3-T4	8Bit	8Bit	n*8Bit	16Bit	T1-T2-T3-T4

13.2 Physical Interface

- RS485 asynchronous half-duplex Communication mode.
- Default data format of communication terminal of keypad: 1-8-N-1rbits rate: 9600bps.
- Default data format of RS485 terminal: 1-8-N-1ofe. rmat, with sing
- Data format 1-8-N-1, 1-8-O-1, 1-8-E-1, optional bits rates 4800bps, 9600bps, 19200bps, and 38400bps
- Shielded twisted-pair cable is recommended Communication cable to lower external interference.

13.3 Protocol Format

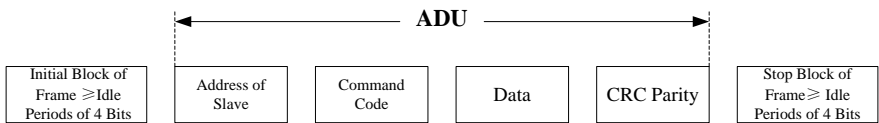

Figure 12-1 Protocol Format

The parity in ADU (Application Data Unit) is obtained via the CRC16 parity of the 1st three parts of ADU and switching the low bytes and high bytes. Low bytes of CRC parity go first, and high bytes of it follow in the protocol format.

13.4 Explanation of Command

Command code 0x03:Read parameter and status of inverter.

ADU Item	Byte No.	Range
Master requests:		
Address of slave	1	0~127
Command Code	1	0x03
Register start address	2	0x0000~0xFFFF
Register number	2	0x0000~0x0008

CRC parity(Low bytes go first)	2	
Slave responds		
Address of slave	1	Inverter address
ADU Item	Byte No.	Range
Command code	1	0x03
Byte Length	1	2* Register number
Register data	2* Register number	
CRC parity	2	

Remarks: Read maximum 8 function codes consecutively.

Command code 0x06: Write single function code or control parameter of inverter

ADU Item	Byte No.	Range
Master requests:		
Address of slave	1	0~127
Command code	1	0x06
Register address	2	0x0000~0xFFFF
Register data	2	0x0000~0xFFFF
CRC parity	2	
Slave responds:		
Address of slave	1	Inverter address
Command code	1	0x06
Register address	2	0x0000~0xFFFF
Register data	2	0x0000~0xFFFF
CRC parity	2	

Command code 0x10: Write several function codes or control parameters of inverter

ADU Item	Byte No.	Range
Master requests:		
Address of slave	1	0~127
Command code	1	0x10
Register start address	2	0x0000~0xFFFF
Register number	2	0x0000~0x0008
Byte length of register data	1	2*Register number
Register data	2* Register number	
CRC parity	2	
Slave responds:		
Address of slave	1	Inverter address
Command code	1	0x10
Register start address	2	0x0000~0xFFFF
Register number	2	0x0000~0x0008
CRC parity	2	

Remarks: Write maximum 8 function codes consecutively

Command code 0x08: Circuit Diagnosis and Setting

ADU Item	Byte No.	Range
Master requests:		
Address of slave	1	0~127
Command code	1	0x08
Sub-function code	2	0x0000~0xFFFF
Register data	2	
CRC parity	2	
Slave responds:		
Address of slave	1	Inverter address
Command code	1	0x08
Sub-function code	2	0x0000~0xFFFF
Register data	2	
CRC parity	2	

Remarks: Command code 0x08 is only for circuit check.

13.5 Description of Protocol Format

13.5.1 Address Code

Address of slave inverter. The setting range: 1~247, 0 is broadcast address.

13.5.2 Command Code

Command Code	Function
03H	Read parameters and status byte of inverter
06H	Write single function code or control parameter of inverter
10H	Write several function codes or control parameters of inverter
08H	Circuit diagnosis and setting

13.5.3 Allocation of Register Addresses

Name	Address	Description
Function Code	0000H~1F1FH (Saving Address)	High byte is the function code group number. F0~FF, C0, and E0 are corresponding to high bytes: 00H~0FH, 10H, and 11H respectively. Low byte is serial number of function code group. 0~31 corresponding to low bytes 00H~1FH. For example: the corresponding saving address of F0-06 is 0006H. The saving address is prohibited for the function codes which are modified frequently. Otherwise, the EEPROM of inverter may be damaged, and inverter will trip fault EEd.
	2000H~3F1FH (Temporary Saving Address)	For frequent modified function codes, the function code address +2000H is to prevent EEPROM of inverter from being damaged. Due to frequent modification, the value of this function code will not be saved at power failure. For example, the temporary saving address of F0-06 is

Name	Address	Description
Control Command	40xx/70xx	Refers to 12.6 description of control command
Working Status	41xx	Refers to 12.6 description of control command

13.5.4 CRC Parity

Sending equipment calculates CRC parity value first, and then attaches it to the sending message. Upon receipt of the message, receiving equipment will calculate CRC parity value again, and compare the operation result with received CRC parity value. If the two values are different, it indicates that there is error during transmission.

Calculation process of CRC parity:

1. Define a CRC parity register, and initialize it as FFFFH.
2. Conduct XOR calculation between the 1st byte of sending message and the value of CRC parity register, and then upload the result to CRC parity register. Start from address code, the start bit and stop bit will not be calculated.
3. Collect and check LSB (the least significant bit of CRC parity register).
4. If LSB is 1, shift each bit of CRC parity register rightwards by 1 bit, the highest bit filled with 0. Conduct XOR calculation between the value of CRC register and A001H, and then upload the result to CRC parity register.
5. If LSB is 0, shift each bit of CRC parity register rightwards by 1 bit, the highest bit filled with 0.
6. Repeat steps 3, 4 and 5 until completing 8 rounds of shifting.
7. Repeat steps 2, 3, 4, 5 and 6, and process the next byte of sending message. Repeat above process continuously until each byte of sending message is processed.
8. CRC parity date will be saved in CRC parity register after calculation.
9. LUT (Look-up table) method is to obtain CRC parity in the system with limited time resources.

Simple CRC functions as shown in following (C language Programming):

```

unsigned int CRC_Cal_Value(unsigned char *Data, unsigned char Length)
{
    unsigned int crc_value = 0xFFFF;
    int i = 0;
    while(Length--)
    {
        crc_value ^= *Data++;
        for(i=0;i<8;i++)
        {
            if(crc_value & 0x0001)
            {
                crc_value = (crc_value>>1)^ 0xa001;
            }
        }
    }
}

```



```

}
    else
    {
        crc_value = crc_value>>1;
    }
}
}
return(crc_value);
}

```

12.5.5 Error Message Response

Inverter will send an error message report when the master sends error data or inverter receives the error data due to the external interference.

When Communication error occurs, slave combines the highest bit 1 of command code and error code as the response to the master.

Responding data frame format when errors happened in Communication:

ADU Item	Byte No.	Range
Error response:		
Address of slave	1	0~127
Error command code	1	The highest bit 1 of command code
Error code	1	0x01~0x13
CRC parity(Low bytes go first)	2	

Responding command code at normal Communication and error Communication

Responding Command Code at Normal Communication	Responding Command Code at Error Communication
03H	83H
06H	86H
10H	90H
08H	88H

Description of Error Code

Error Code	Description	Error Code	Description
01H	Exceptional command code	06H	Slave is busy
02H	Exceptional data address	10H	Frame error: Frame length error, parity error
03H	Exceptional data	11H	Parameter read only
04H	Slave operation failure	12H	Parameter is uneditable in operation.
05H	Command enabled, in the process	13H	Parameter is protected by password

For instance: Master sends data frame in hexadecimal format for F0-00to write 50.00HZ frequency.

01H	06H	00H	00H	13H	88H	84H	9CH
-----	-----	-----	-----	-----	-----	-----	-----

Because F0-00is read only, inverter responds error message. Inverter responds data frame in hexadecimal format

01H	86H	11H	82H	6CH
-----	-----	-----	-----	-----

Command code is 86H in error message, the highest bit 1 of 06H. If error code detail is 11H, it means the parameter is read only.

After responding to the error data receipt, master can revise the responding program via resending data frame or based on the error message responded by the inverter.

12.5.6 Details of 0x08 Circuit Diagnoses and Setting

Sub-function Code	Data Requested	Response Data	Indication of Sub-function
0000H	#data16	The same as the data requested	Circuit Diagnosis

13.6 Description of Control Command

Control Command 1(Register Address: 4000H or 7000H)

Data	Meaning	Data	Meaning
0000H	Disabled Command	0006H	Ramp to Stop
0001H	Forward Running	0007H	Coast to Stop
0002H	Reverse Running	0008H	Fault Reset
0003H	JOG Forward	0009H	+/- Input Switch
0004H	JOG Reverse	000AH	Not Used
0005H	Slave-inverter Stops	000BH	Not Used

Control Command 2(Register Address: 4000H)

Virtual Terminals from LSB to MSB are:

X1, X2, X3, X4, X5, X6, X7, VS, VF, IS, IF, Y1, Y2, R1.

Virtual Terminals		R1	Y2	Y1	IF	IS	VF	VS		X7	X6	X5	X4	X3	X2	X1
Bit	15	14	13	12	11	10	9	8	7	6	5	4	3	2	1	0

Inverter Status 1(Register Address: 4100H)

Data	Meaning	Data	Meaning
0000H	Parameter Setting	0004H	Slave-inverter Stops
0001H	Slave-inverter Runs	0005H	JOG Stop
0002H	JOG Running	0006H	Fault Status
0003H	Running in Autotuning	0007H	Factory Check

13.7 Example

Read primary numeric frequency setting (F0-07) of Inverter No.01, return 50Hz.

Transmitting Sequence	0	1	2	3	4	5	6	7	8	9
Data		01H	03H	20H	07H	00H	01H	3EH	0BH	
Receiving Sequence	0	1	2	3	4	5	6	7	8	
Data		01H	03H	02H	13H	88H	B5H	12H		

Write F0-07=30.00Hz, the setting value of primary numeric frequency of Inverter No.01.
(Recommended to Apply)

Transmitting Sequence	0	1	2	3	4	5	6	7	8	9
Data		01H	06H	70H	01H	0BH	B8H	C5H	88H	
Receiving Sequence	0	1	2	3	4	5	6	7	8	9
Data		01H	06H	70H	01H	0BH	B8H	C5H	88H	

Write F0-09 =5.00 seconds, the acceleration time 1 of Inverter No.01.

Transmitting Sequence	0	1	2	3	4	5	6	7	8	9
Data		01H	06H	00H	09H	01H	F4H	59H	DFH	
Receiving Sequence	0	1	2	3	4	5	6	7	8	9
Data		01H	06H	00H	09H	01H	F4H	59H	DFH	

Remarks:

For frequent modified function codes, the function code address +2000H is to prevent the EEPROM of inverter from being damaged.

Inverter Starts

Transmitting Sequence	0	1	2	3	4	5	6	7	8	9
Data		01H	06H	40H	00H	00H	01H	5DH	CAH	
Receiving Sequence	0	1	2	3	4	5	6	7	8	9
Data		01H	06H	40H	00H	00H	01H	5DH	CAH	

Inverter Stops

Transmitting Sequence	0	1	2	3	4	5	6	7	8	9
-----------------------	---	---	---	---	---	---	---	---	---	---

Data		01H	06H	40H	00H	00H	05H	5CH	09H	
Receiving Sequence	0	1	2	3	4	5	6	7	8	9
Data		01H	06H	40H	00H	00H	05H	5CH	09H	

13.8 Troubleshooting of common communication

Set frequency by communication, the inverter trips EED fault.

Cause:Frequency is changed by communication address 0007H of F0-07, as EEPROM is frequently stored for more than the erasure times allowed, it gets damaged.

Solution: For the code frequently modified, please change address +2000H of this code. For example, address 2000H of F0-07 is changed as 2007H.