



Soft Sterter Motor Controller. Specification



Content

I.	Function introduction.....	P.1
II.	General characteristic.....	P.2
III.	Specification.....	P.3
IV.	Installation attention of SMC	P.4
V.	Application and setting of SMC.....	P.6
VI.	Starting way.....	P.7
VII.	The overload electric current adjust and explain.....	P.8
VIII.	Standard overload electric current of leave the factory setting list.....	P.10
IX.	Control way.....	P.11
X.	The function of the faceplate is explained.....	P.12
XI.	Comparison drawing of SMC ordinary start current	P.14
XII.	Environment characteristic.....	P.15
XIII.	Attention.....	P.16

I. Function introduction.

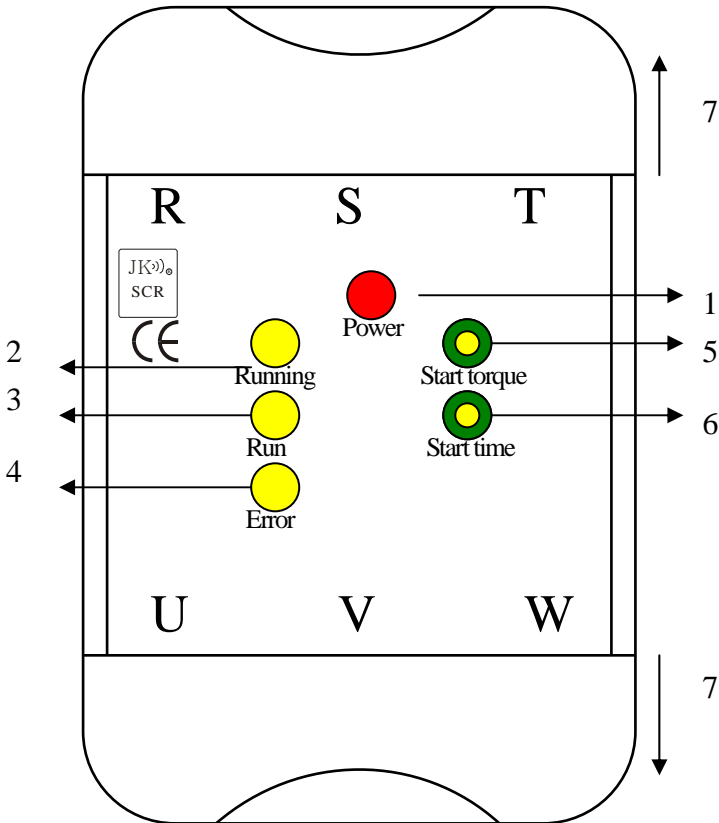

1. Auxiliary voltage indicator lamp.
2. Running indicator lamp.
3. Run and finish indicator lamp.
4. Error indicator lamp. (Overload 、 Loss phase 、 Motor seize 、 Over heating)
5. Start torque indicator lamp. (100%~500%)
6. Start time indicator lamp. (1~40 Sec.)
7. The top cover and below cover can be according to the instruction press and push open.

- 1-1.Torque and time can be adjusted: make starting smoothly and stably.
- 1-2.No connection switch: avoid the industrial danger caused by spark, and the problem of tear and wear, and use-life due to connection.
- 1-3.Easy wiring: only need 3 guide wires connect to motor, includes control power, easy install; also can connect with PLC, let the operation to be more perfect.
- 1-4.Display of LED diagnosis : 220V 10 HP & 380V 15 HP have CT electronic check protector with the protection of overloading, phase loss, overheat, and big current.
- 1-5.Have the function of KICK START & FIX CURRENT START, let the whole machine to be more perfect.(220V 10 HP & 380V 15 HP & 440V 15 Hp have the function mentioned above)
- 1-6.” By PASS ” Circuit design can be offered, add cooling effect to extend use life of parts.
- 1-7.With showing instrument of running condition and self-diagnosis of breakdown, the items showed include power direction, running condition, and breakdown, etc. at least.
- 1-8.This controller has CT electronic protector : the protection of overload, loss phase, motor block, over heating, high sensitivity, without heating effect, not influenced by the temperature around.
- 1-9.The controller has three phases and 3 wires’ SCR to transform control power.
- 1-10.This starter starting tool is tally with the specification of CE, IEC60947-4-2 standard.

II. General characteristic.

2-1.

Main power voltage:	220/380/440/460~480VAC \pm 10%
Assistance voltage:	220VAC \pm 15% (Leave the factory standard, If need to alter it for 110VAC, please tell business personnel first.)
Start way:	Dry contact point. (Add it in 11 and 12 these and two points)
Work frequency:	50 ~ 60 Hz \pm 5%
Highest peak pressure proof:	600VAC or 1200VAC ~ 1600VAC
Start time:	1 ~ 40 seconds
Torque adjustment:	100 ~ 500%
Work around temperature:	- 10°C ~ 45°C
Relative humidity:	93 % RH without dew.

III. Specification.

3-1.Type chooses matter needing attention.

Rated current	Rated voltage	HP	Rated voltage	HP	Rated current	Rated voltage	HP
	208~220VAC		380~440VAC			460~480VAC	
7A			SMC930030	3HP	7A	SMC940050	5HP
10A	SMC920030	3HP	SMC930050	5HP	10A	SMC940075	7.5HP
15A	SMC920050	5HP	SMC930075	7.5HP	15A	SMC940100	10HP
22A	SMC920075	7.5HP	SMC930100	10HP	22A	SMC940150	15HP
28A	SMC920100	10HP	SMC930150	15HP			
35A			SMC930200	20HP	28A	SMC940200	20HP
42A	SMC920150	15HP	SMC930250	25HP	35A	SMC940250	25HP
55A	SMC920200	20HP	SMC930300	30HP	42A	SMC940300	30HP
70A	SMC920250	25HP	SMC930400	40HP	55A	SMC940400	40HP
82A	SMC920300	30HP	SMC930500	50HP	70A	SMC940500	50HP
105A	SMC920400	40HP	SMC930600	60HP	82A	SMC940600	60HP
135A	SMC920500	50HP	SMC930750	75HP	105A	SMC940750	75HP
155A	SMC920600	60HP	SMC931000	100HP	135A	SMC941000	100HP
185A	SMC920750	75HP	SMC931250	125HP	155A	SMC941250	125HP
250A	SMC921000	100HP	SMC931500	150HP	185A	SMC941500	150HP
280A			SMC931750	175HP	250A	SMC941750	175HP
300A	SMC921250	125HP	SMC932000	200HP	280A	SMC942000	200HP
360A	SMC921500	150HP	SMC932500	250HP	300A	SMC942500	250HP
420A	SMC921750	175HP	SMC933000	300HP	360A	SMC943000	300HP
					420A	SMC943500	350HP
500A	SMC920500A		SMC930500A		500A	SMC940500A	
560A	SMC920560A		SMC930560A		560A	SMC940560A	
620A	SMC920620A		SMC930620A		620A	SMC940620A	
750A	SMC920750A		SMC930750A		750A	SMC940750A	
930A	SMC920930A		SMC930930A		930A	SMC940930A	
1100A	SMC921100A		SMC931100A		1100A	SMC941100A	

IV. Installation attention of SMC.

4-1. Ventilation and Cooling.

SMC must be placed at the place with good ventilation, and the temperature of the place can't be higher than 45°C, and lower than -10°C. SMC itself will cause the heat, so, please install in the place with good ventilation, and keep 10 cm from the article next to it for cooling.

4-2.Attention of installation:

4-2-1.Our company 380~440VAC products, setting of the overload electric current is all to regard 380VAC as leave the factory setting value, Used in 440VAC and please tell first, adjust overload setting value, otherwise the overload function is unable to protect.

4-2-2.This product is designed to the standard of starting 20 times per hour equally, SMC class must be raised if starting times higher than the value setting.

4-2-3.Please confirm input wire is R.S.T., output wire is motor wire U.V.W. when supply the power to test the machine. Wire breakdown doesn't include in the field of guarantee due to input wire and output wire in reverse.

4-2-4.When install in the control box, please make a window on up side and down side in order to cool air in from down side, and hot air out from up side, and please place the filter net on up side to prevent the dust or waste in, and clean the filter net regularly to avoid the filter net block.

4-2-5.Add the fans if the temperature in the box over 45°C to enhance air convection, keep the temperature in the box lower than 45°C for the best running condition.

4-2-6.We suggests using electro-magnetic contactor to isolate when use SMC, let SMC circuit and electric function can be broke completely and reliably for the security. Warning plate should be hanged if without this equipment.

4-2-7. If use the static power factor to correct the device , be sure to install to input side, can not install the power factor compensator on output side .

 When install, should confirm the voltage used same as the voltage listed on the starter. (e.g. : 220v can't use 380V,.....and so on.) And also need to check the loading current not over rated current.

 When motor itself has capacitor with power factor improvement on SMC, the capacitor must be placed at R.S.T. of SMC, because SMC will be breakdown if place the capacitor at U.V.W. of SMC.

(No include in the field of guarantee if SMC breakdown due to the condenser placed at wrong side.)

Wrong connection of the capacitor.

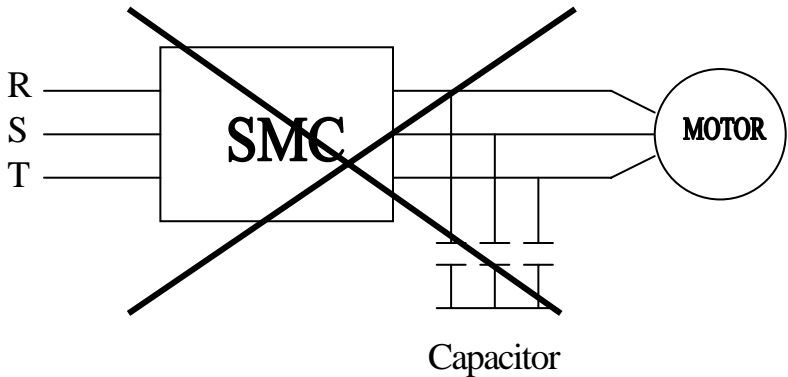

Right connection of the capacitor.

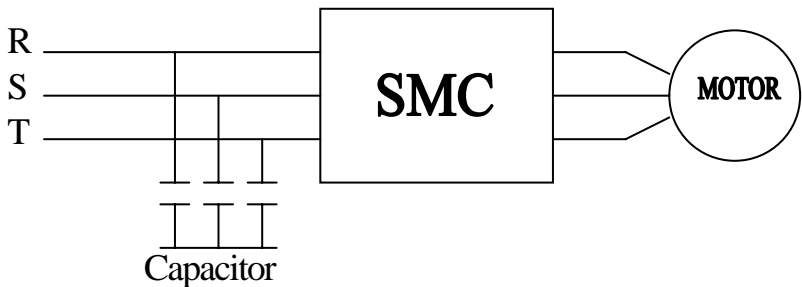

V. Application & setting of SMC.

5-1. Time and torque adjustment when starting, depends on motors' kinds. There are light and heavy 2 kinds.

5-2. Adjust torque and time of SMC according to real loading requirement. The way is that open the transparent cover with screw driver, and adjust torque value first (adjust clockwise, and torque add ; and adjust counterclockwise, lower torque), let the motor start smoothly, continue to adjust TIME value if without buzzing, and get the correct starting time.

5-3. Coordinate with soft KICT START with current limit 2 ways to start, or use separately for the machine with big inertia and need linear start, e.g.: blower.

5-4. No matter any condition, starter will run full voltage when motor reaches fast to running speed, so we suggest to adjust and test with 2 ways under if you do not know the loading.

5-4-1. Motor starting slowly and fast depends on torque adjustment.

5-4-2. The time of motor full pressure starting depends on time adjustment.

5-5 Setting of SMC

5-5-1. Buffer starting time adjust button: Buffer starting time long and short setting.

5-5-2. Buffer starting torque adjust button: Turning moment setting of voltage's initial value.

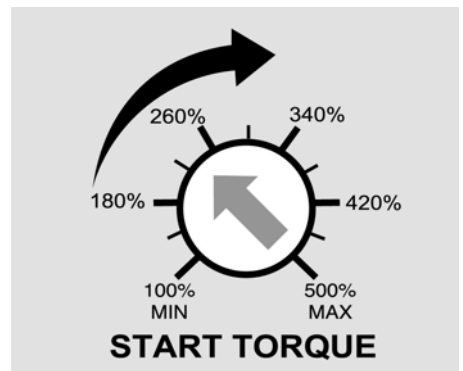
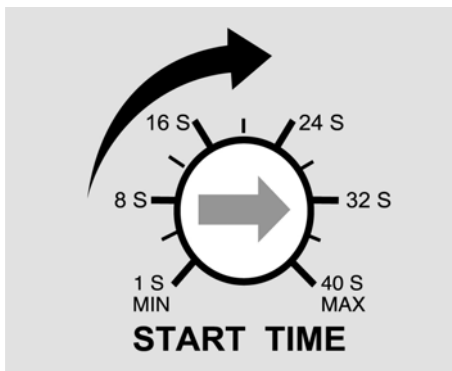

VI. Starting way.

6-1.Slope Starting

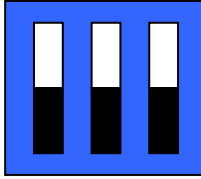

“1” “2” “3” turn down.

6-2.Current-limiting Starting.

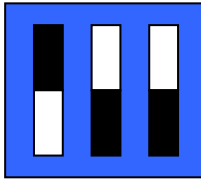

“1” turn up, “2” “3” turn down.

6-3.Current-limiting & Kick Start.

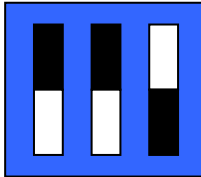

“1” “2” turn up, ”3” turn down..

VII. The overload electric current adjust and explain.

7-1.As " soft start motor controller " start rapidly or stop the phenomenon rapidly when using, the reason:

7-1-1. Motor operates in the electric current and is smaller than soft start motor controller and establish more than 30% of electric current.

7-1-2. The motor is smaller much than soft start motor controller in load while operating.

E.G.: Motor load is 1HP, soft start motor controller is 10HP.

7-1-3. It is the same as motor load to use soft start motor controller, but the motor operates the electric current and soft start motor controller and establishes the electric current and differs by more than 30%.

While finding that there are above-mentioned reasons. Need to adjust soft start motor controller overload electric current and establishing the parameter.

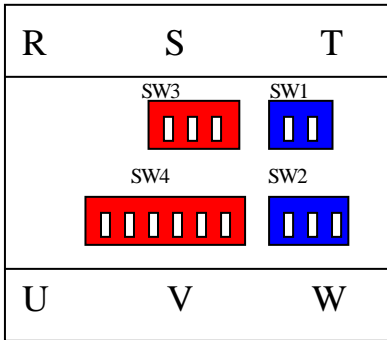

Switches explaining:

SW1: The torque controlling.

SW2: Various kinds of starting model.

SW3: Overload electric current multiple are established.

SW4: The amperage of electric current of the overload is established.

Sketch map within SMC.

7-2. The torque controlling: If the motor has situation of shaking while starting, need to adjust switches (SW1), switches establishes the way as follows:



7-3. The electric current multiple of the overload (SW3) establishes the way as follows:

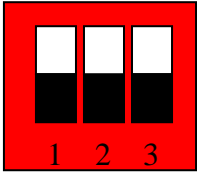

0.5 Times

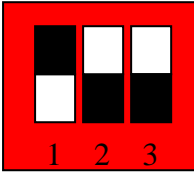

1 Times

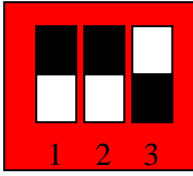

2 Times

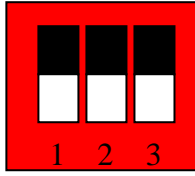

3 Times

7-4. The amperage of electric current of the overload (SW4) establishes the way as follows:

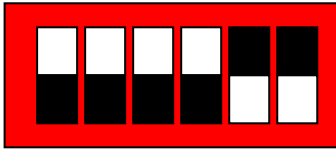

Amperage:

1 2 4 8 10 26

Constant summation "Annotate 1".



Annotate 1: If you measure V phase full load electric current it is 30A, must be multiplied by safety coefficient of 1.2 times, equal 36A, go to setting overload amperage. Like picture above.

Annotate 2: The aforesaid setting and is only suitable for using under 220V/40HP and 380V/75HP, if exceed horsepower of this range, please get in touch with the distributor or our company technical staff as quickly as possible.

VIII. Standard overload electric current of leave the factory setting list.

8-1.

HP	220V	Multiple	380V	Multiple	440V	Multiple	480V	Multiple
10HP	28A	1						
15HP	42A	1	26A	1	46A	0.5	40A	0.5
20HP	28A	2	32A	1	28A	1	26A	1
25HP	36A	2	42A	1	38A	1	34A	1
30HP	40A	2	26A	2	46A	2	42A	1
40HP	36A	3	34A	2	30A	2	28A	2
50HP			42A	2	38A	2	34A	2
60HP			46A	2	42A	2	36A	2
75HP			40A	3	36A	3	48A	3

Propose that motor overload electric current value setting the way:

1. Please that data plate label to fully loaded with electric current value multiply by 1.1 times set for with motor.
 2. If does not know that the motor is fully loaded with electric current value, please measure motor S phase with clamp meters, electric current value got is multiply by 1.2 times and setting.
- 2-1. **The motor has not overloaded or has been fully loaded with, could use this explanation.**



Matter needing attention: Use SMC-P, need to pay attention to the motor not to exceed specified electric current value that SMC-P permit while operating electric current value, if overload to use, our company will refuse to guarantee.

IX. Control way.

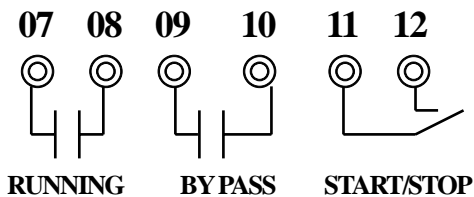
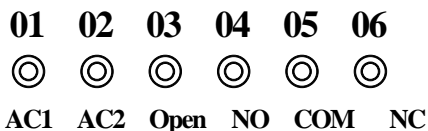

9-1.AC1、AC2 (01、02) : Assistance voltage AC 220V or 110V

9-2.Open (03) : Empty.

9-3.NO、COM、NC (04、05、06) : Output point abnormal (240/10A) offer 1A, 1B.

9-4.Running (07、08) : Output point when starting, output point can change from 1A to 1B.

9-5.By Pass (09、10) : Output point when starting finish, output point can change from 1A to 1B.

9-6.Start / Stop (11、12) : Starting/stopping control point.



Annotate 1: 04、05、06 Output point of capacity (240VAC / 10A) .

X. The function of the faceplate is explained.

10-1. LED illustration

10-1-1. Power : When AC1 , AC2 is feeding AC 220V 50/60 Hz, the power LED light up.

10-1-2. Run : When the starting finish, a run LED light up.

10-1-3. Running : include starting, operating, stopping.

10-1-4. Error :

- A. It includes the protection of overload, loss phase, motor black, over heating.
- B. If the inspection is abnormal, an error lamp will light up.
- C. When you eliminate error light. First of all, you must eliminate abnormal cause then you can add assistance voltage.

10-2. Abnormal light illustration:

There are four type protections in the machine.

Under to illustration:

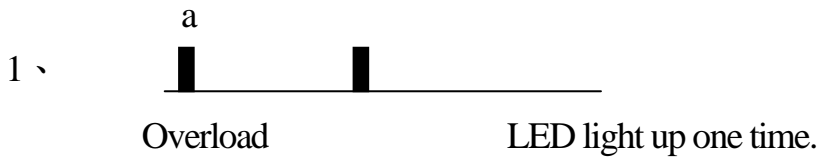

The breakdown clearing explaining: Please consult page 8~10.

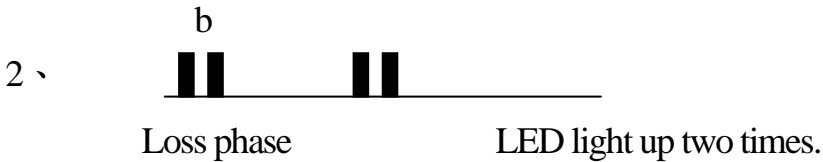

The breakdown clearing explaining: Please check whether there is power input in the electric three phases of source , and check whether to install the mistake in proper order in motor load or not.



The breakdown clearing explaining: Whether checking the motor has things that are seize, whether checking the motor has things that are seize, or the piping has phenomenon of shaking while starting, can jump seize state , Please consult page. setting torque control.

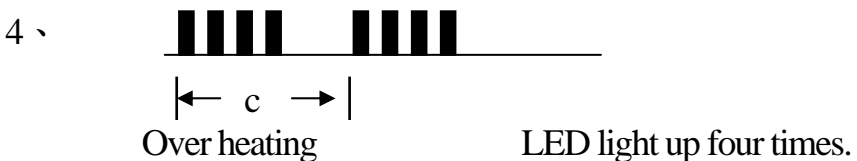

The breakdown clearing explaining: When install in the control box, please make a window on up side and down side in order to cool air in from down side, and hot air out from up side, and please place the filter net on up side to prevent the dust or waste in, and clean the filter net regularly to avoid the filter net block.



a: Times of cycle is 0. 25 Sec.

b: Times of cycle is 0. 25 Sec.

c: One abnormal time of cycle is 3 Sec.

XI. Comparison drawing of SMC ordinary start current.

11-1.

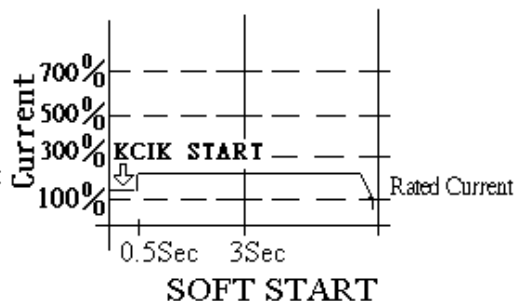
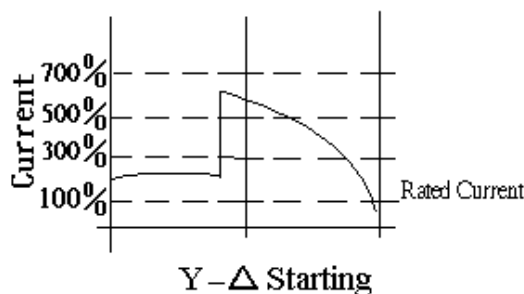
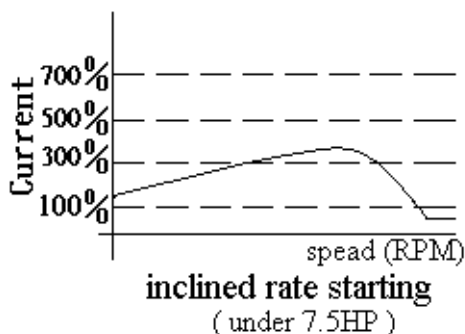
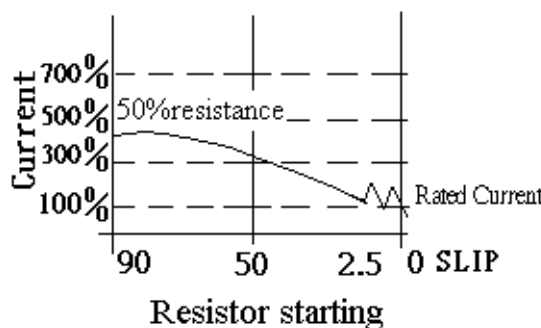
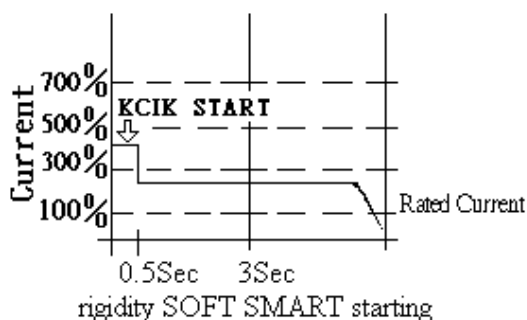
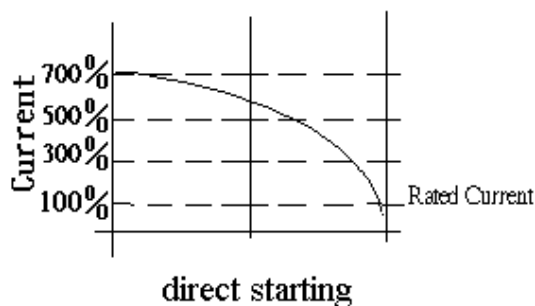

XII. Environment characteristic.

Operation position:	Indoor without dust and corrosive air.
Work position:	Vertical.
Relative humidity:	Over 45% , 93% RH without dew.
Work's week temperature:	-10°C ~ under 45°C.
Frequency:	50Hz or 60Hz , auto-adjust.
Power , voltage 3 ϕ :	220VAC \pm 10% 380VAC \pm 10% 440VAC \pm 10% 460~480VAC \pm 10%
Vibration:	Under 0.5G
Height:	Under 1,000m.
Voltage directed on motor:	200V ~ 240V, 380V ~ 440V, 460V ~ 480V.

XIII. Attention.

13-1. This product has the function of overload protection. Please check voltage of motor, (ex: 220V, 380V, 440V...etc) and full voltage of motor listed similar as the voltage listed in our catalogue (in principle, error can be -20% ~ +5%), and write on the order if plan to raise the class in order to setting before leaving the plant, or also can add overload protector by yourself.

E.G: Please let's know when you use SMC 100 HP in motor 75 HP, or add overload protector.

13-2. Concerning our product of 380V ~ 440V, the 380V is full current standard setting when leaving the plant, please let's know what you use 440V. In order to, change setting before leaving the plant. Otherwise, the overload function will lose efficacy. It become without overload protection. When you use it, you should pay attention reference of manual.

13-3. Our company SMC electric current setting value, environment temperature is less than 45°C in Centigrade, can operate for a long time. But need to pay attention if motor starting times are high frequently, the SMC must raise one level.



Annotate 1: An hour is started 20 or more times or heat sink temperature exceeds 85°C Centigrade, need upgrading.



English Edition v10. 10
October.21.2010 Made.